

1.2A Deuropbouw en maatvoering Vlakke Deuren

Kegro Deuren hanteert 1 modelnummer voor de afmetingen hoog, midden en laag. De Glasmaat staat hierbij vast.

Uitvoering in 3 hoogtes:

- <2200mm = Laag model
- 2201 – 2400mm = Midden model
- >2401mm = Hoog model
- De minimale maat is veelal 1900mm

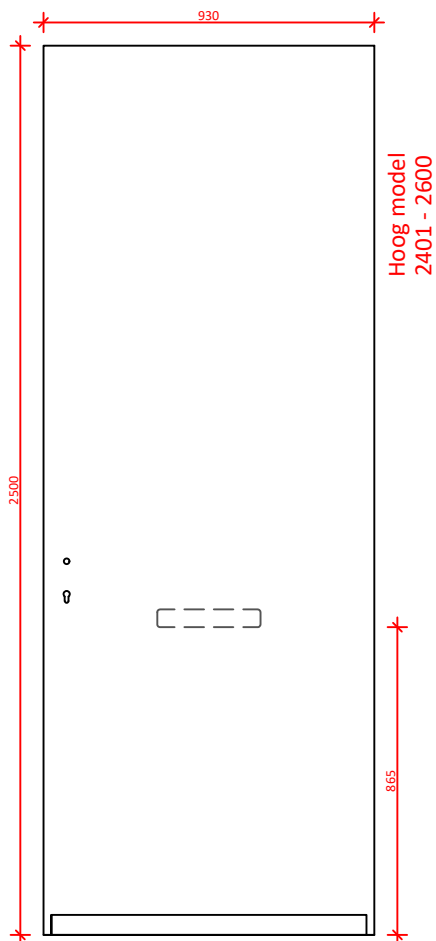
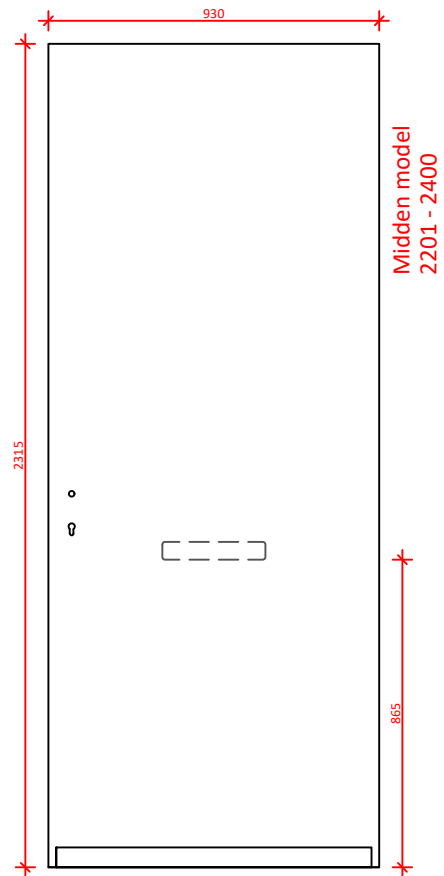
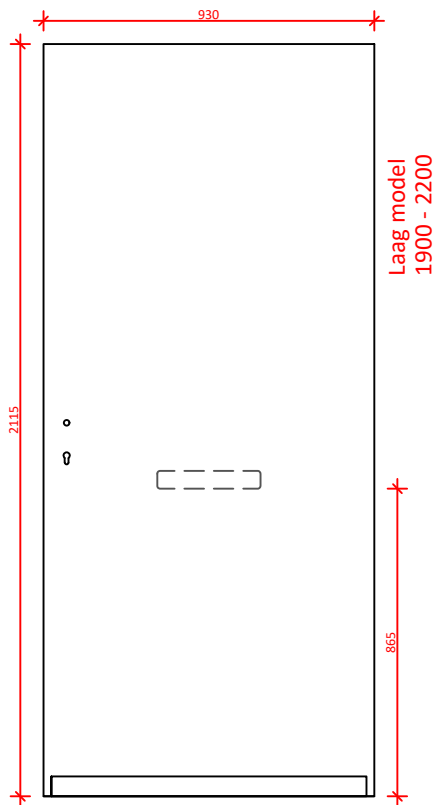

| | | | | | |
|--------|------------|---------------|---------------------|--------|------------|
| DATUM: | GEWIJZIGD: | CALCULATIENR: | TEKENINGNR: 9101 | MODEL: | HOUTSOORT: |
|--------|------------|---------------|---------------------|--------|------------|

| | | | | | |
|-----------------------|---------------------------------------------------|--|--|-------------|--|
| KEGRO DEUREN | KLANT/PROJECT: overzicht modellen 9101 L1 - R4 | | | DCM NUMMER: | |
|-----------------------|---------------------------------------------------|--|--|-------------|--|

| | | | | |
|-----------|---------|-----------------|------------|----------|
| AANVRAAG: | SCHAAL: | GETEKEND: MN | LEVERWEEK: | 1.2a P.2 |
|-----------|---------|-----------------|------------|----------|

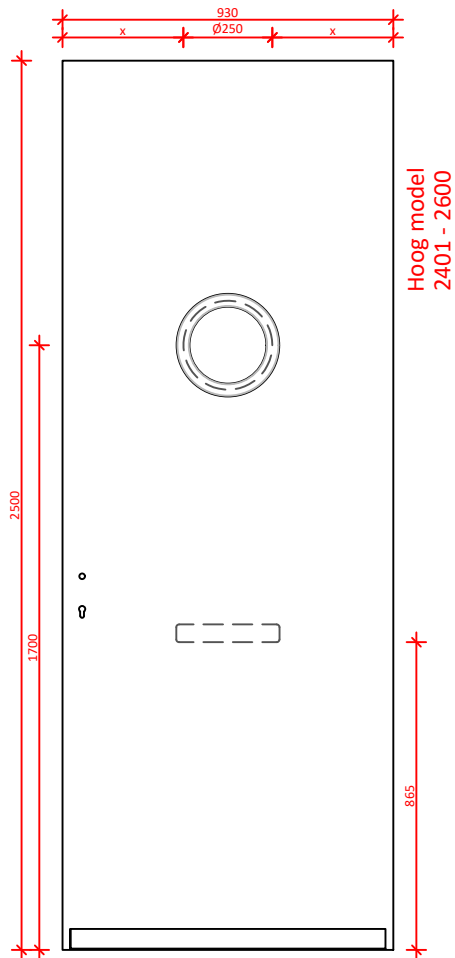
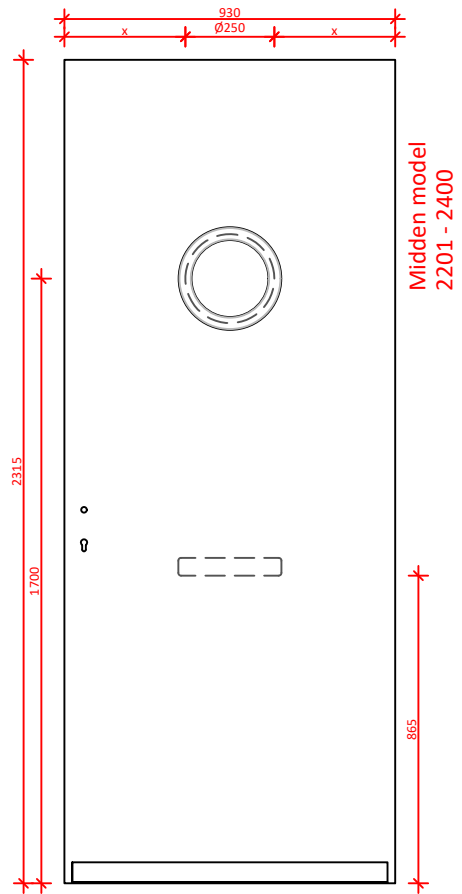
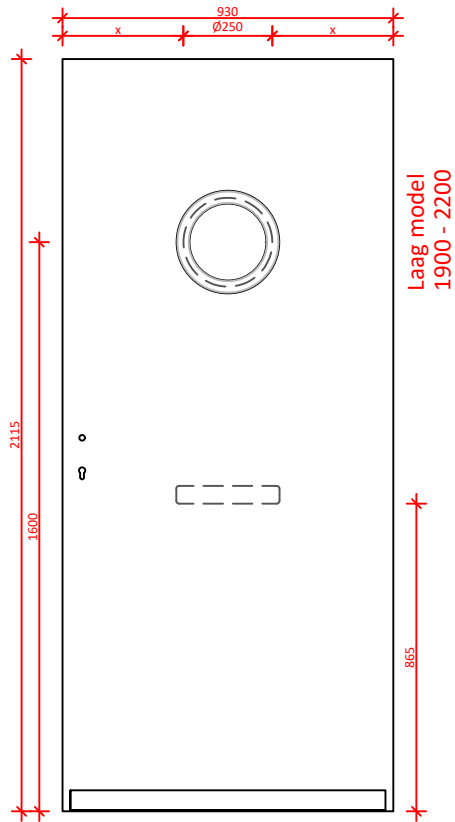

| | | | | | |
|--------|------------|---------------|-------------|-----------------|------------|
| DATUM: | GEWIJZIGD: | CALCULATIENR: | TEKENINGNR: | MODEL: 9152N | HOUTSOORT: |
|--------|------------|---------------|-------------|-----------------|------------|

| | | | | |
|------------------------------------------------------------------------------------|--------------------------------------------|--|--|-------------|
|  | KLANT/PROJECT: overzicht modellen 9152N | | | DCM NUMMER: |
|------------------------------------------------------------------------------------|--------------------------------------------|--|--|-------------|

| | | | | |
|-----------|---------|-----------|------------|----------|
| AANVRAAG: | SCHAAL: | GETEKEND: | LEVERWEEK: | 1.2a P.3 |
|-----------|---------|-----------|------------|----------|

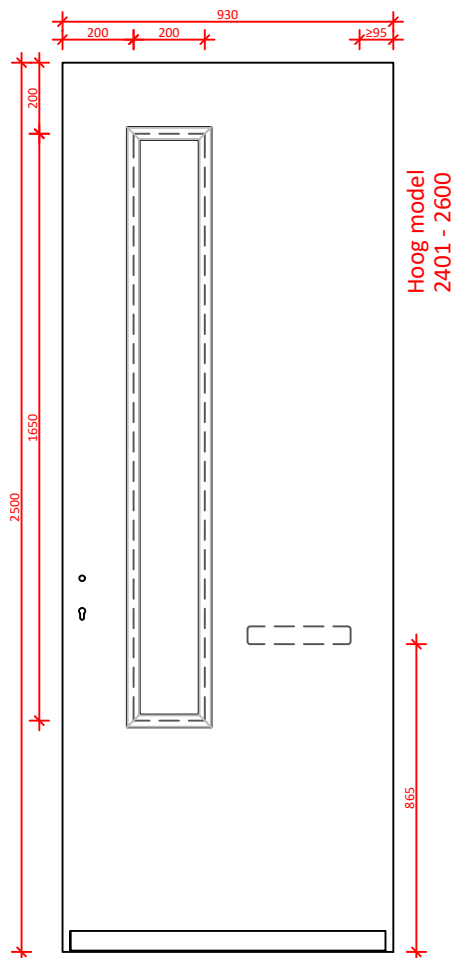
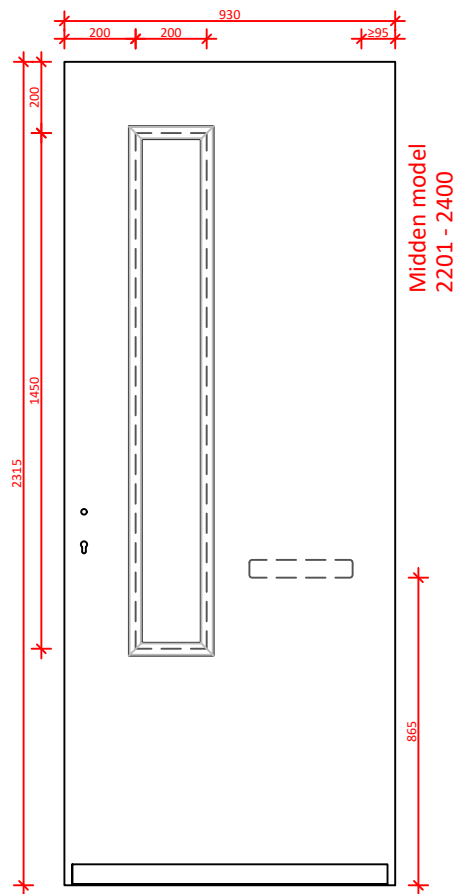
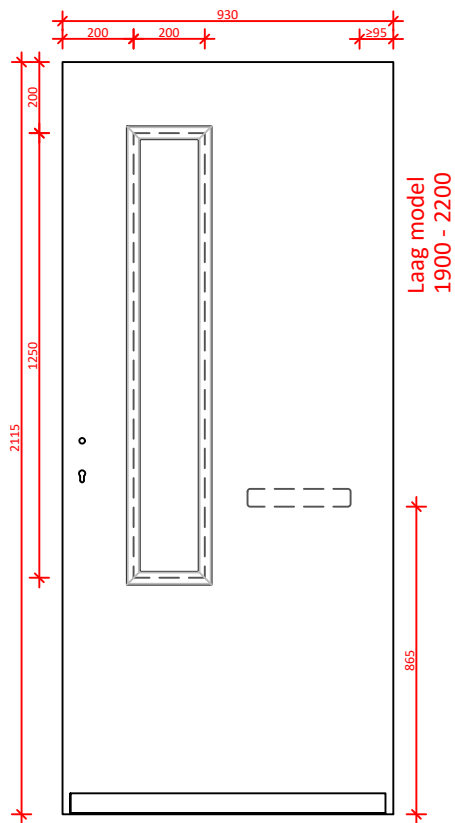

| | | | | | |
|--------|------------|---------------|-------------|-----------------|------------|
| DATUM: | GEWIJZIGD: | CALCULATIENR: | TEKENINGNR: | MODEL: 9153N | HOUTSOORT: |
|--------|------------|---------------|-------------|-----------------|------------|

| | | | | |
|------------------------------------------------------------------------------------|----------------------------------------------------|--|--|-------------|
|  | KLANT/PROJECT: overzicht modellen 9153N L1 - R4 | | | DCM NUMMER: |
|------------------------------------------------------------------------------------|----------------------------------------------------|--|--|-------------|

| | | | | |
|-----------|---------|-----------------|------------|----------|
| AANVRAAG: | SCHAAL: | GETEKEND: MN | LEVERWEEK: | 1.2a P.4 |
|-----------|---------|-----------------|------------|----------|

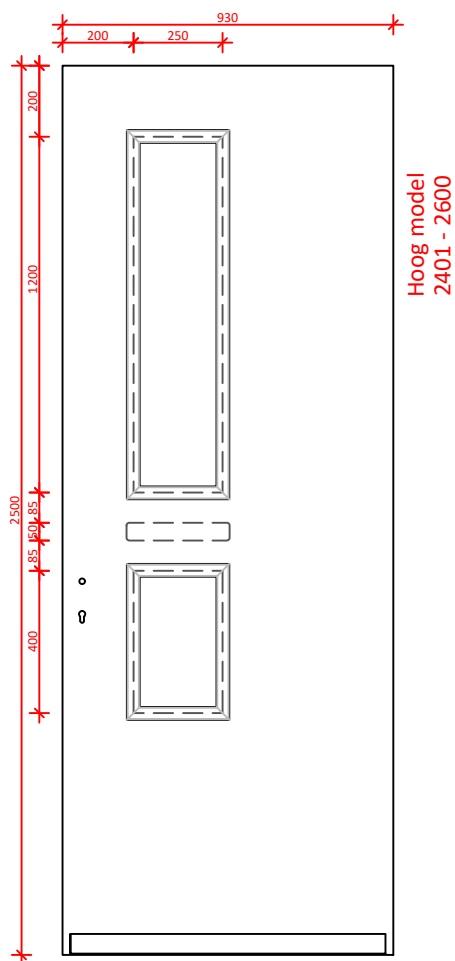
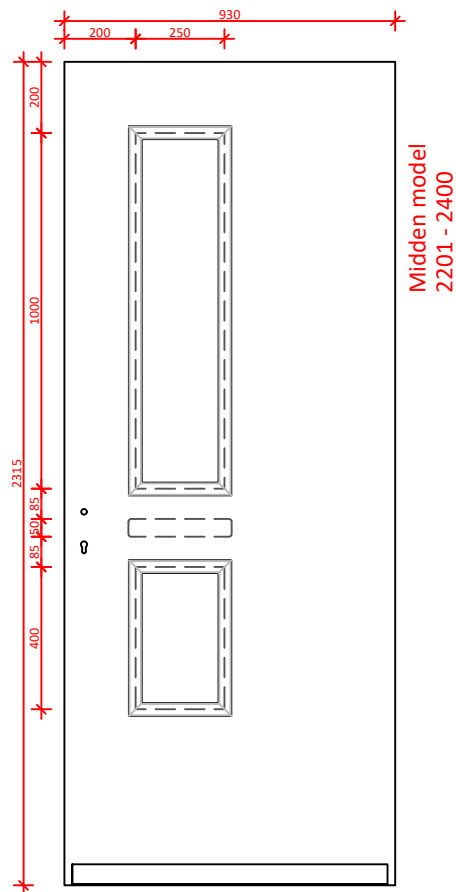
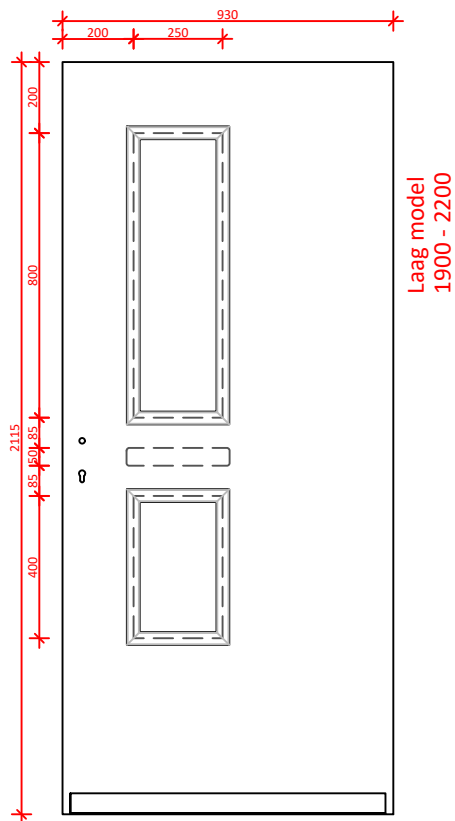

| | | | | | |
|--------|------------|---------------|-------------|-----------------|------------|
| DATUM: | GEWIJZIGD: | CALCULATIENR: | TEKENINGNR: | MODEL: 9154N | HOUTSOORT: |
|--------|------------|---------------|-------------|-----------------|------------|

| | | | | |
|--|----------------------------------------------------|--|--|-------------|
| | KLANT/PROJECT: overzicht modellen 9154N L1 - R4 | | | DCM NUMMER: |
|--|----------------------------------------------------|--|--|-------------|

| | | | | |
|-----------|---------|-----------------|------------|----------|
| AANVRAAG: | SCHAAL: | GETEKEND: MN | LEVERWEEK: | 1.2a P.5 |
|-----------|---------|-----------------|------------|----------|

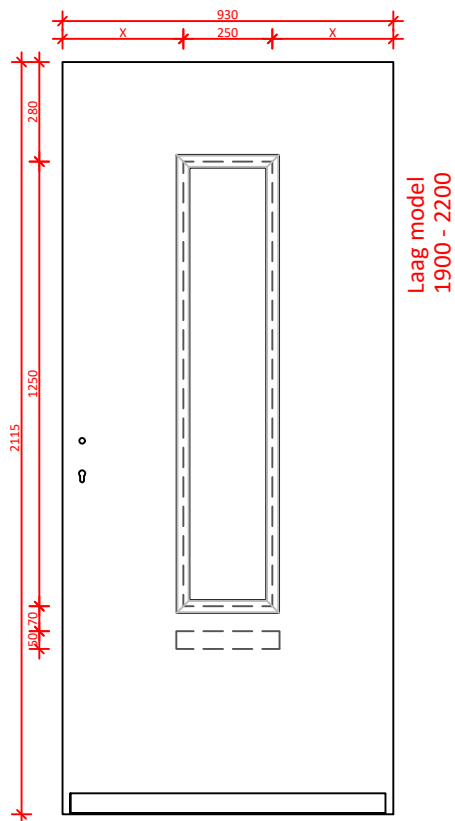

Laag model
1900 - 2200

LET OP!! briefsleuf niet vlg PostNI norm.

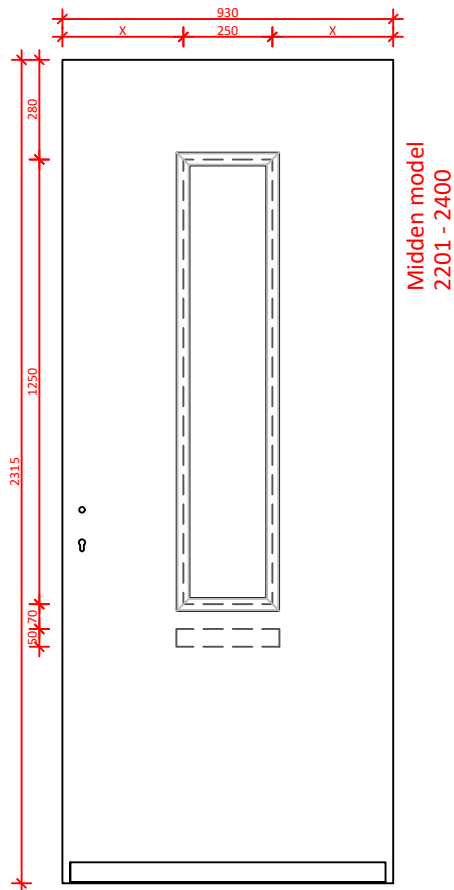

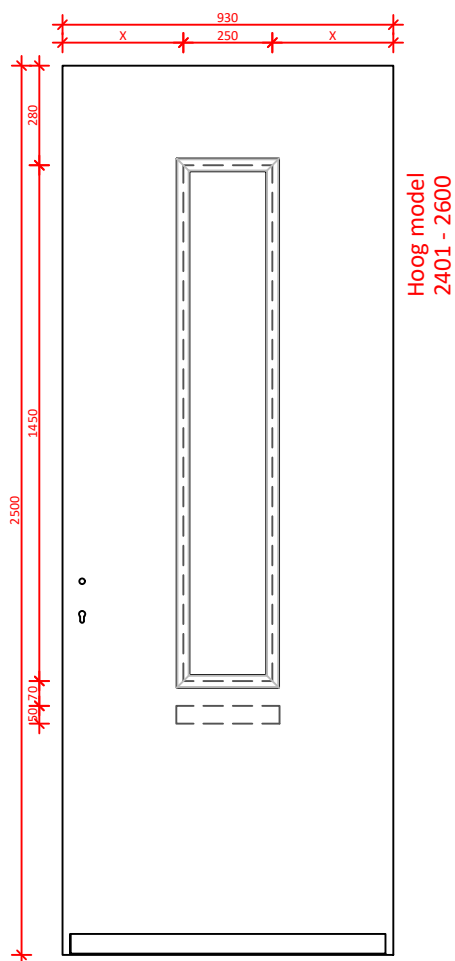

Midden model
2201 - 2400

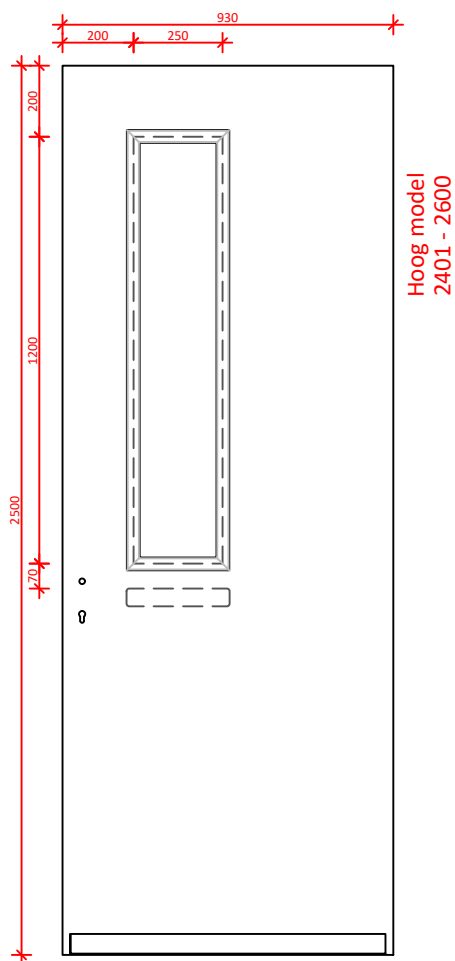
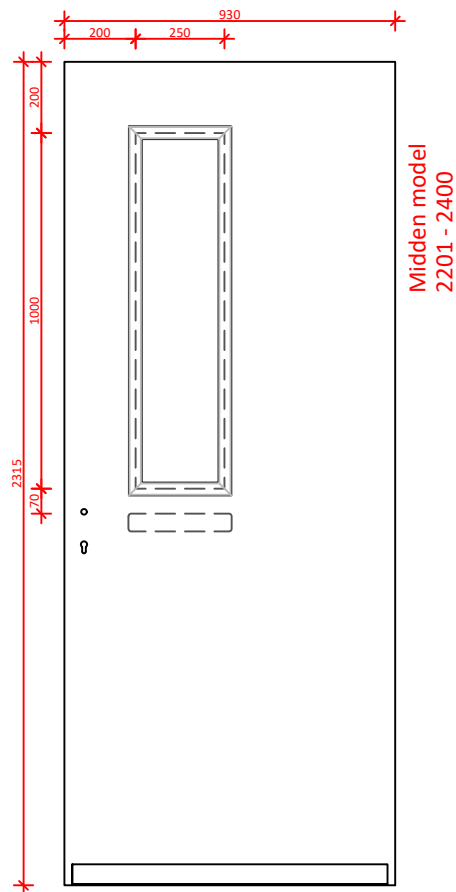
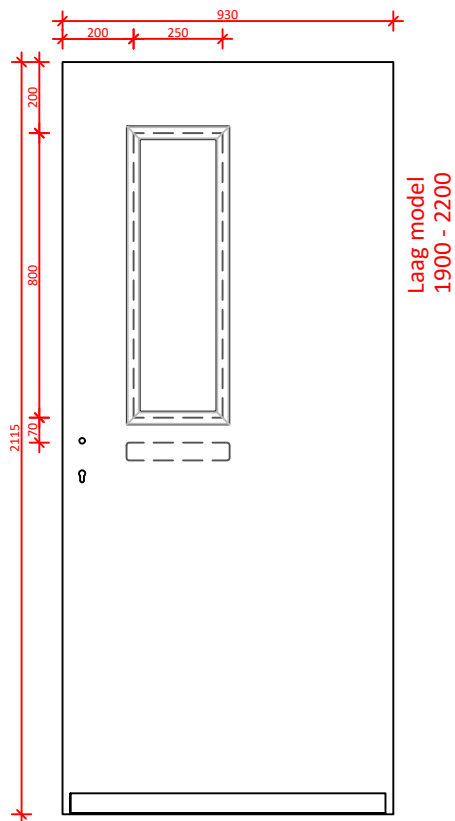

Hoog model
2401 - 2600

| | | | | | |
|------------------------------------------------------------------------------------|------------|---------------|--------------------------------------------|---------|-----------------|
| DATUM: | GEWIJZIGD: | CALCULATIENR: | TEKENINGNR: 9155N | MODEL: | HOUTSOORT: |
|  | | | KLANT/PROJECT: overzicht modellen 9155N | | DCM NUMMER: |
| | | | AANVRAAG: | SCHAAL: | GETEKEND: MN |



| | | | | | |
|------------------------------------------------------------------------------------|------------|---------------|----------------------------------------------------|---------|-----------------|
| DATUM: | GEWIJZIGD: | CALCULATIENR: | TEKENINGNR: 9156N | MODEL: | HOUTSOORT: |
|  | | | KLANT/PROJECT: overzicht modellen 9156N L1 - R4 | | DCM NUMMER: |
| | | | AANVRAAG: | SCHAAL: | GETEKEND: MN |

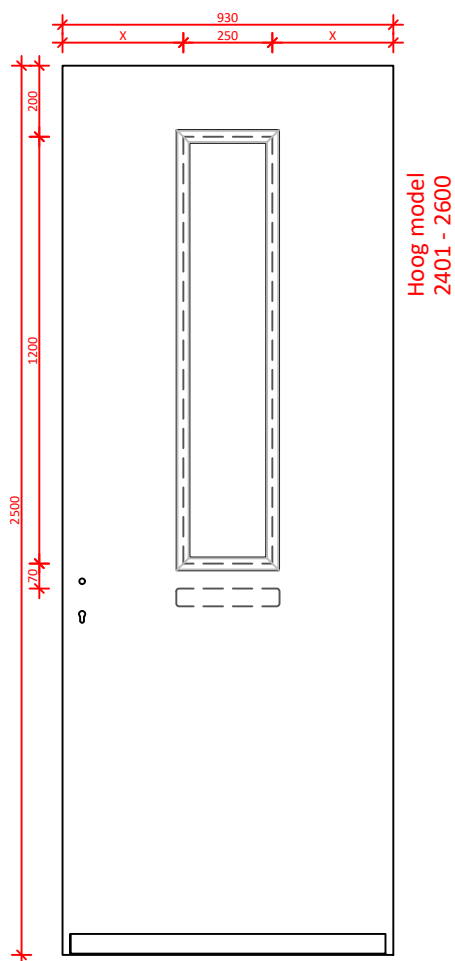
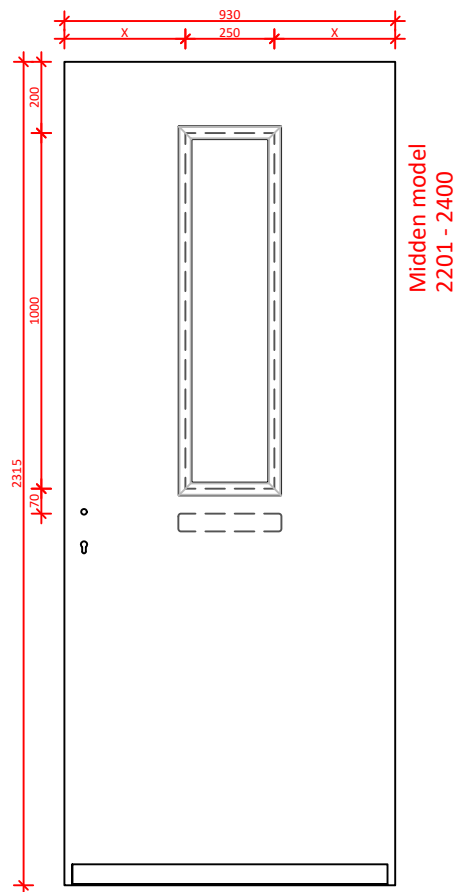
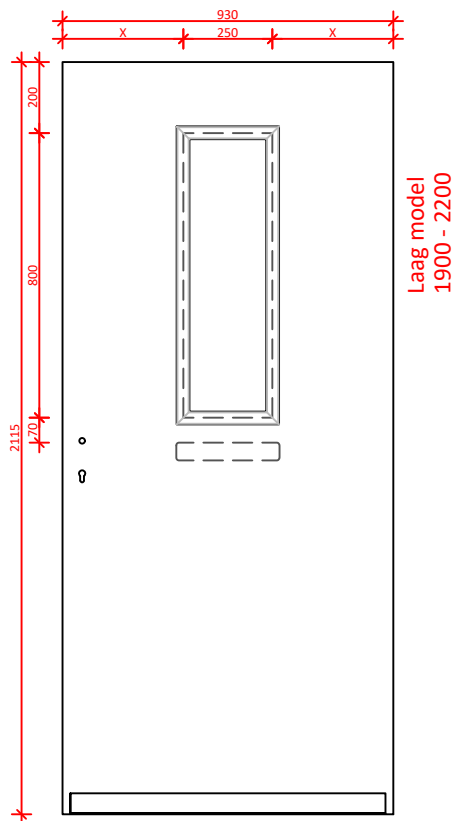

| | | | | | |
|--------|------------|---------------|----------------------|--------|------------|
| DATUM: | GEWIJZIGD: | CALCULATIENR: | TEKENINGNR: 9157N | MODEL: | HOUTSOORT: |
|--------|------------|---------------|----------------------|--------|------------|

| | | | | |
|-----------------------|--------------------------------------------|--|--|-------------|
| KEGRO DEUREN | KLANT/PROJECT: overzicht modellen 9157N | | | DCM NUMMER: |
|-----------------------|--------------------------------------------|--|--|-------------|

| | | | | |
|-----------|---------|-----------------|------------|----------|
| AANVRAAG: | SCHAAL: | GETEKEND: MN | LEVERWEEK: | 1.2a P.8 |
|-----------|---------|-----------------|------------|----------|

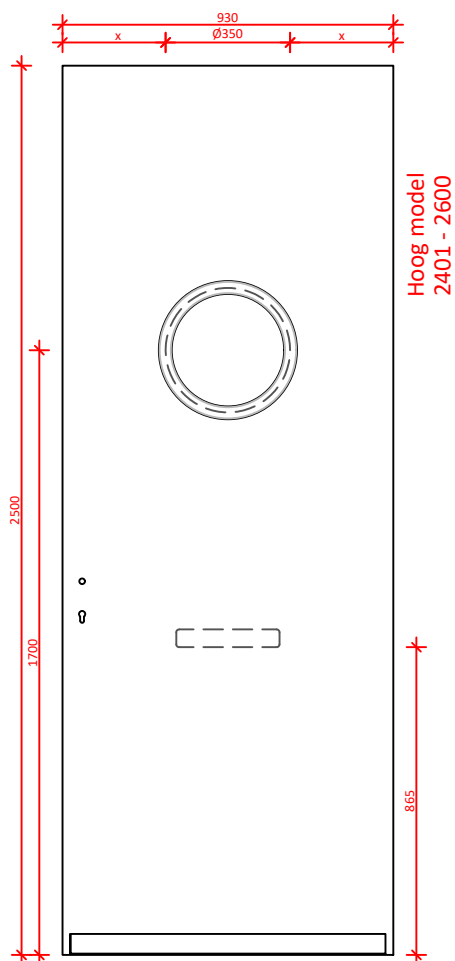
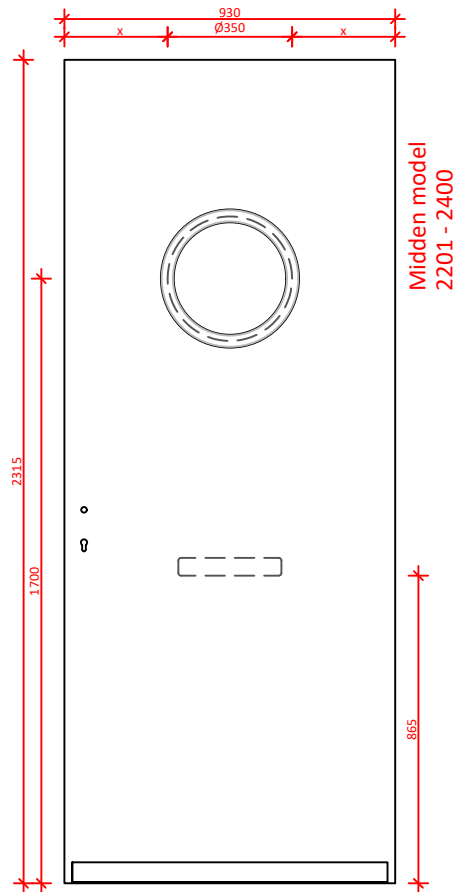
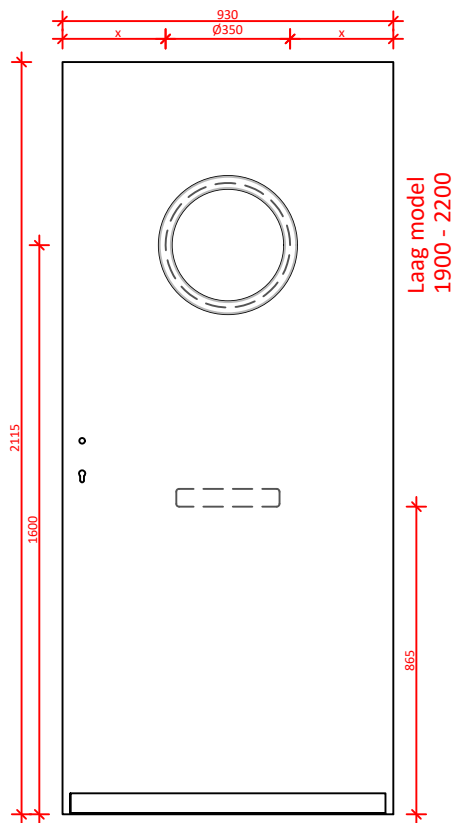

| | | | | | |
|--------|------------|---------------|----------------------|--------|------------|
| DATUM: | GEWIJZIGD: | CALCULATIENR: | TEKENINGNR: 9162N | MODEL: | HOUTSOORT: |
|--------|------------|---------------|----------------------|--------|------------|

| | | | | |
|-----------------------|--------------------------------------------|--|--|-------------|
| KEGRO DEUREN | KLANT/PROJECT: overzicht modellen 9162N | | | DCM NUMMER: |
|-----------------------|--------------------------------------------|--|--|-------------|

| | | | | |
|-----------|---------|-----------|------------|----------|
| AANVRAAG: | SCHAAL: | GETEKEND: | LEVERWEEK: | 1.2a P.9 |
|-----------|---------|-----------|------------|----------|

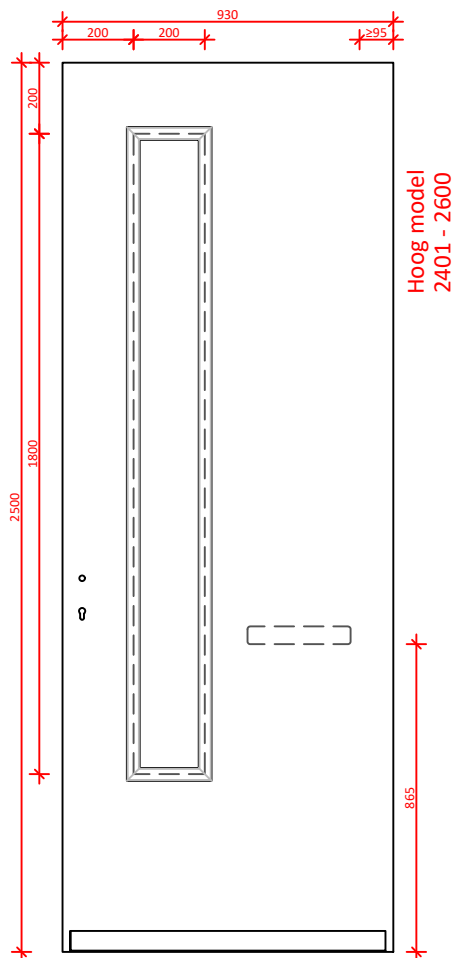
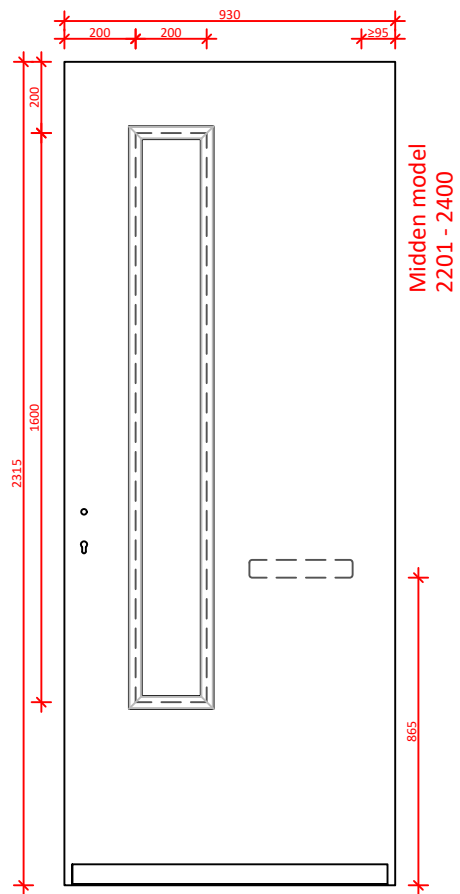
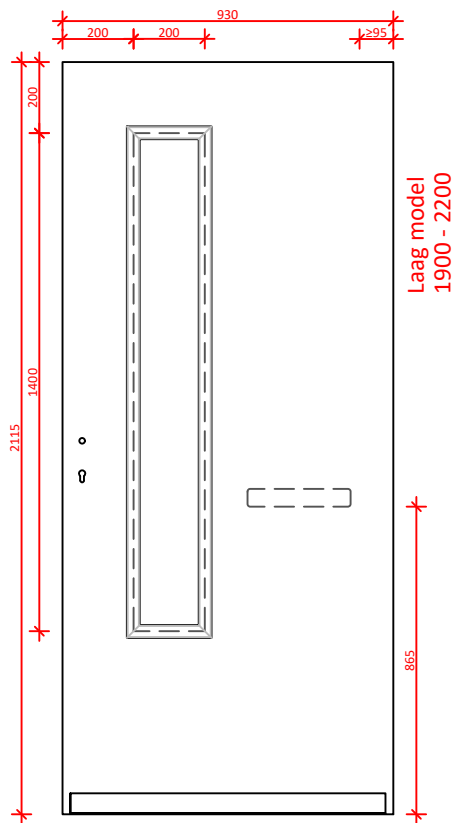

| | | | | | |
|--------|------------|---------------|----------------------|--------|------------|
| DATUM: | GEWIJZIGD: | CALCULATIENR: | TEKENINGNR: 9163N | MODEL: | HOUTSOORT: |
|--------|------------|---------------|----------------------|--------|------------|

| | | | | |
|--|----------------------------------------------------|--|--|-------------|
| | KLANT/PROJECT: overzicht modellen 9163N L1 - R4 | | | DCM NUMMER: |
|--|----------------------------------------------------|--|--|-------------|

| | | | | |
|-----------|---------|-----------------|------------|-----------|
| AANVRAAG: | SCHAAL: | GETEKEND: MN | LEVERWEEK: | 1.2a P.10 |
|-----------|---------|-----------------|------------|-----------|

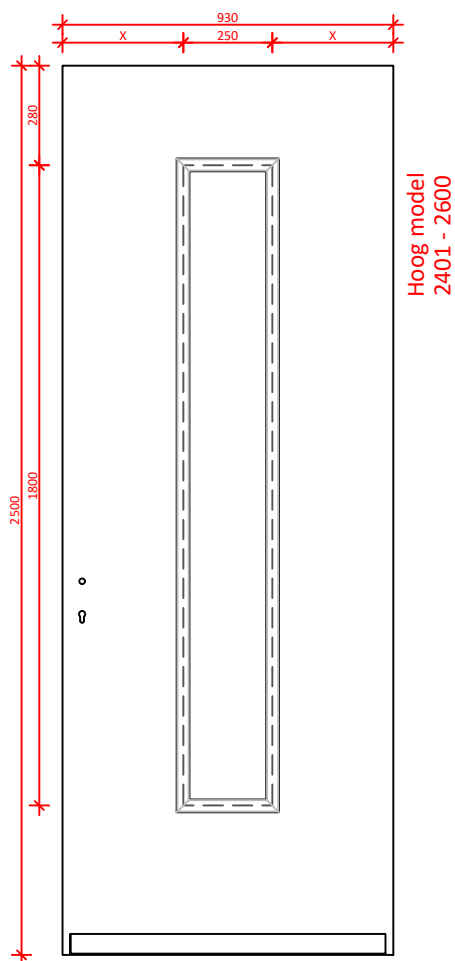
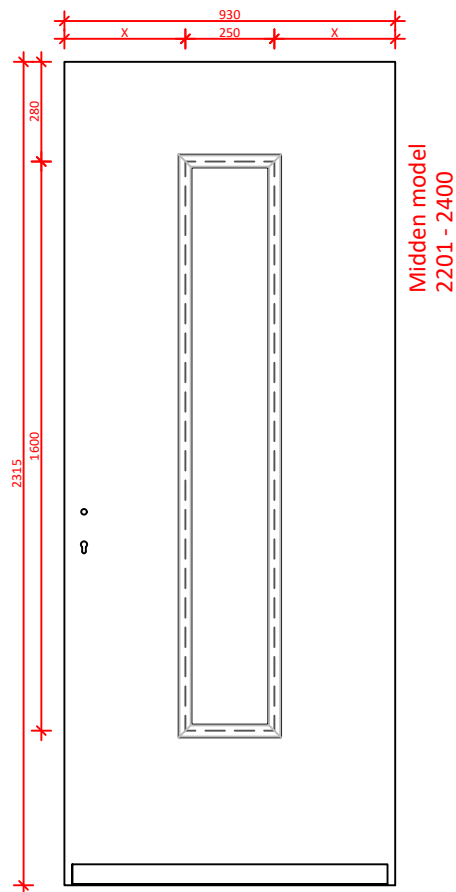
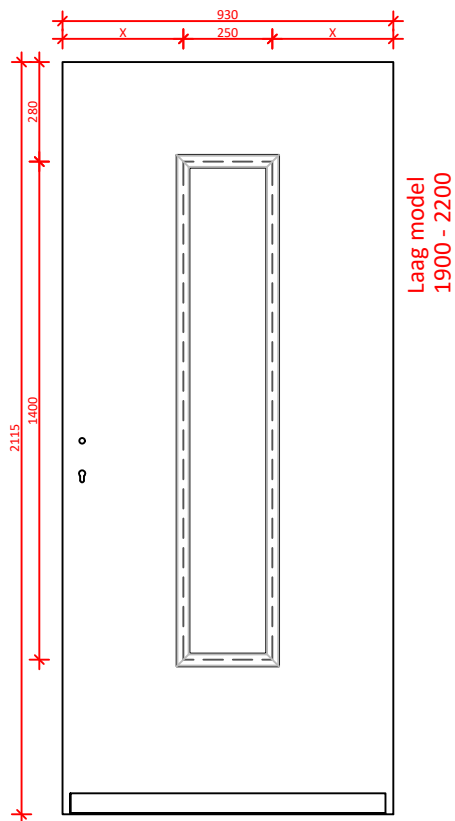

| | | | | | |
|--------|------------|---------------|----------------------|--------|------------|
| DATUM: | GEWIJZIGD: | CALCULATIENR: | TEKENINGNR: 9165N | MODEL: | HOUTSOORT: |
|--------|------------|---------------|----------------------|--------|------------|

| | | | | |
|-----------------------|--------------------------------------------|--|--|-------------|
| KEGRO DEUREN | KLANT/PROJECT: overzicht modellen 9165N | | | DCM NUMMER: |
|-----------------------|--------------------------------------------|--|--|-------------|

| | | | | |
|-----------|---------|-----------------|------------|-----------|
| AANVRAAG: | SCHAAL: | GETEKEND: MN | LEVERWEEK: | 1.2a P.11 |
|-----------|---------|-----------------|------------|-----------|

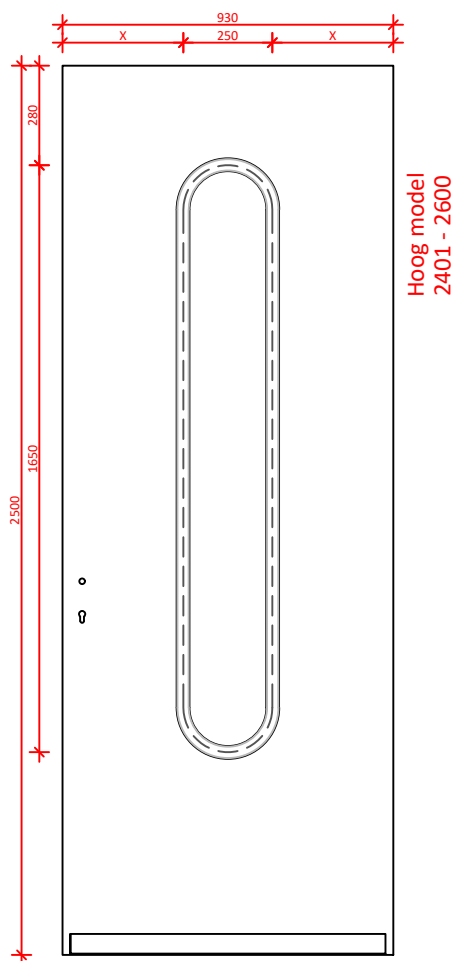
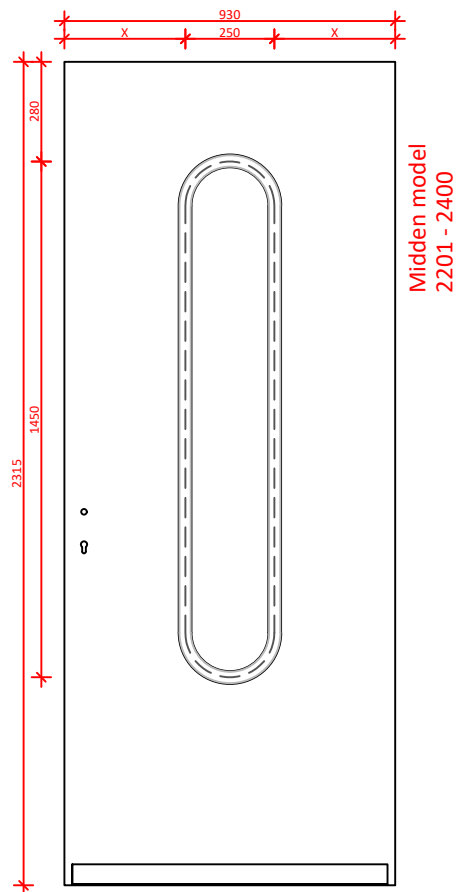
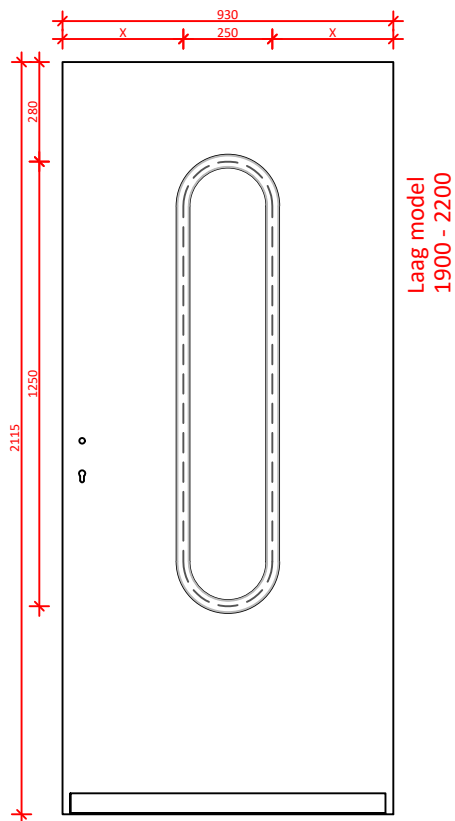

| | | | | | |
|--------|------------|---------------|----------------------|--------|------------|
| DATUM: | GEWIJZIGD: | CALCULATIENR: | TEKENINGNR: 9166N | MODEL: | HOUTSOORT: |
|--------|------------|---------------|----------------------|--------|------------|

| | | | | |
|--|--------------------------------------------|--|--|-------------|
| | KLANT/PROJECT: overzicht modellen 9166N | | | DCM NUMMER: |
|--|--------------------------------------------|--|--|-------------|

| | | | | |
|-----------|---------|-----------------|------------|-----------|
| AANVRAAG: | SCHAAL: | GETEKEND: MN | LEVERWEEK: | 1.2a P.12 |
|-----------|---------|-----------------|------------|-----------|

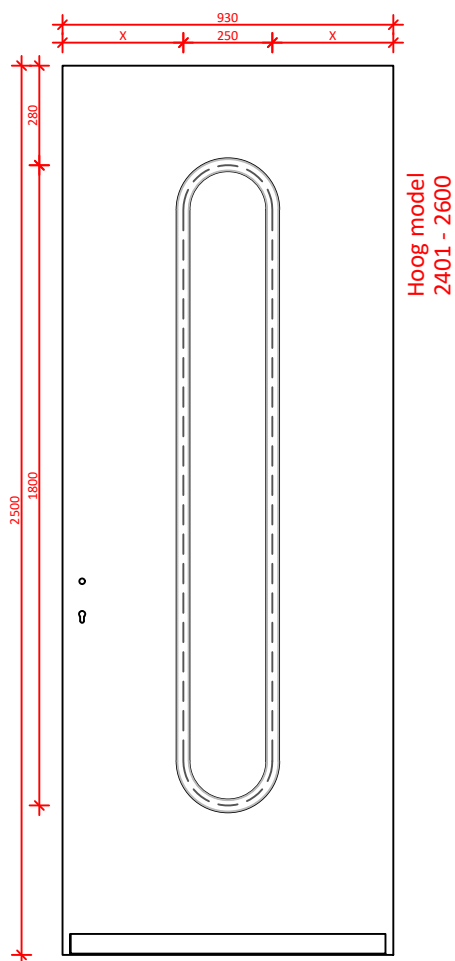
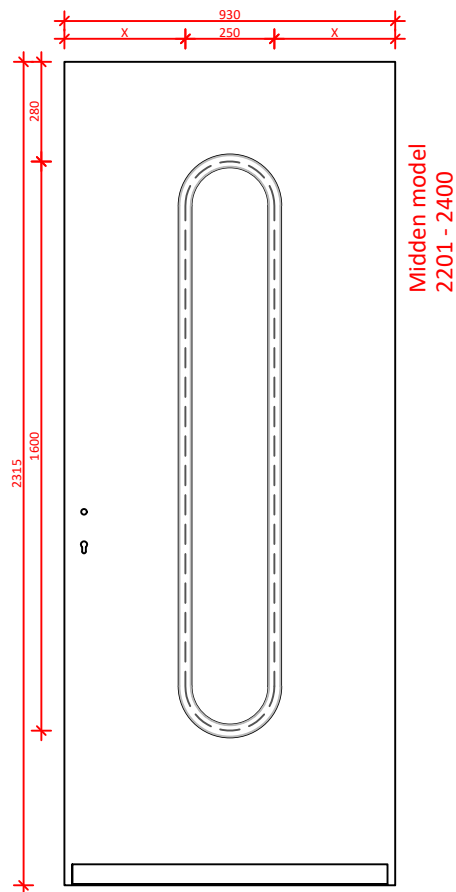
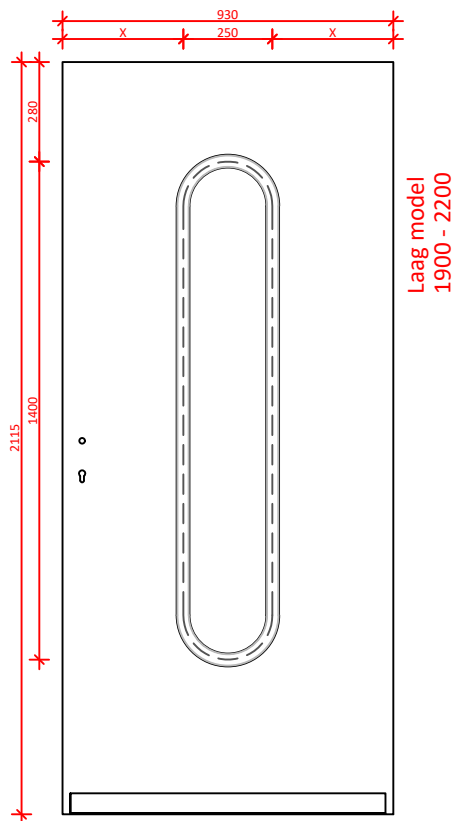

| | | | | | |
|--------|------------|---------------|----------------------|--------|------------|
| DATUM: | GEWIJZIGD: | CALCULATIENR: | TEKENINGNR: 9167N | MODEL: | HOUTSOORT: |
|--------|------------|---------------|----------------------|--------|------------|

| | | | | |
|-----------------------|--------------------------------------------|--|--|-------------|
| KEGRO DEUREN | KLANT/PROJECT: overzicht modellen 9167N | | | DCM NUMMER: |
|-----------------------|--------------------------------------------|--|--|-------------|

| | | | | |
|-----------|---------|-----------------|------------|-----------|
| AANVRAAG: | SCHAAL: | GETEKEND: MN | LEVERWEEK: | 1.2a P.13 |
|-----------|---------|-----------------|------------|-----------|

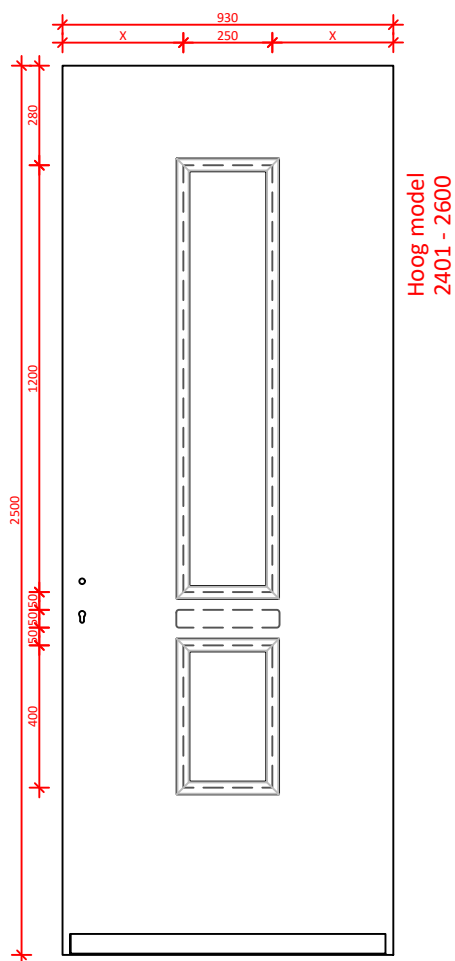
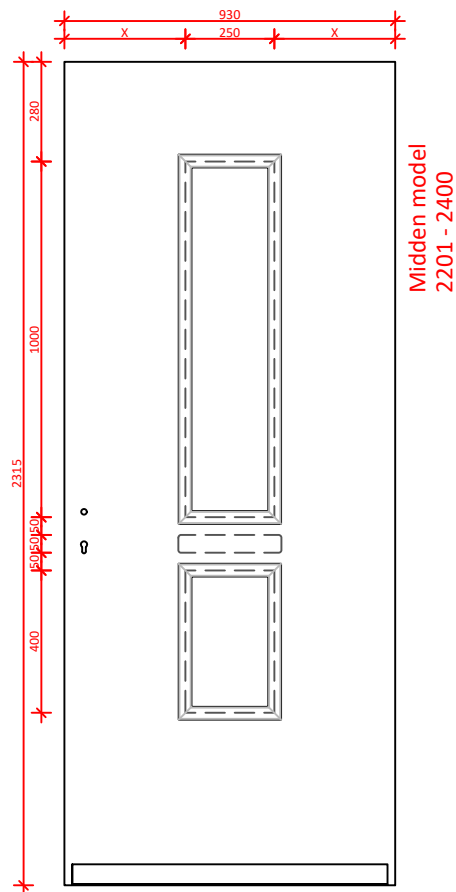
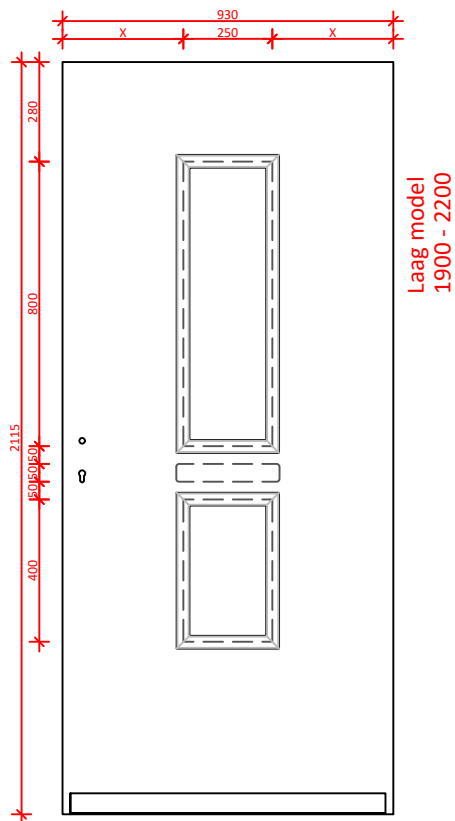

| | | | | | |
|--------|------------|---------------|----------------------|--------|------------|
| DATUM: | GEWIJZIGD: | CALCULATIENR: | TEKENINGNR: 9168N | MODEL: | HOUTSOORT: |
|--------|------------|---------------|----------------------|--------|------------|

| | | | | |
|--|--------------------------------------------|--|--|-------------|
| | KLANT/PROJECT: overzicht modellen 9168N | | | DCM NUMMER: |
|--|--------------------------------------------|--|--|-------------|

| | | | | |
|-----------|---------|-----------------|------------|-----------|
| AANVRAAG: | SCHAAL: | GETEKEND: MN | LEVERWEEK: | 1.2a P.14 |
|-----------|---------|-----------------|------------|-----------|

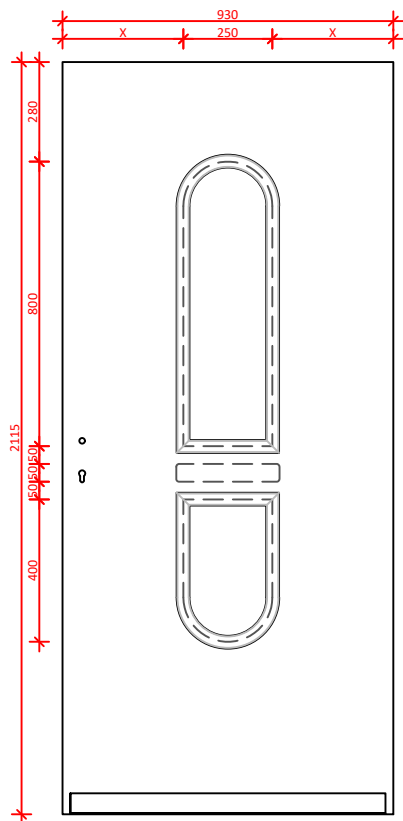

Laag model
1900 - 2200

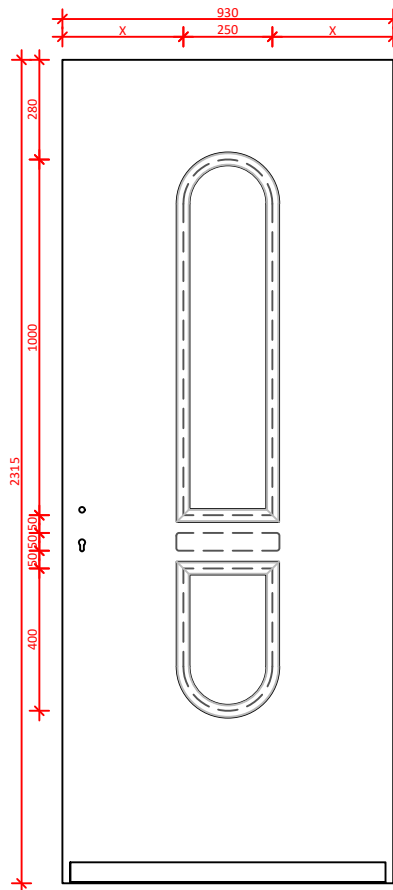

Midden model
2201 - 2400

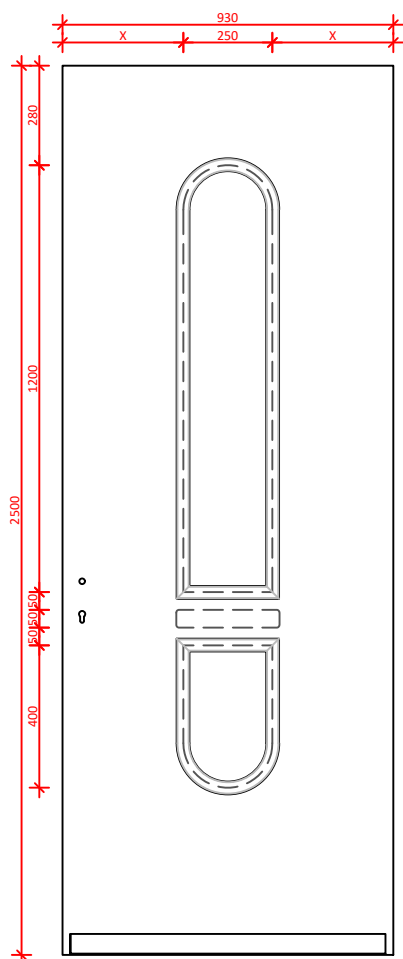

Hoog model
2401 - 2600

| | | | | | |
|--------|------------|---------------|----------------------|--------|------------|
| DATUM: | GEWIJZIGD: | CALCULATIENR: | TEKENINGNR: 9169N | MODEL: | HOUTSOORT: |
|--------|------------|---------------|----------------------|--------|------------|

| | | | | |
|------------------------------------------------------------------------------------|--------------------------------------------|--|--|-------------|
|  | KLANT/PROJECT: overzicht modellen 9169N | | | DCM NUMMER: |
|------------------------------------------------------------------------------------|--------------------------------------------|--|--|-------------|

| | | | | |
|-----------|---------|-----------------|------------|-----------|
| AANVRAAG: | SCHAAL: | GETEKEND: MN | LEVERWEEK: | 1.2a P.15 |
|-----------|---------|-----------------|------------|-----------|

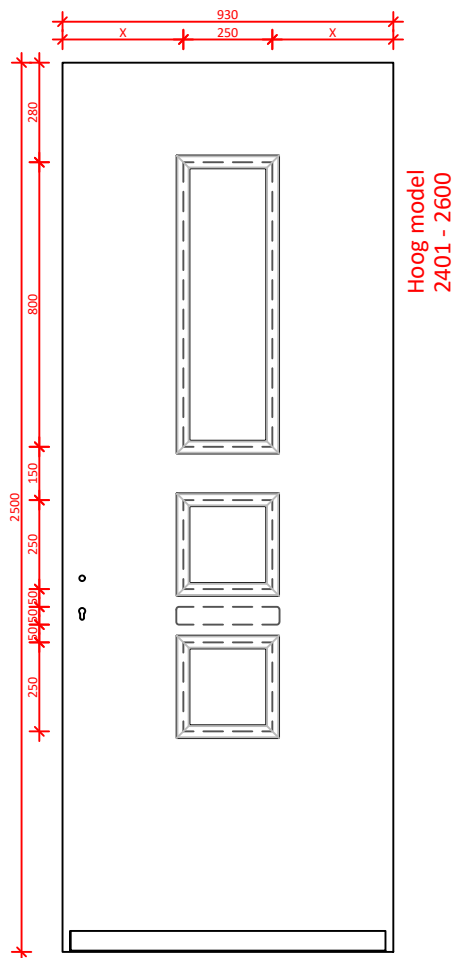
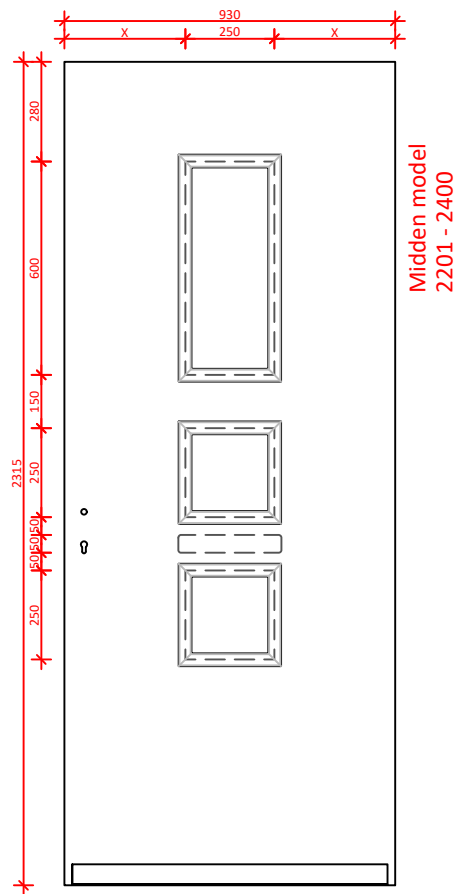
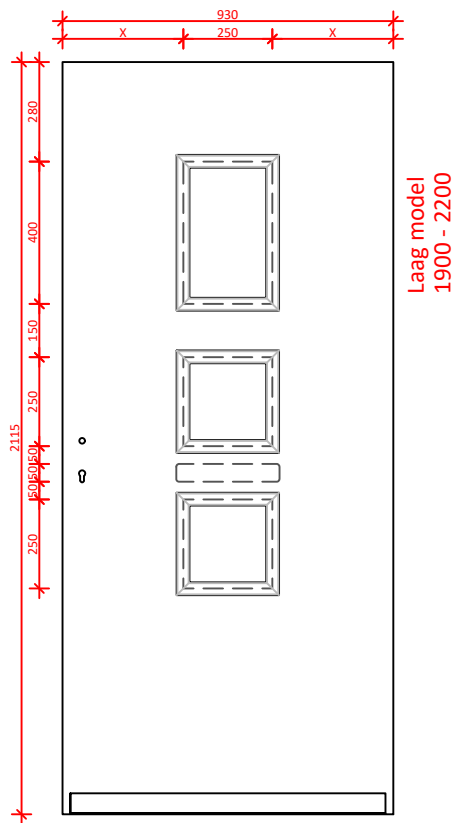

| | | | | | |
|--------|------------|---------------|-------------|-----------------|------------|
| DATUM: | GEWIJZIGD: | CALCULATIENR: | TEKENINGNR: | MODEL: 9170N | HOUTSOORT: |
|--------|------------|---------------|-------------|-----------------|------------|

| | | | | |
|-----------------------|--------------------------------------------|--|--|-------------|
| KEGRO DEUREN | KLANT/PROJECT: overzicht modellen 9170N | | | DCM NUMMER: |
|-----------------------|--------------------------------------------|--|--|-------------|

| | | | |
|-----------|---------|-----------------|-------------------------|
| AANVRAAG: | SCHAAL: | GETEKEND: MN | LEVERWEEK: 1.2a P.16 |
|-----------|---------|-----------------|-------------------------|

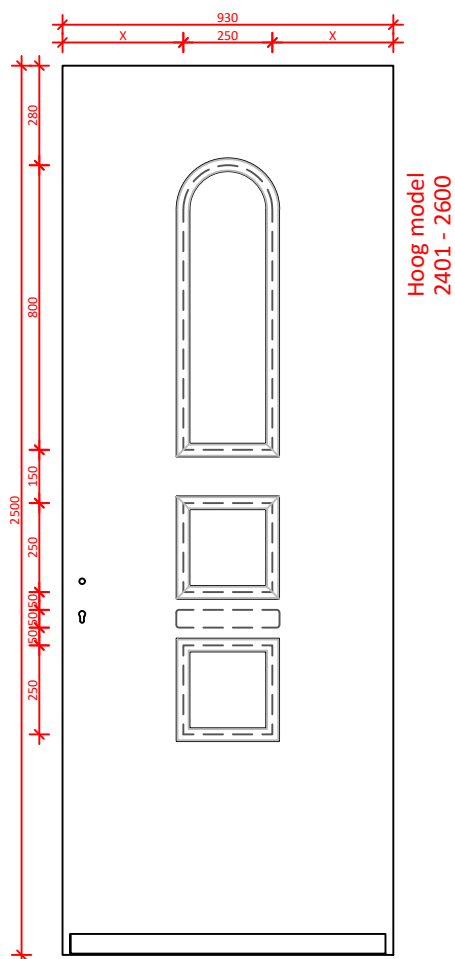
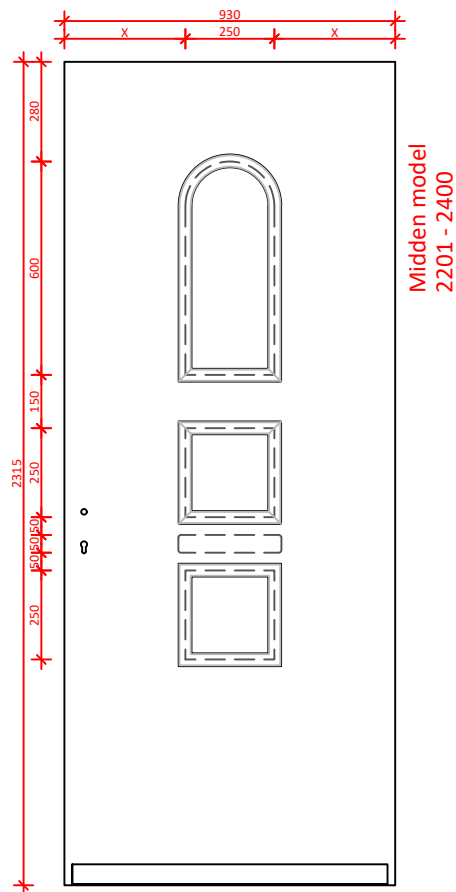
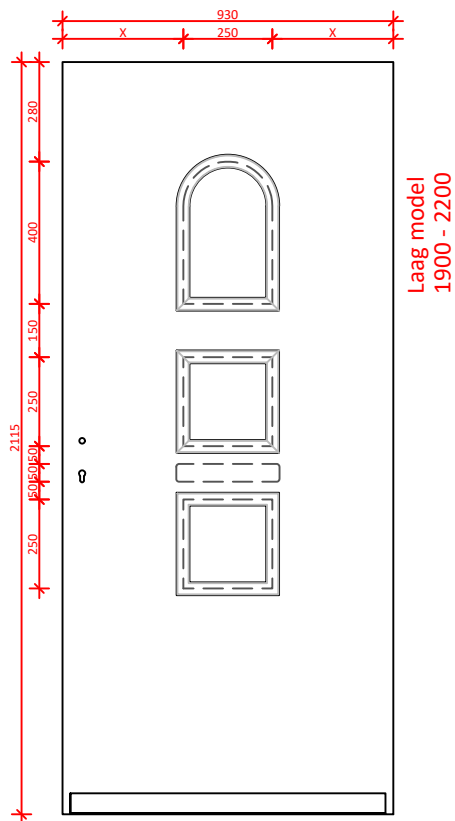

| | | | | | |
|--------|------------|---------------|-------------|-----------------|------------|
| DATUM: | GEWIJZIGD: | CALCULATIENR: | TEKENINGNR: | MODEL: 9171N | HOUTSOORT: |
|--------|------------|---------------|-------------|-----------------|------------|

| | | | | |
|--|--------------------------------------------|--|--|-------------|
| | KLANT/PROJECT: overzicht modellen 9171N | | | DCM NUMMER: |
|--|--------------------------------------------|--|--|-------------|

| | | | |
|-----------|---------|-----------------|-------------------------|
| AANVRAAG: | SCHAAL: | GETEKEND: MN | LEVERWEEK: 1.2a P.17 |
|-----------|---------|-----------------|-------------------------|

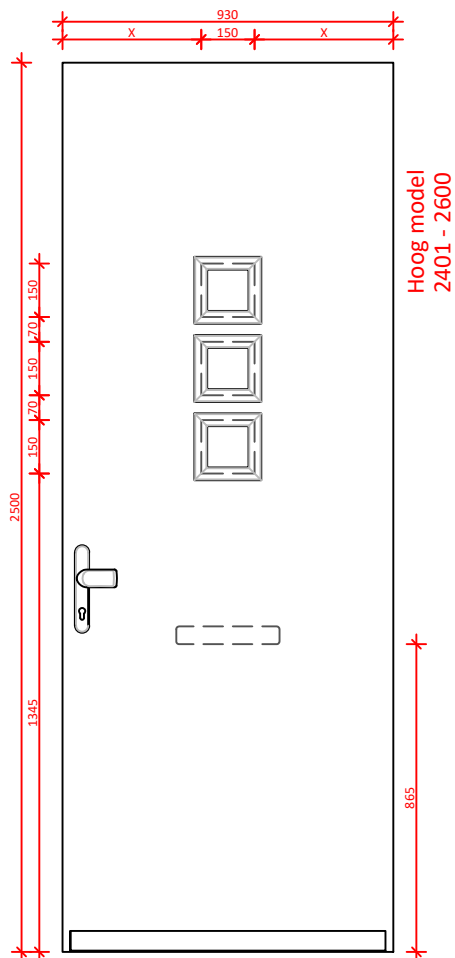
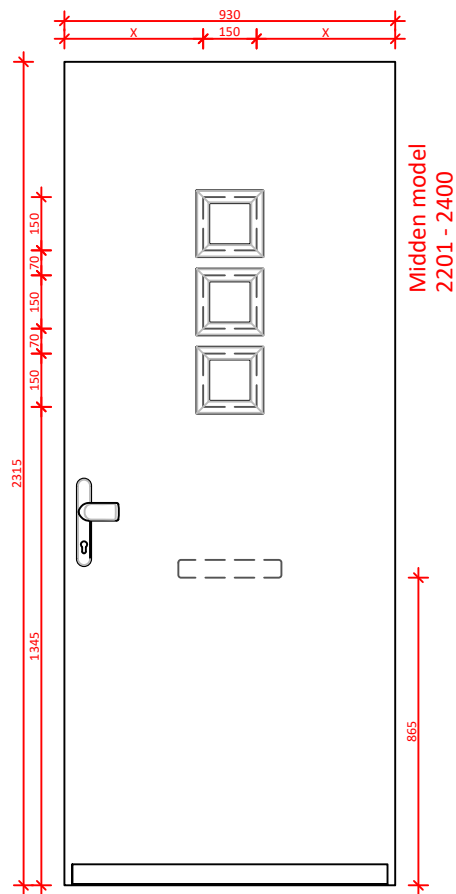
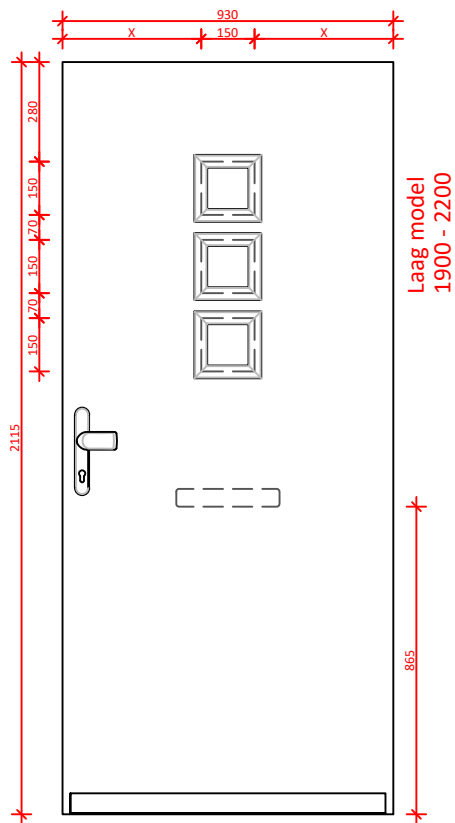

| | | | | | |
|--------|------------|---------------|-------------|-----------------|------------|
| DATUM: | GEWIJZIGD: | CALCULATIENR: | TEKENINGNR: | MODEL: 9172N | HOUTSOORT: |
|--------|------------|---------------|-------------|-----------------|------------|

| | | | | |
|--|--------------------------------------------|--|--|-------------|
| | KLANT/PROJECT: overzicht modellen 9172N | | | DCM NUMMER: |
|--|--------------------------------------------|--|--|-------------|

| | | | |
|-----------|---------|-----------------|-------------------------|
| AANVRAAG: | SCHAAL: | GETEKEND: MN | LEVERWEEK: 1.2a P.18 |
|-----------|---------|-----------------|-------------------------|

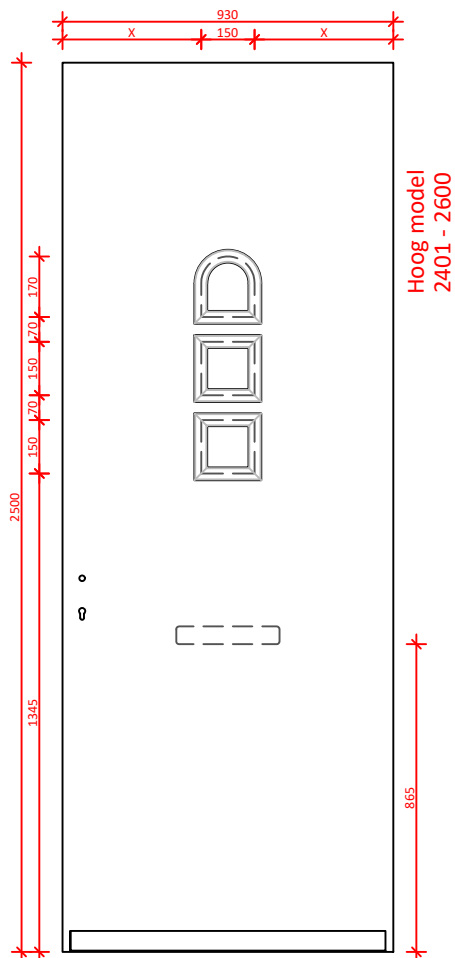
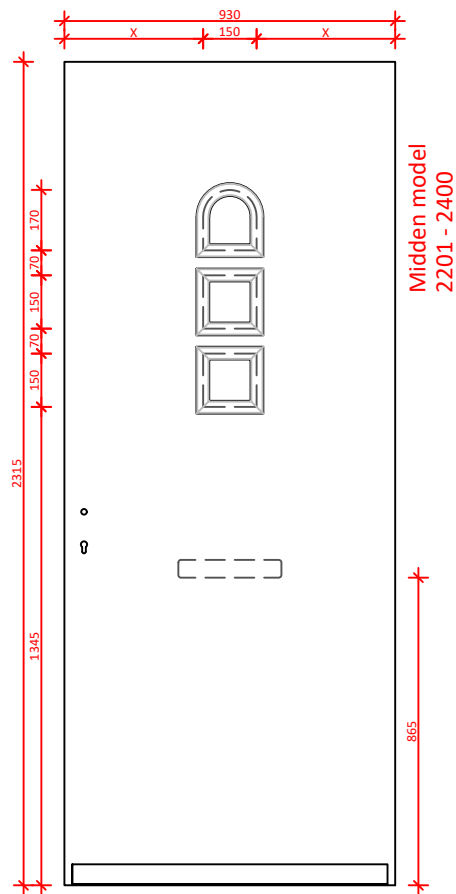
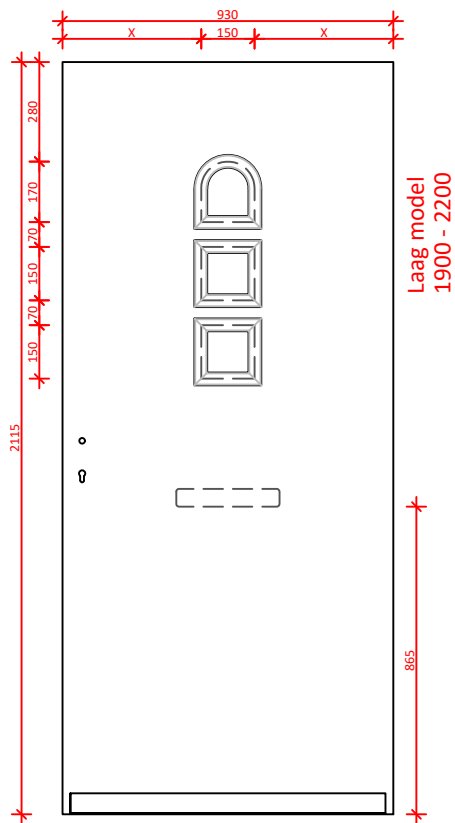

| | | | | | |
|--------|------------|---------------|-------------|-----------------|------------|
| DATUM: | GEWIJZIGD: | CALCULATIENR: | TEKENINGNR: | MODEL: 9173N | HOUTSOORT: |
|--------|------------|---------------|-------------|-----------------|------------|

| | | | | |
|--|--------------------------------------------|--|--|-------------|
| | KLANT/PROJECT: overzicht modellen 9173N | | | DCM NUMMER: |
|--|--------------------------------------------|--|--|-------------|

| | | | | |
|-----------|---------|-----------------|------------|-----------|
| AANVRAAG: | SCHAAL: | GETEKEND: MN | LEVERWEEK: | 1.2a P.19 |
|-----------|---------|-----------------|------------|-----------|

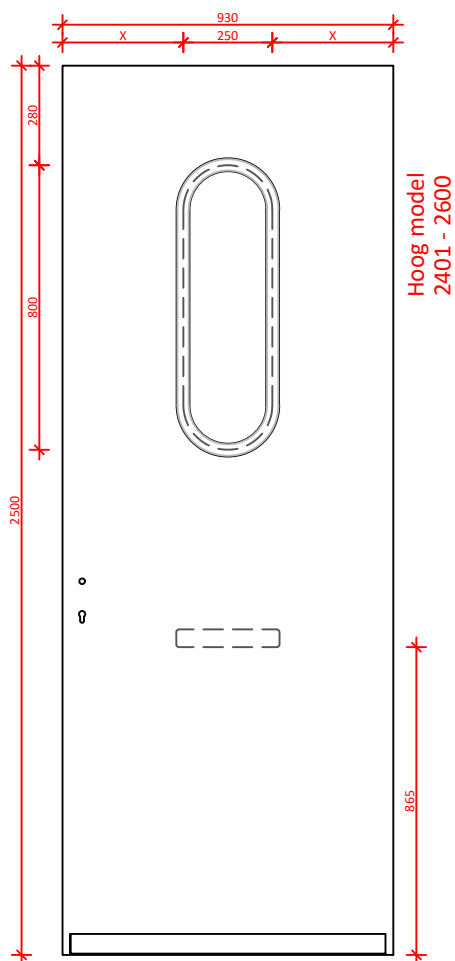
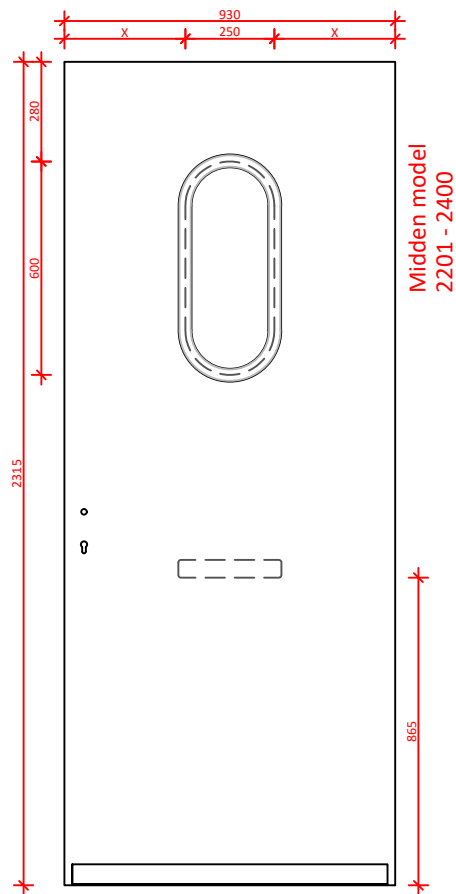
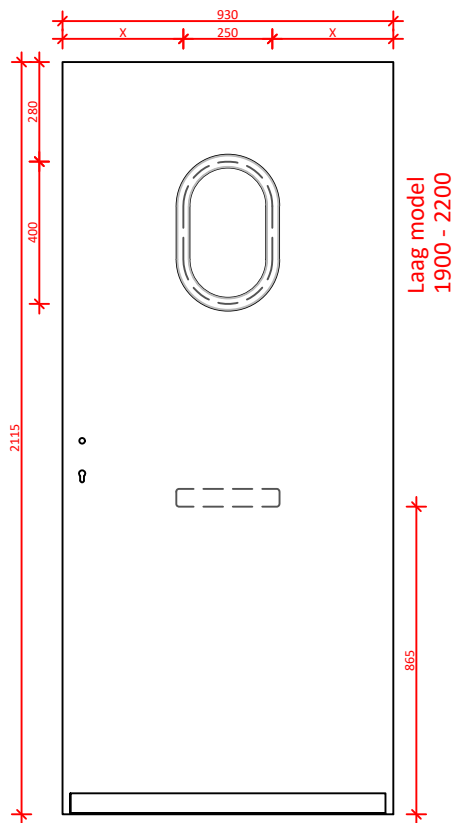

| | | | | | |
|--------|------------|---------------|-------------|-----------------|------------|
| DATUM: | GEWIJZIGD: | CALCULATIENR: | TEKENINGNR: | MODEL: 9174N | HOUTSOORT: |
|--------|------------|---------------|-------------|-----------------|------------|

| | | | | |
|--|--------------------------------------------|--|--|-------------|
| | KLANT/PROJECT: overzicht modellen 9174N | | | DCM NUMMER: |
|--|--------------------------------------------|--|--|-------------|

| | | | | |
|-----------|---------|-----------------|------------|-----------|
| AANVRAAG: | SCHAAL: | GETEKEND: MN | LEVERWEEK: | 1.2a P.20 |
|-----------|---------|-----------------|------------|-----------|

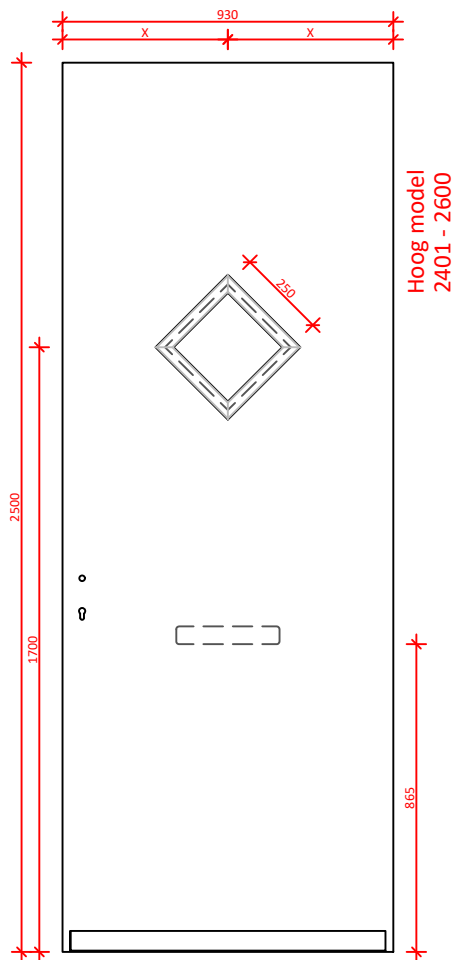
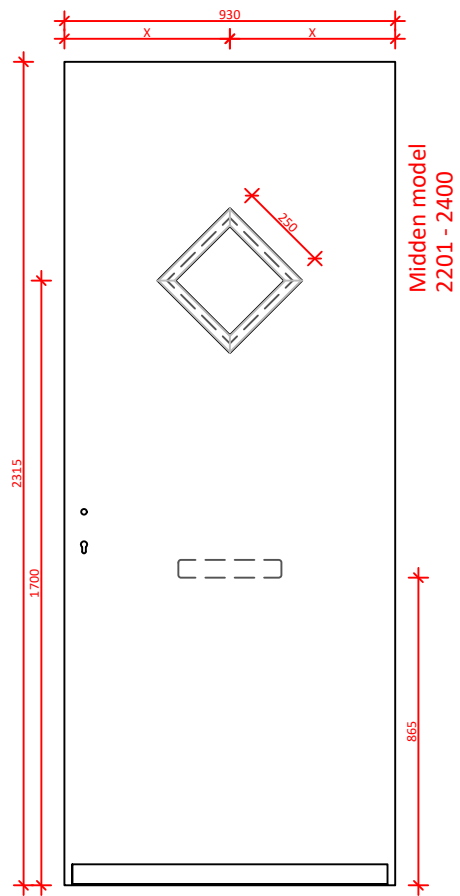
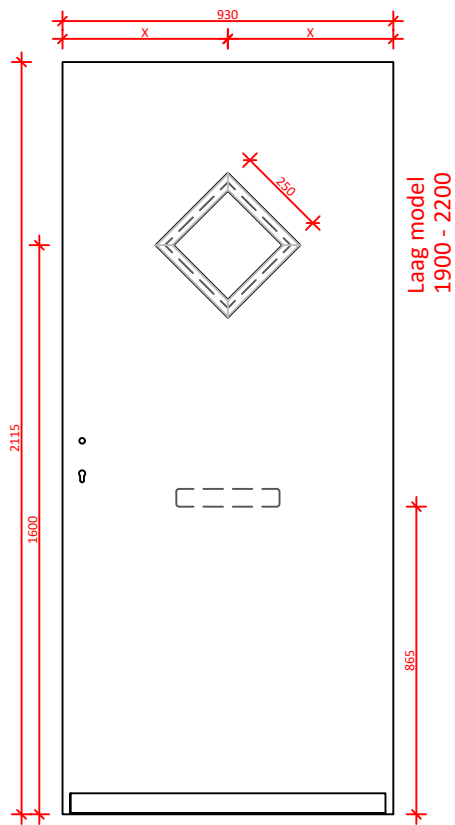

| | | | | | |
|--------|------------|---------------|-------------|-----------------|------------|
| DATUM: | GEWIJZIGD: | CALCULATIENR: | TEKENINGNR: | MODEL: 9175N | HOUTSOORT: |
|--------|------------|---------------|-------------|-----------------|------------|

| | | | | |
|--|--------------------------------------------|--|--|-------------|
| | KLANT/PROJECT: overzicht modellen 9175N | | | DCM NUMMER: |
|--|--------------------------------------------|--|--|-------------|

| | | | | |
|-----------|---------|-----------------|------------|-----------|
| AANVRAAG: | SCHAAL: | GETEKEND: MN | LEVERWEEK: | 1.2a P.21 |
|-----------|---------|-----------------|------------|-----------|

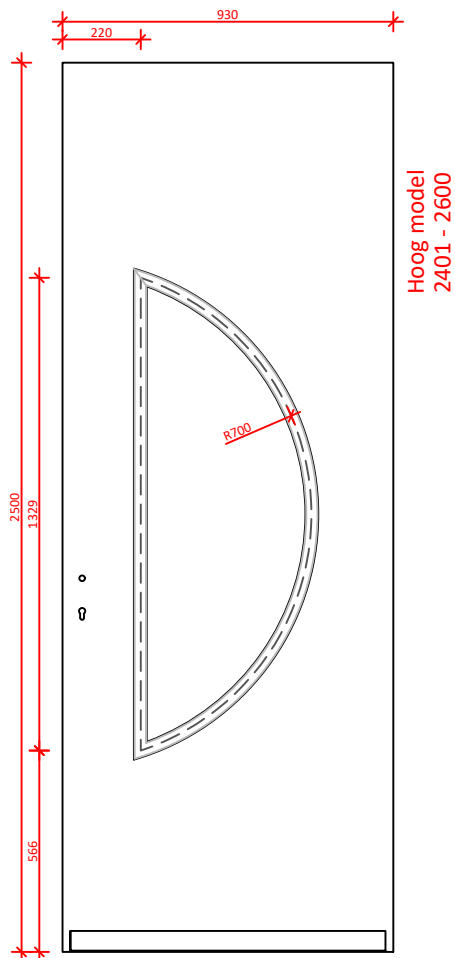
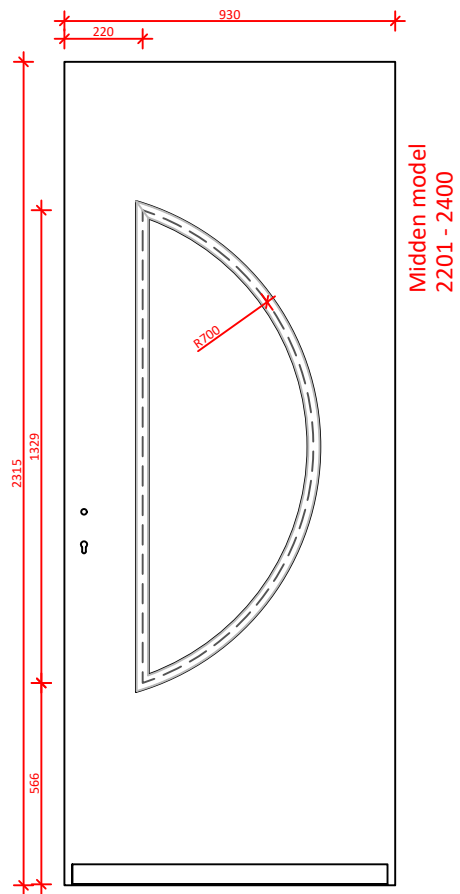
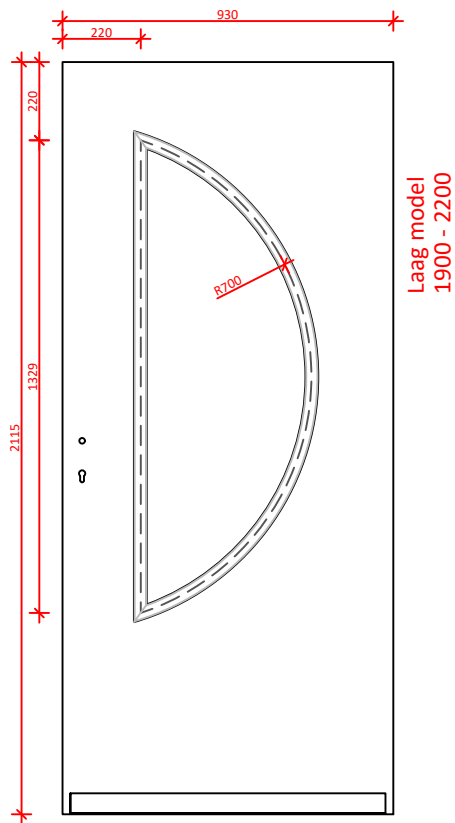

| | | | | | |
|--------|------------|---------------|-------------|-----------------|------------|
| DATUM: | GEWIJZIGD: | CALCULATIENR: | TEKENINGNR: | MODEL: 9176N | HOUTSOORT: |
|--------|------------|---------------|-------------|-----------------|------------|

| | | | | |
|--|----------------------------------------------------|--|--|-------------|
| | KLANT/PROJECT: overzicht modellen 9176N L1 - R4 | | | DCM NUMMER: |
|--|----------------------------------------------------|--|--|-------------|

| | | | |
|-----------|---------|-----------------|-------------------------|
| AANVRAAG: | SCHAAL: | GETEKEND: MN | LEVERWEEK: 1.2a P.22 |
|-----------|---------|-----------------|-------------------------|

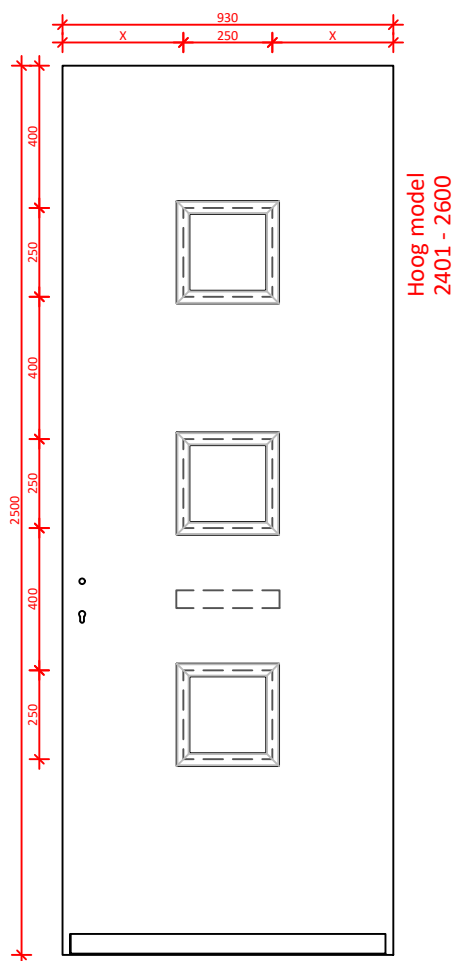
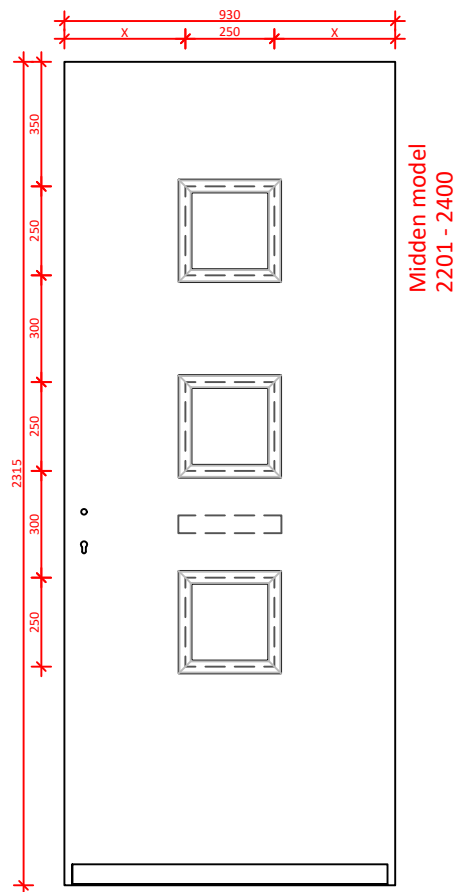
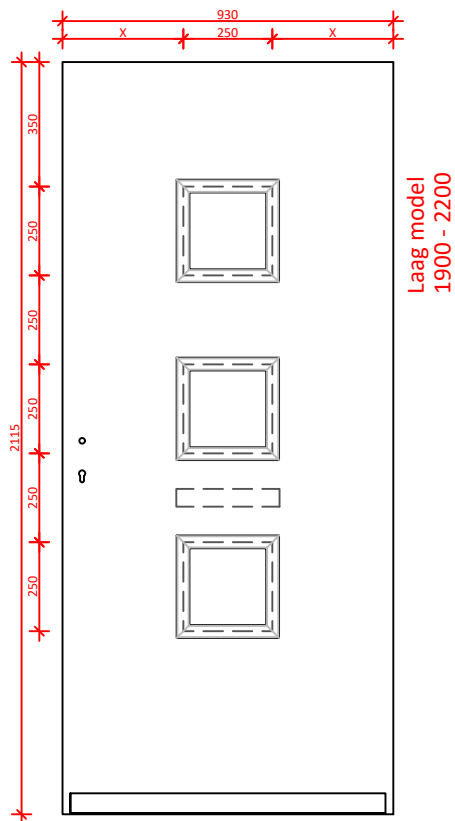

| | | | | | |
|--------|------------|---------------|-------------|-----------------|------------|
| DATUM: | GEWIJZIGD: | CALCULATIENR: | TEKENINGNR: | MODEL: 9178N | HOUTSOORT: |
|--------|------------|---------------|-------------|-----------------|------------|

| | | | | |
|-----------------------|--------------------------------------------|--|--|-------------|
| KEGRO DEUREN | KLANT/PROJECT: overzicht modellen 9178N | | | DCM NUMMER: |
|-----------------------|--------------------------------------------|--|--|-------------|

| | | | | |
|-----------|---------|-----------------|------------|-----------|
| AANVRAAG: | SCHAAL: | GETEKEND: MN | LEVERWEEK: | 1.2a P.23 |
|-----------|---------|-----------------|------------|-----------|

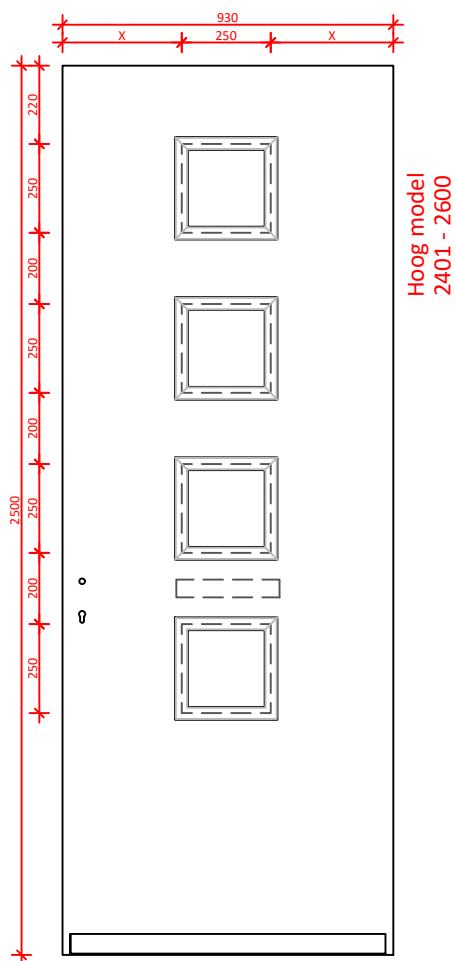
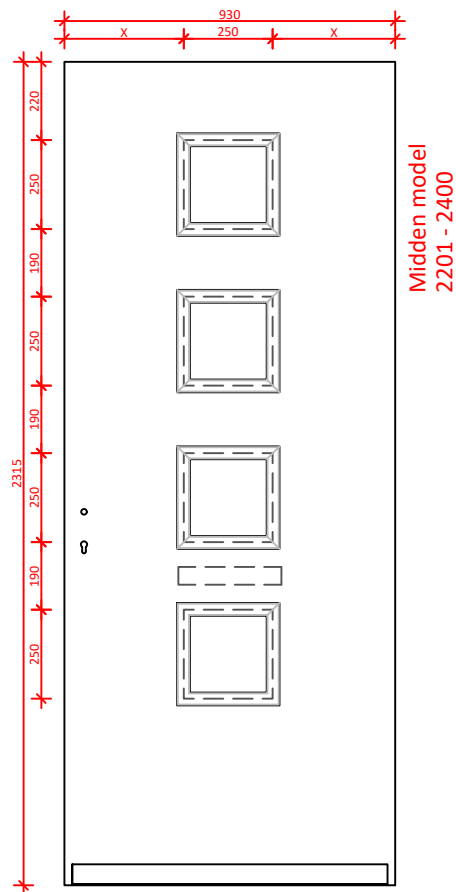
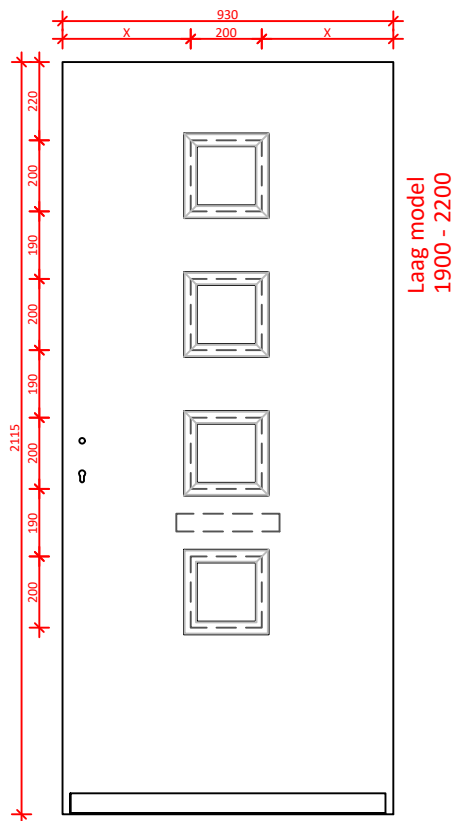

| | | | | | |
|--------|------------|---------------|-------------|-----------------|------------|
| DATUM: | GEWIJZIGD: | CALCULATIENR: | TEKENINGNR: | MODEL: 9179N | HOUTSOORT: |
|--------|------------|---------------|-------------|-----------------|------------|

| | | | | |
|--|--------------------------------------------|--|--|-------------|
| | KLANT/PROJECT: overzicht modellen 9179N | | | DCM NUMMER: |
|--|--------------------------------------------|--|--|-------------|

| | | | |
|-----------|---------|-----------------|-------------------------|
| AANVRAAG: | SCHAAL: | GETEKEND: MN | LEVERWEEK: 1.2a P.24 |
|-----------|---------|-----------------|-------------------------|

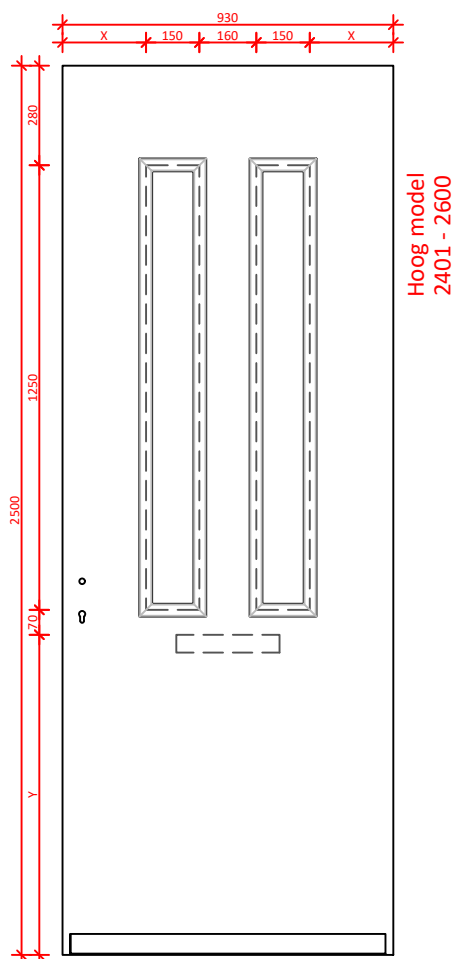
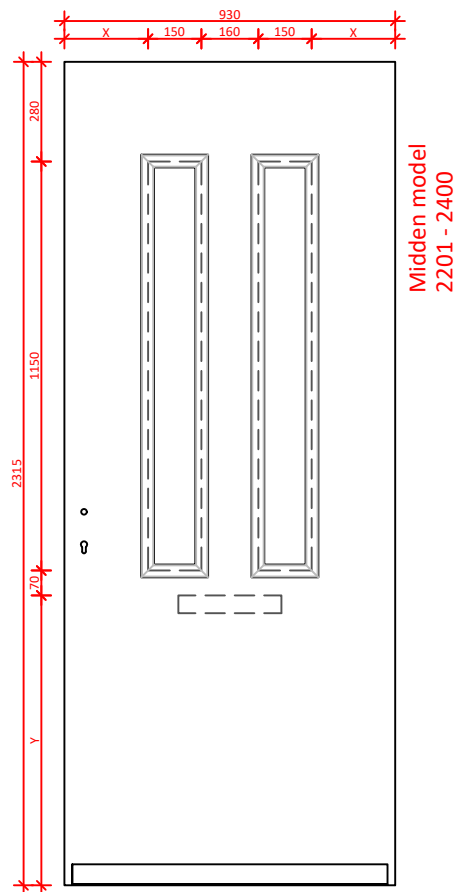
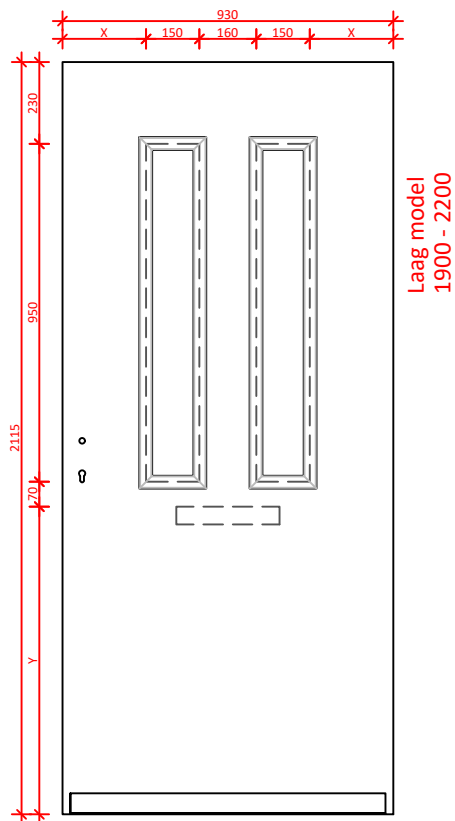

| | | | | | |
|--------|------------|---------------|-------------|-----------------|------------|
| DATUM: | GEWIJZIGD: | CALCULATIENR: | TEKENINGNR: | MODEL: 9180N | HOUTSOORT: |
|--------|------------|---------------|-------------|-----------------|------------|

| | | | | |
|------------------------------------------------------------------------------------|--------------------------------------------|--|--|-------------|
|  | KLANT/PROJECT: overzicht modellen 9180N | | | DCM NUMMER: |
|------------------------------------------------------------------------------------|--------------------------------------------|--|--|-------------|

| | | | |
|-----------|---------|-----------------|-------------------------|
| AANVRAAG: | SCHAAL: | GETEKEND: MN | LEVERWEEK: 1.2a P.25 |
|-----------|---------|-----------------|-------------------------|

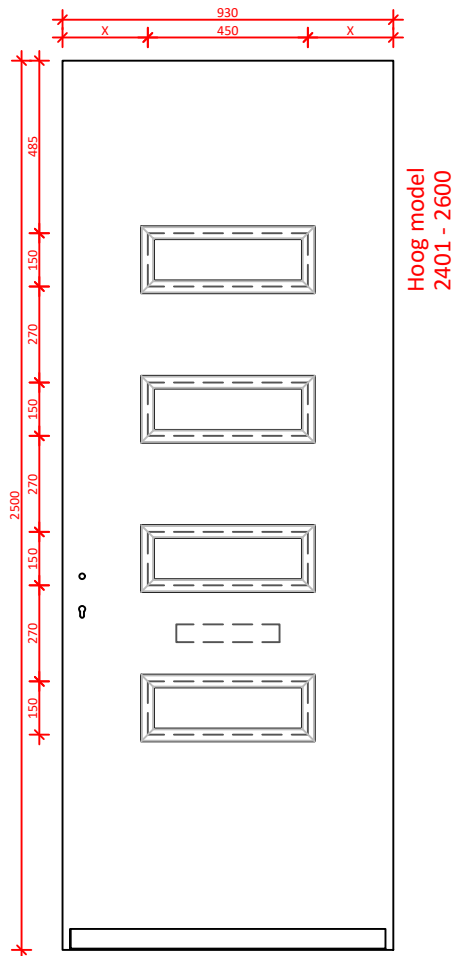
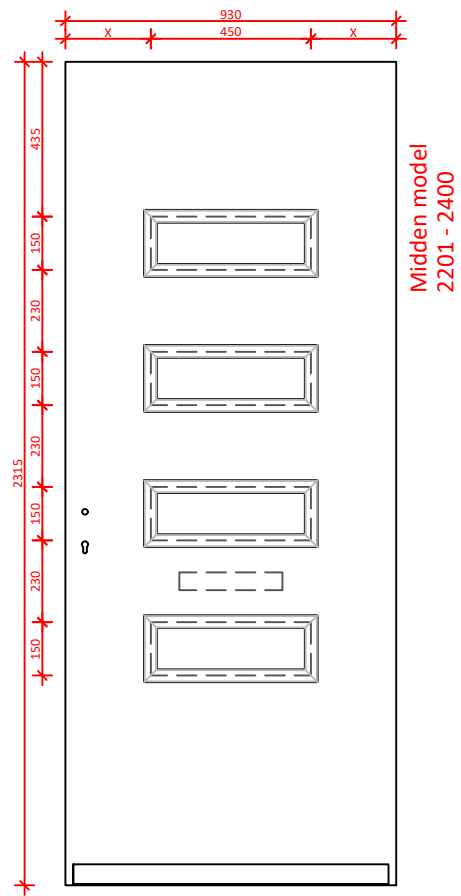
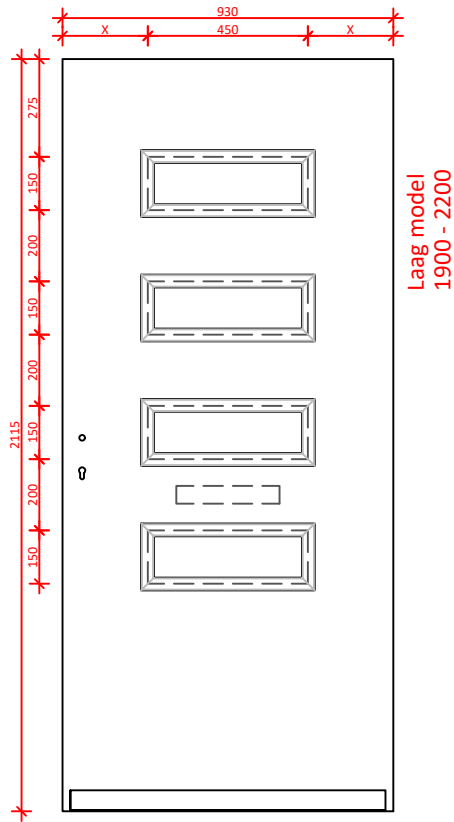

Strakke SponningMaat van de glasopening:
 Pasmaat deurbreedte t/m 1000 mm : SSM 450mm
 Pasmaat deurbreedte 1001 t/m 1100 mm : SSM 550mm
 Pasmaat deurbreedte > 1101 mm : SSM 650mm

| | | | | | |
|--------|------------|---------------|-------------|-----------------|------------|
| DATUM: | GEWIJZIGD: | CALCULATIENR: | TEKENINGNR: | MODEL: 9181N | HOUTSOORT: |
|--------|------------|---------------|-------------|-----------------|------------|

| | | | | |
|--|--------------------------------------------|--|--|-------------|
| | KLANT/PROJECT: overzicht modellen 9181N | | | DCM NUMMER: |
|--|--------------------------------------------|--|--|-------------|

| | | | |
|-----------|---------|-----------------|-------------------------|
| AANVRAAG: | SCHAAL: | GETEKEND: MN | LEVERWEEK: 1.2a P.26 |
|-----------|---------|-----------------|-------------------------|

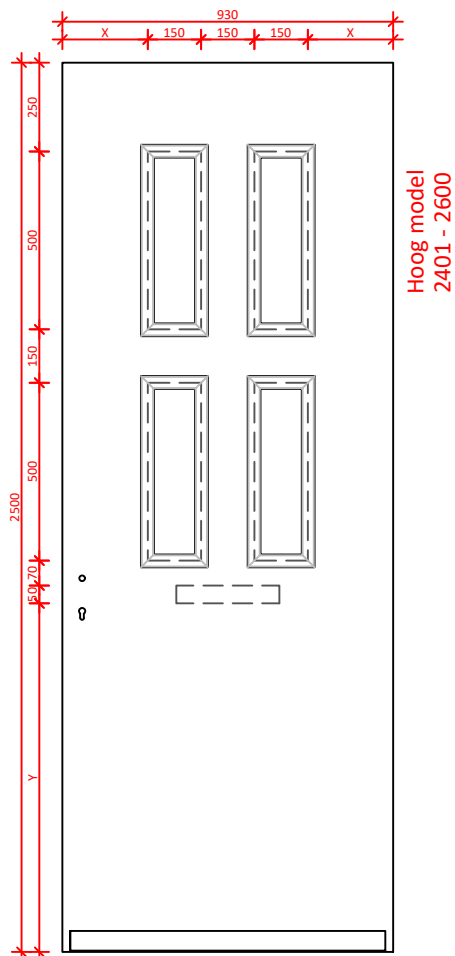
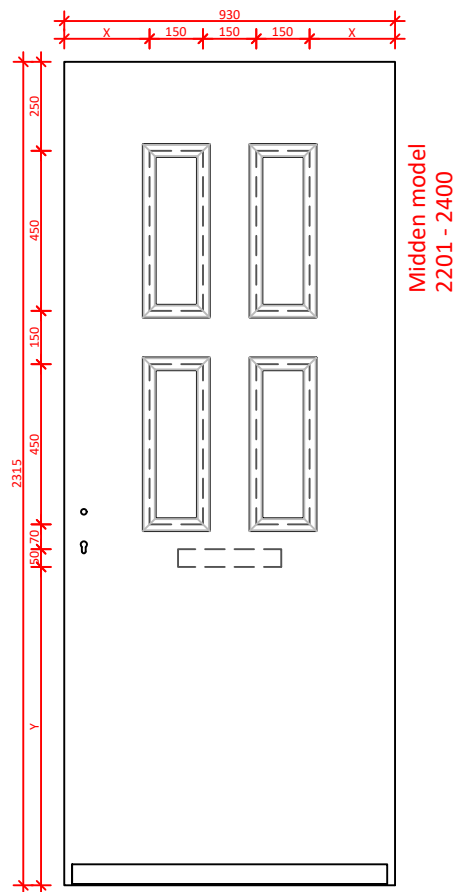
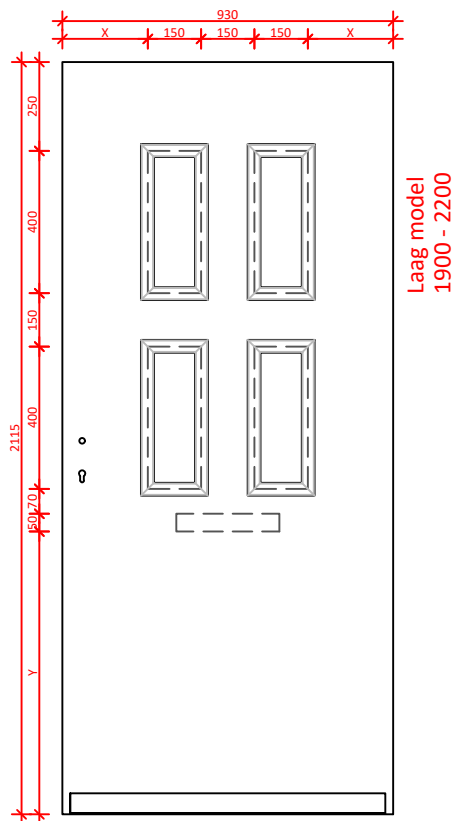

| | | | | | |
|--------|------------|---------------|-------------|-----------------|------------|
| DATUM: | GEWIJZIGD: | CALCULATIENR: | TEKENINGNR: | MODEL: 9182N | HOUTSOORT: |
|--------|------------|---------------|-------------|-----------------|------------|

| | | | | |
|--|--------------------------------------------|--|--|-------------|
| | KLANT/PROJECT: overzicht modellen 9182N | | | DCM NUMMER: |
|--|--------------------------------------------|--|--|-------------|

| | | | |
|-----------|---------|-----------------|-------------------------|
| AANVRAAG: | SCHAAL: | GETEKEND: MN | LEVERWEEK: 1.2a P.27 |
|-----------|---------|-----------------|-------------------------|

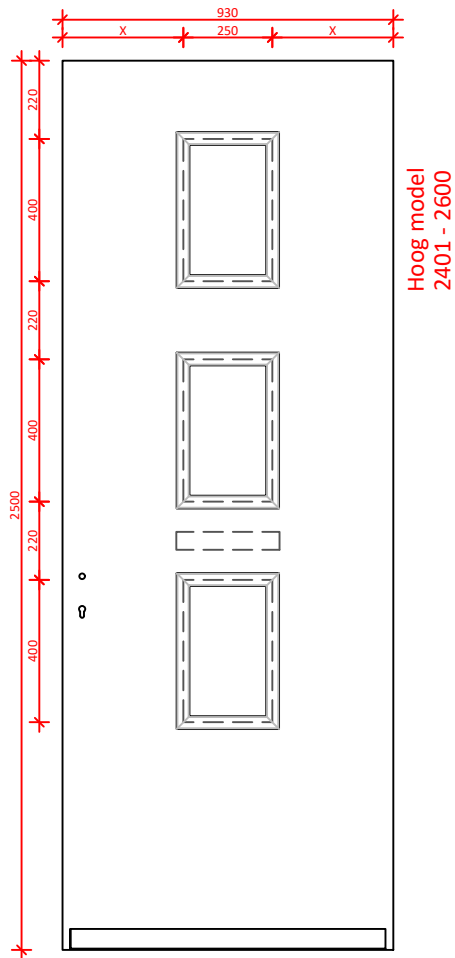
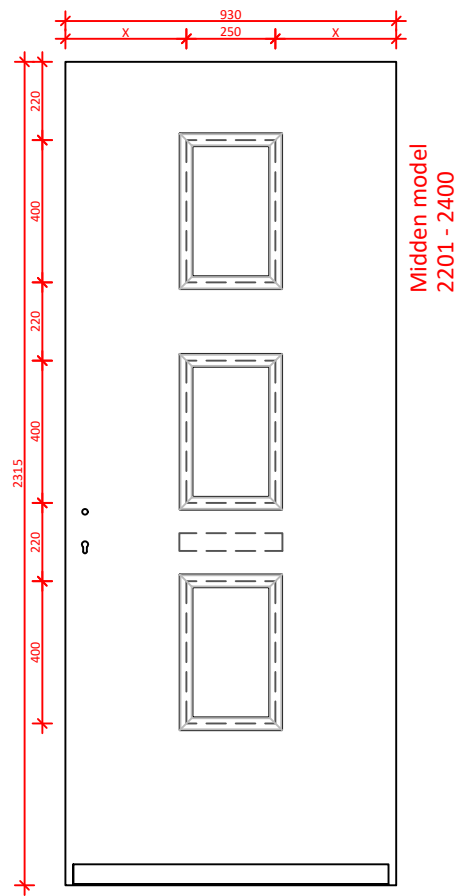
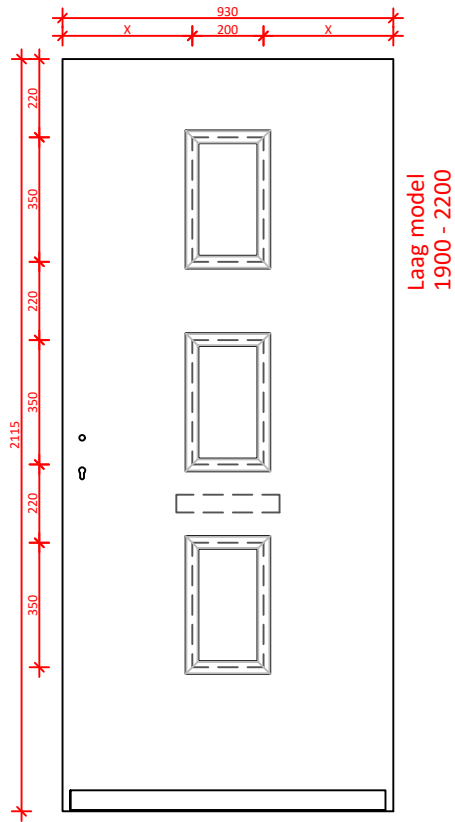

| | | | | | |
|--------|------------|---------------|-------------|-----------------|------------|
| DATUM: | GEWIJZIGD: | CALCULATIENR: | TEKENINGNR: | MODEL: 9183N | HOUTSOORT: |
|--------|------------|---------------|-------------|-----------------|------------|

| | | | | |
|------------------------------------------------------------------------------------|--------------------------------------------|--|--|-------------|
|  | KLANT/PROJECT: overzicht modellen 9183N | | | DCM NUMMER: |
|------------------------------------------------------------------------------------|--------------------------------------------|--|--|-------------|

| | | | | |
|-----------|---------|-----------------|------------|-----------|
| AANVRAAG: | SCHAAL: | GETEKEND: MN | LEVERWEEK: | 1.2a P.28 |
|-----------|---------|-----------------|------------|-----------|

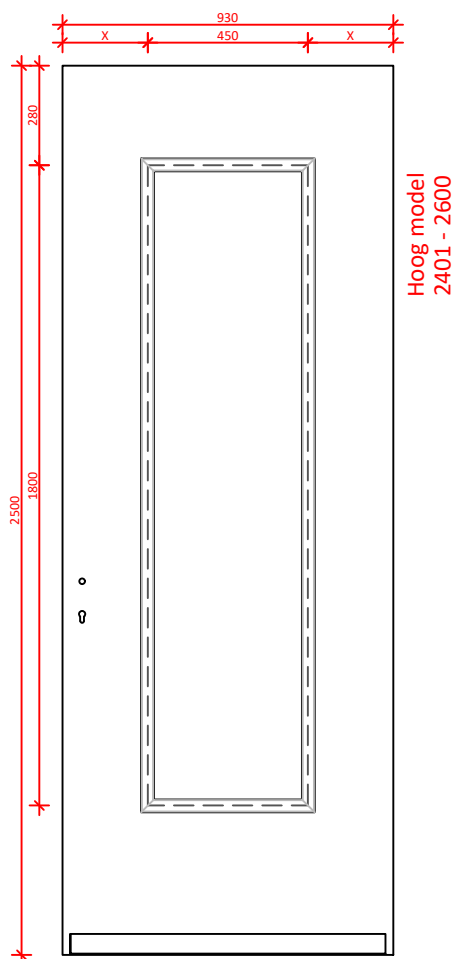
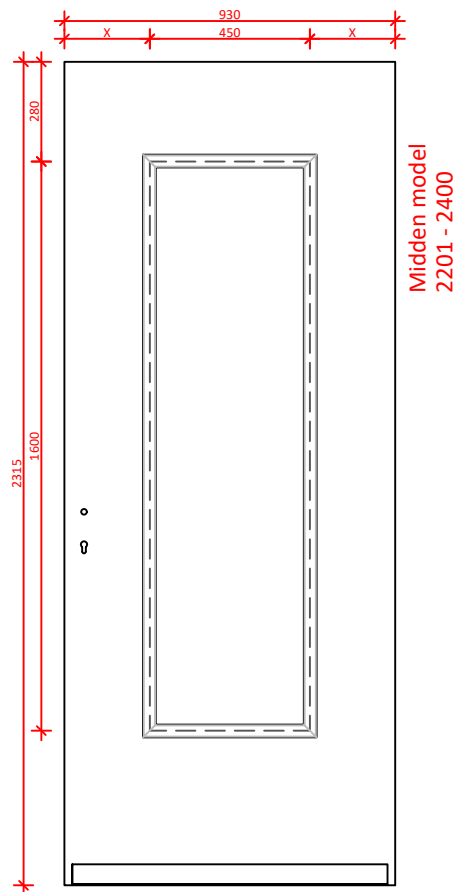
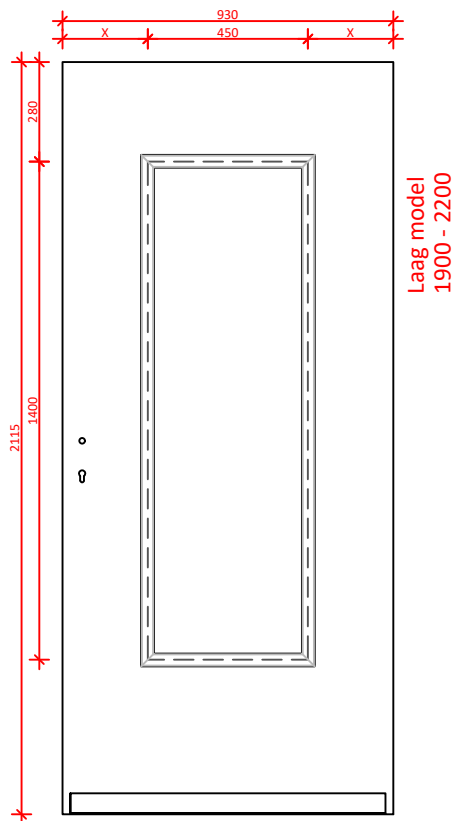

| | | | | | |
|--------|------------|---------------|-------------|-----------------|------------|
| DATUM: | GEWIJZIGD: | CALCULATIENR: | TEKENINGNR: | MODEL: 9195N | HOUTSOORT: |
|--------|------------|---------------|-------------|-----------------|------------|

| | | | | |
|--|--------------------------------------------|--|--|-------------|
| | KLANT/PROJECT: overzicht modellen 9195N | | | DCM NUMMER: |
|--|--------------------------------------------|--|--|-------------|

| | | | | |
|-----------|---------|-----------------|------------|-----------|
| AANVRAAG: | SCHAAL: | GETEKEND: MN | LEVERWEEK: | 1.2a P.29 |
|-----------|---------|-----------------|------------|-----------|

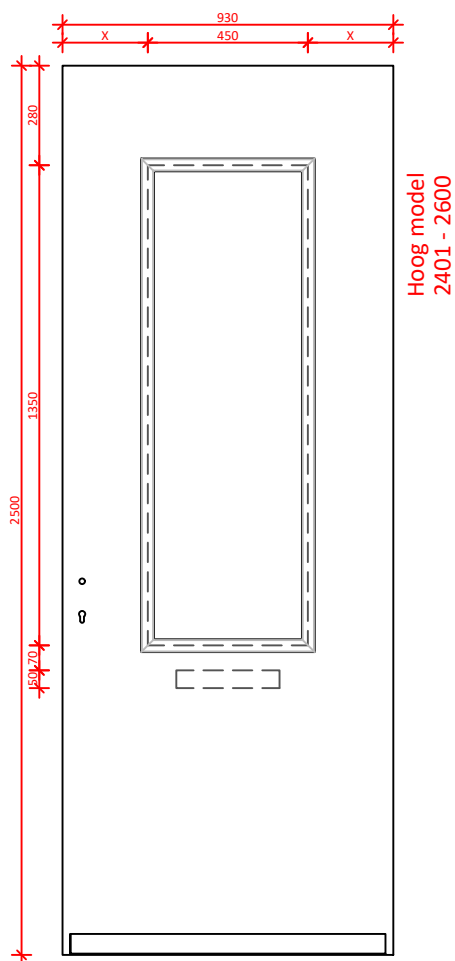
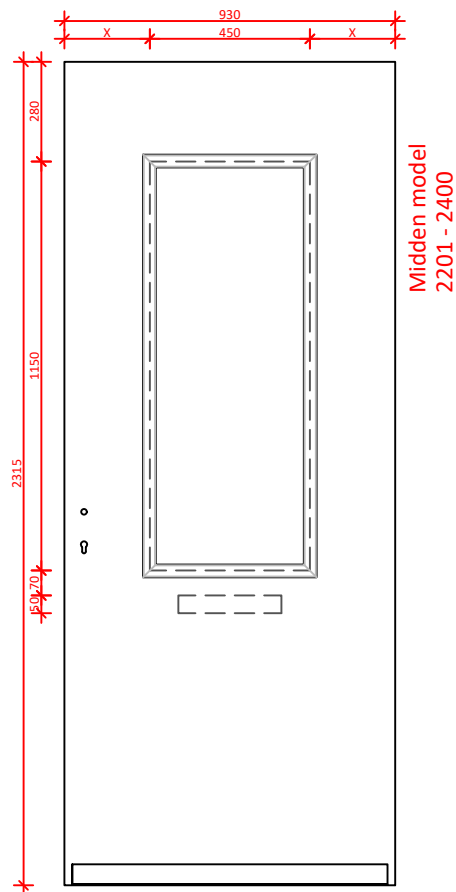
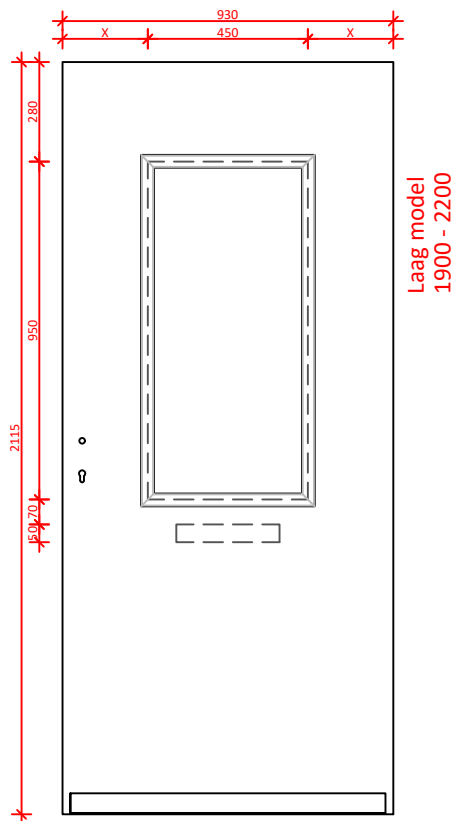

| | | | | | |
|--------|------------|---------------|-------------|-----------------|------------|
| DATUM: | GEWIJZIGD: | CALCULATIENR: | TEKENINGNR: | MODEL: 9196N | HOUTSOORT: |
|--------|------------|---------------|-------------|-----------------|------------|

| | | | | |
|------------------------------------------------------------------------------------|--------------------------------------------|--|--|-------------|
|  | KLANT/PROJECT: overzicht modellen 9196N | | | DCM NUMMER: |
|------------------------------------------------------------------------------------|--------------------------------------------|--|--|-------------|

| | | | | |
|-----------|---------|-----------------|------------|-----------|
| AANVRAAG: | SCHAAL: | GETEKEND: MN | LEVERWEEK: | 1.2a P.30 |
|-----------|---------|-----------------|------------|-----------|

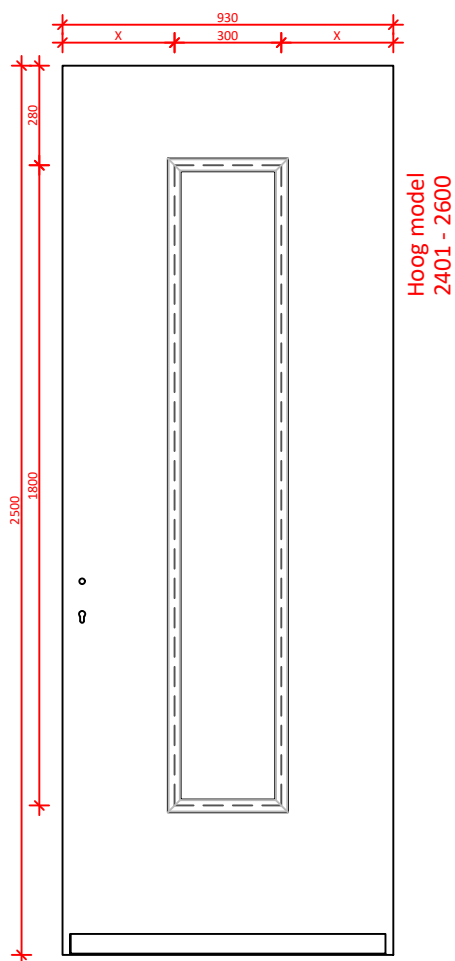
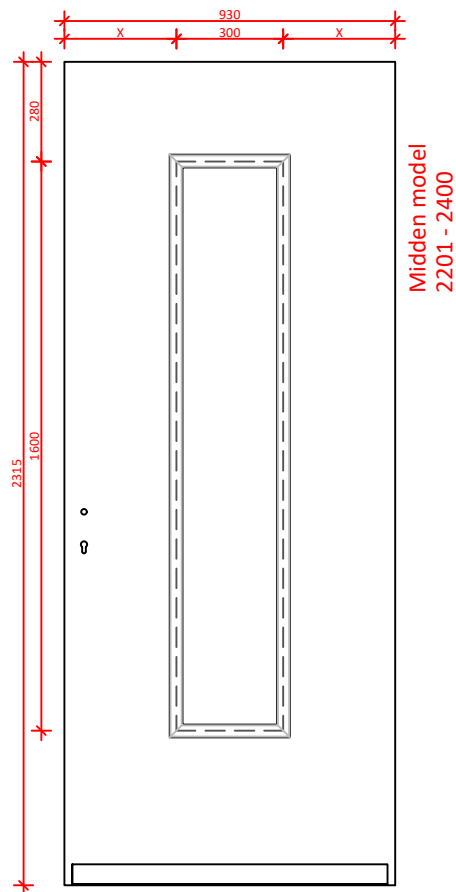
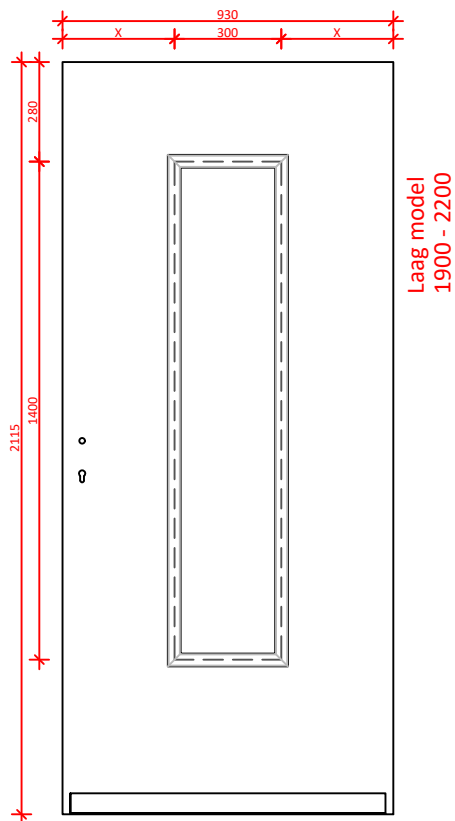

| | | | | | |
|--------|------------|---------------|-------------|-----------------|------------|
| DATUM: | GEWIJZIGD: | CALCULATIENR: | TEKENINGNR: | MODEL: 9197N | HOUTSOORT: |
|--------|------------|---------------|-------------|-----------------|------------|

| | | | | |
|--|--------------------------------------------|--|--|-------------|
| | KLANT/PROJECT: overzicht modellen 9197N | | | DCM NUMMER: |
|--|--------------------------------------------|--|--|-------------|

| | | | | |
|-----------|---------|-----------------|------------|-----------|
| AANVRAAG: | SCHAAL: | GETEKEND: MN | LEVERWEEK: | 1.2a P.31 |
|-----------|---------|-----------------|------------|-----------|

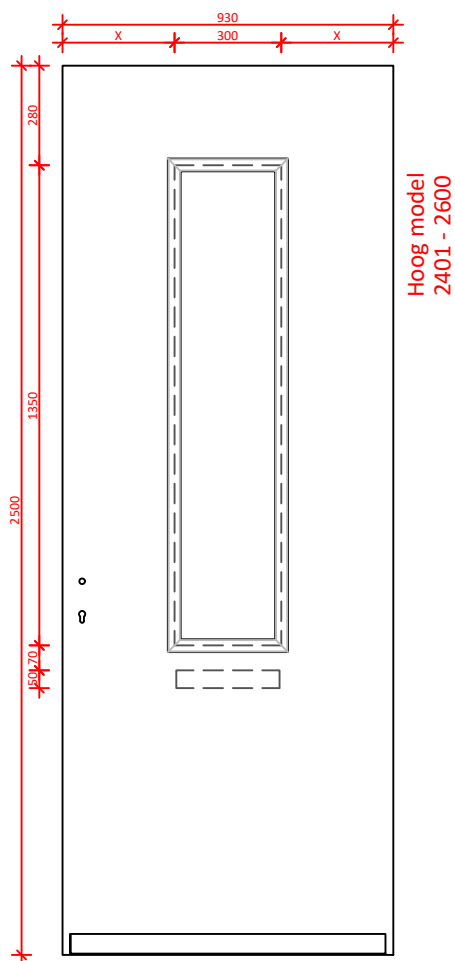
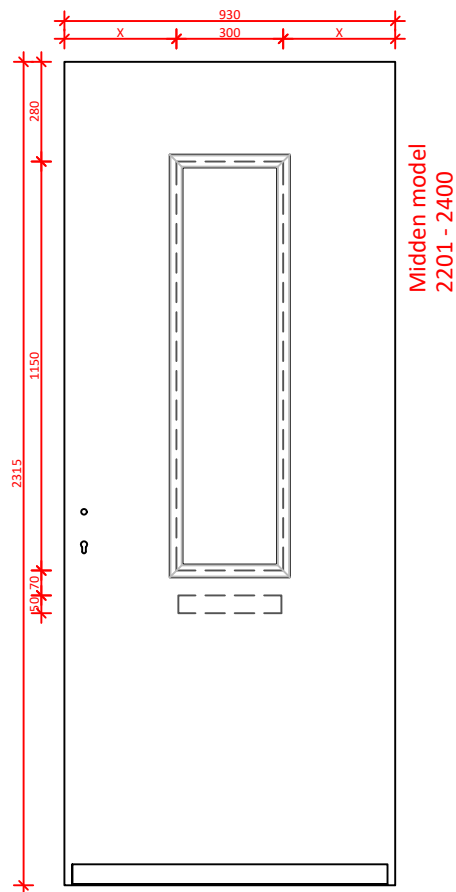
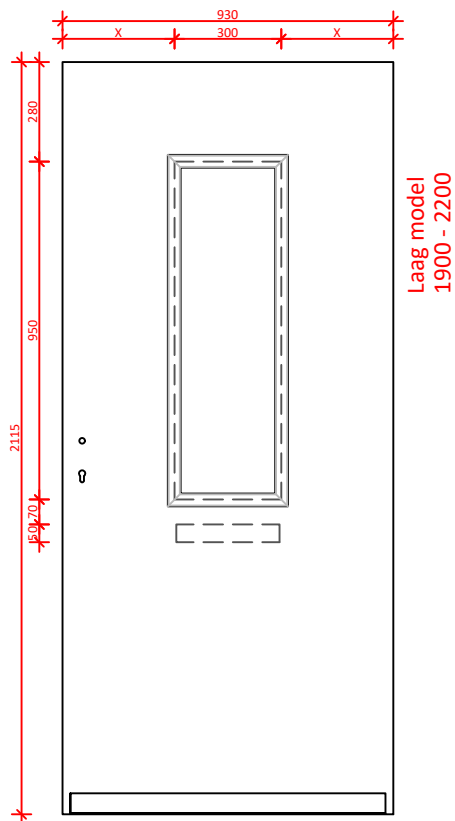

| | | | | | |
|--------|------------|---------------|-------------|-----------------|------------|
| DATUM: | GEWIJZIGD: | CALCULATIENR: | TEKENINGNR: | MODEL: 9198N | HOUTSOORT: |
|--------|------------|---------------|-------------|-----------------|------------|

| | | | | |
|--|--------------------------------------------|--|--|-------------|
| | KLANT/PROJECT: overzicht modellen 9198N | | | DCM NUMMER: |
|--|--------------------------------------------|--|--|-------------|

| | | | | |
|-----------|---------|-----------------|------------|-----------|
| AANVRAAG: | SCHAAL: | GETEKEND: MN | LEVERWEEK: | 1.2a P.32 |
|-----------|---------|-----------------|------------|-----------|

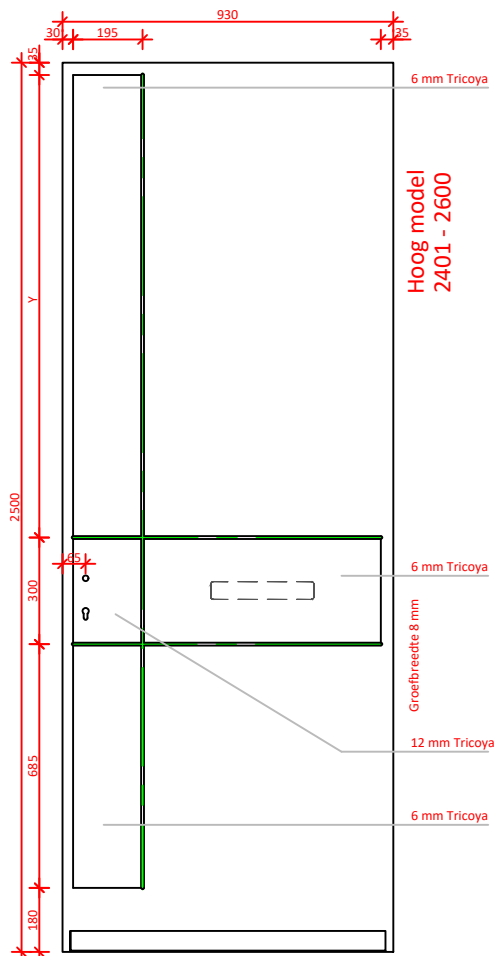
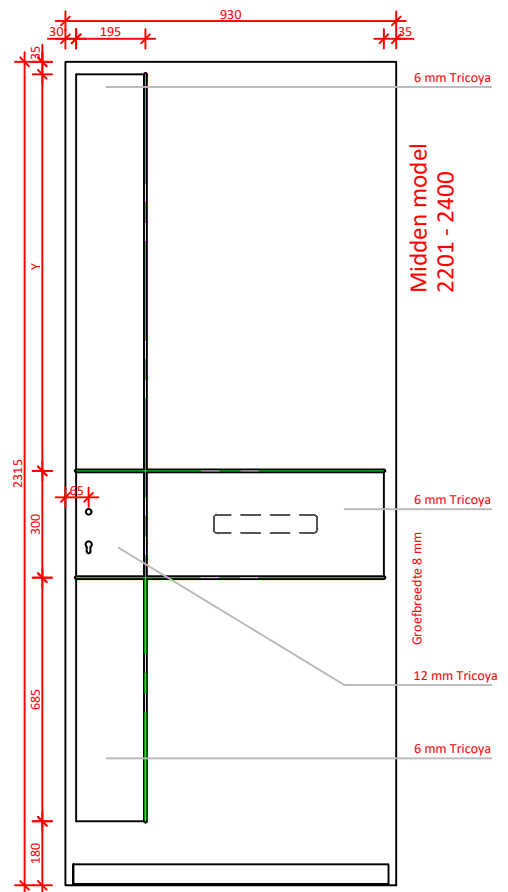
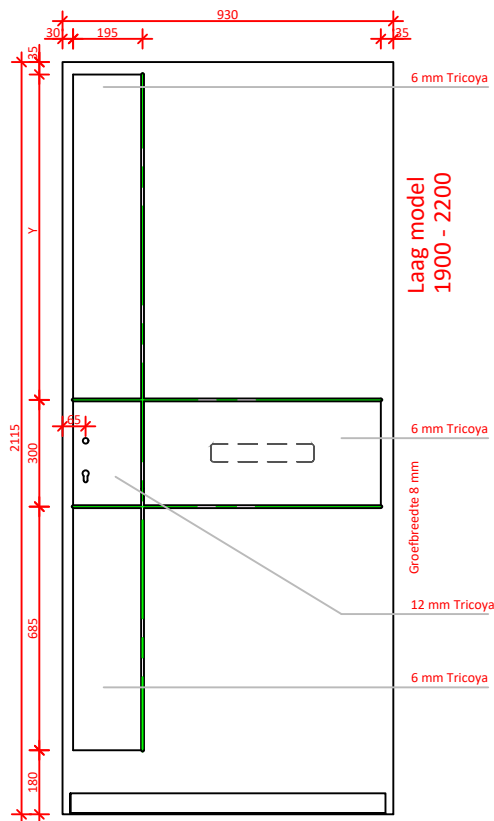

MAATVOERING WIJZIGT INDIEN SENIOREN SLOT WORDT TOEGEPAST
MINIMAAL DOORNMAAT 65 TOEPASSEN IVM MOGELIJKE BVT OPLOSSING EN PLAATMATERIAAL

| | | | | | |
|--------|------------|---------------|-------------|----------------|------------|
| DATUM: | GEWIJZIGD: | CALCULATIENR: | TEKENINGNR: | MODEL: 9401 | HOUTSOORT: |
|--------|------------|---------------|-------------|----------------|------------|

| | | | | |
|--|---------------------------------------------------|--|--|-------------|
| | KLANT/PROJECT: overzicht modellen 9401 L1 - R4 | | | DCM NUMMER: |
|--|---------------------------------------------------|--|--|-------------|

| | | | |
|-----------|---------|-----------------|-------------------------|
| AANVRAAG: | SCHAAL: | GETEKEND: MN | LEVERWEEK: 1.2a P.33 |
|-----------|---------|-----------------|-------------------------|

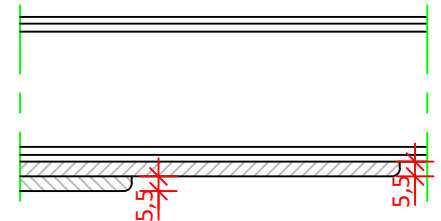
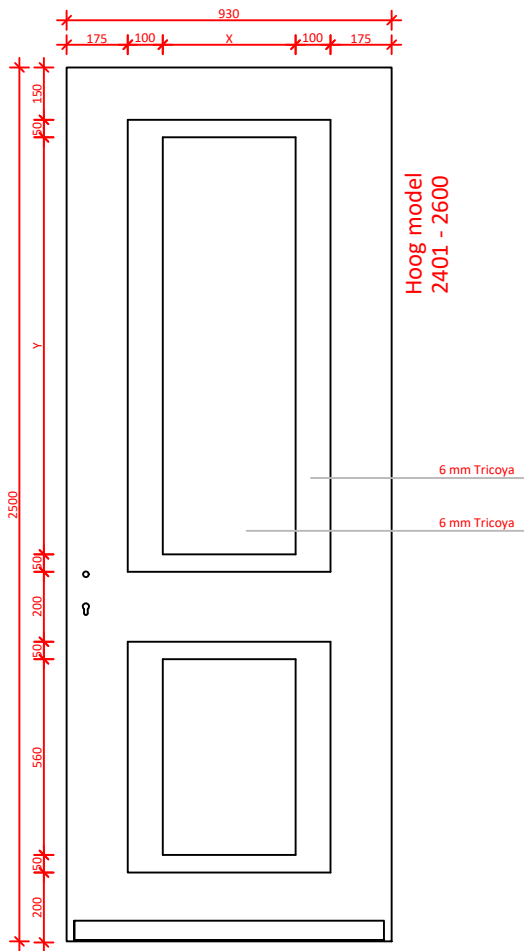
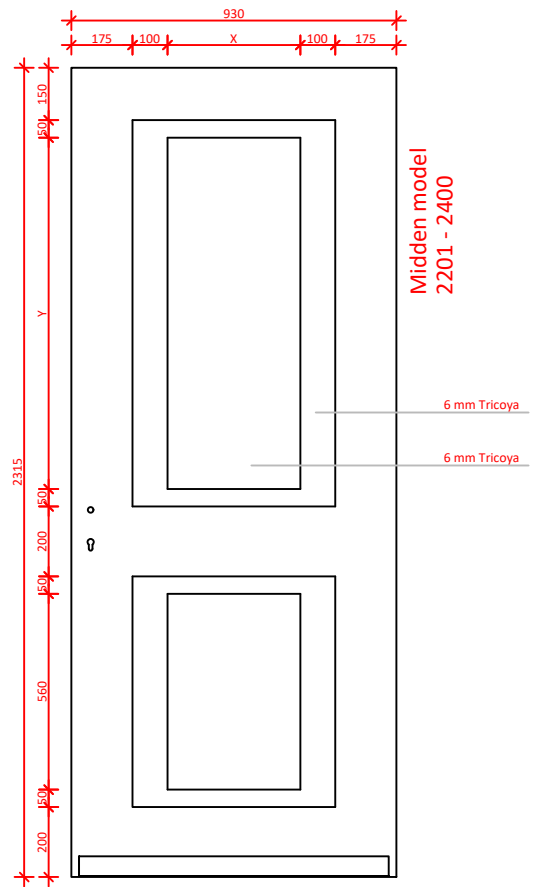
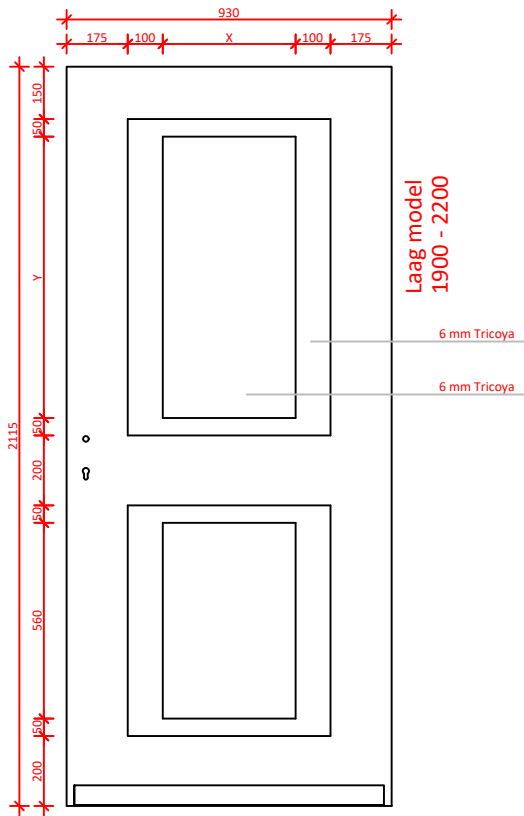

| | | | | | |
|--------|------------|---------------|-------------|----------------|------------|
| DATUM: | GEWIJZIGD: | CALCULATIENR: | TEKENINGNR: | MODEL: 9406 | HOUTSOORT: |
|--------|------------|---------------|-------------|----------------|------------|

| | | | | |
|-----------------------|-------------------------------------------|--|--|-------------|
| KEGRO DEUREN | KLANT/PROJECT: overzicht modellen 9406 | | | DCM NUMMER: |
|-----------------------|-------------------------------------------|--|--|-------------|

| | | | | |
|-----------|---------|-----------------|------------|-----------|
| AANVRAAG: | SCHAAL: | GETEKEND: MN | LEVERWEEK: | 1.2a P.34 |
|-----------|---------|-----------------|------------|-----------|

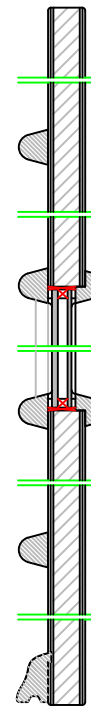
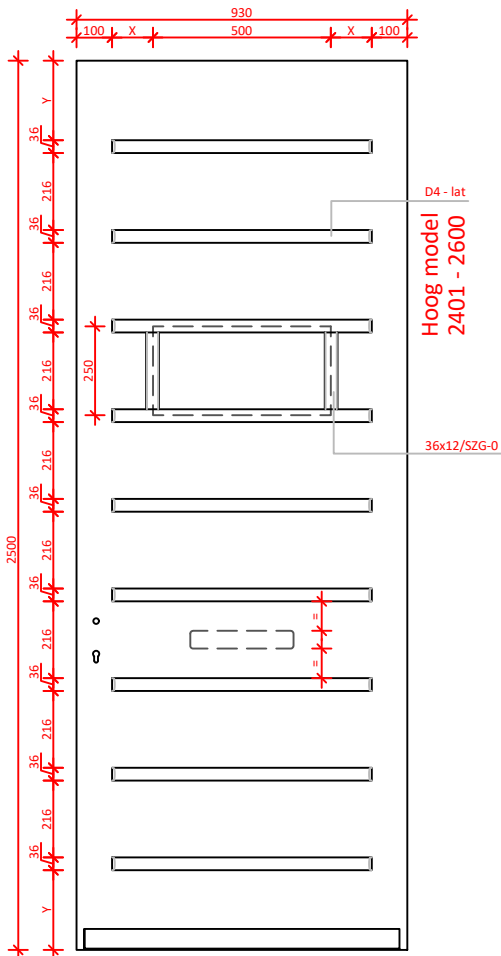
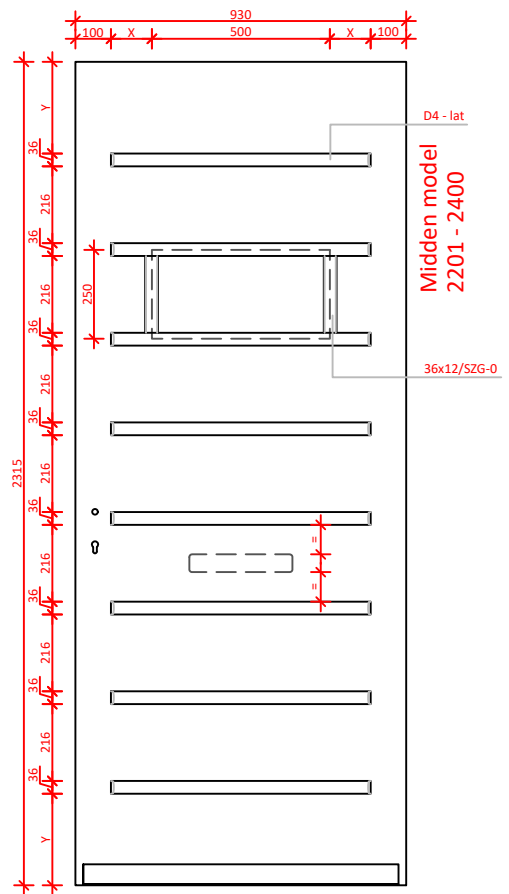
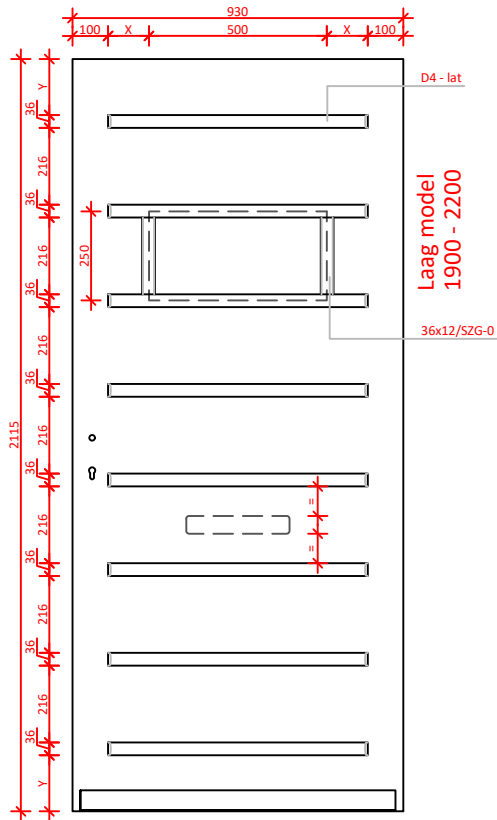

Strakke SponningMaat

- Pasmaat deurbreedte t/m 1000 mm : SSM 500mm
- Pasmaat deurbreedte 1001 t/m 1100 mm : SSM 600mm
- Pasmaat deurbreedte > 1101 mm : SSM 700mm

| | | | | | |
|------------------------------------------------------------------------------------|------------|---------------|--------------------------------------------|-------------------------|-------------|
| DATUM: | GEWIJZIGD: | CALCULATIENR: | TEKENINGNR: | MODEL: 9431N | HOUTSOORT: |
|  | | | KLANT/PROJECT: overzicht modellen 9431N | | DCM NUMMER: |
| AANVRAAG: | | SCHAAL: | GETEKEND: MN | LEVERWEEK: 1.2a P.35 | |

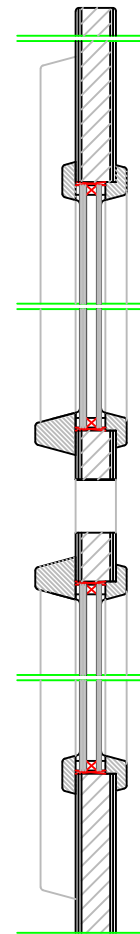
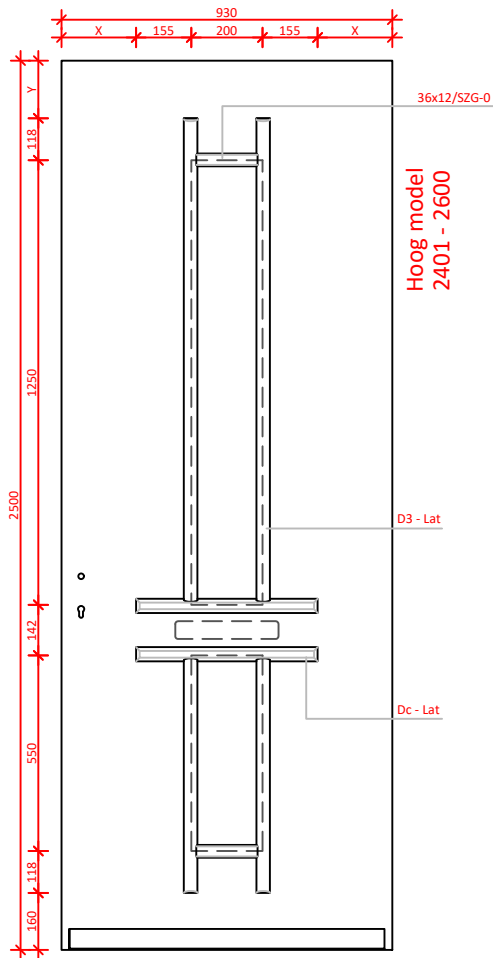
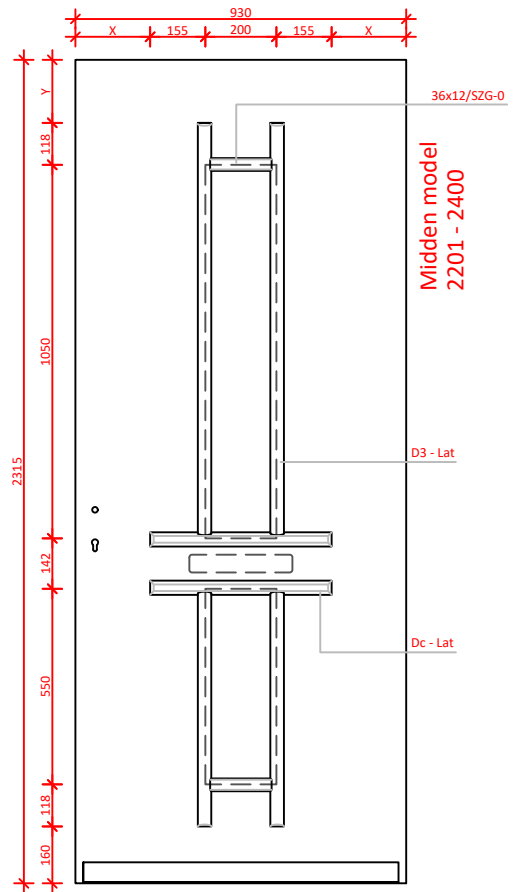
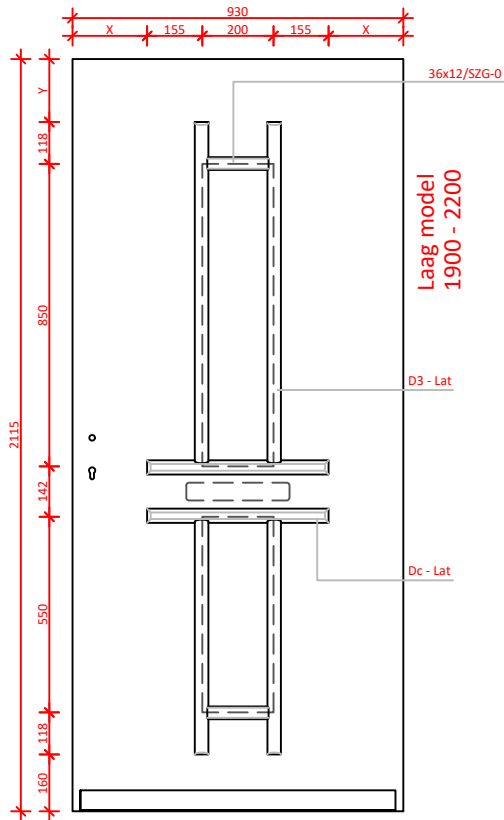

| | | | | | |
|--------|------------|---------------|-------------|-----------------|------------|
| DATUM: | GEWIJZIGD: | CALCULATIENR: | TEKENINGNR: | MODEL: 9432N | HOUTSOORT: |
|--------|------------|---------------|-------------|-----------------|------------|

| | | | | |
|--|--------------------------------------------|--|--|-------------|
| | KLANT/PROJECT: overzicht modellen 9432N | | | DCM NUMMER: |
|--|--------------------------------------------|--|--|-------------|

| | | | | |
|-----------|---------|-----------------|------------|-----------|
| AANVRAAG: | SCHAAL: | GETEKEND: MN | LEVERWEEK: | 1.2a P.36 |
|-----------|---------|-----------------|------------|-----------|

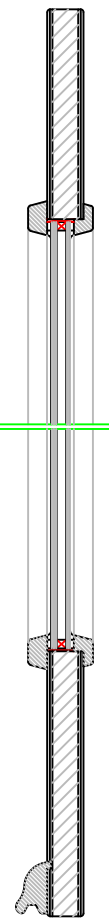
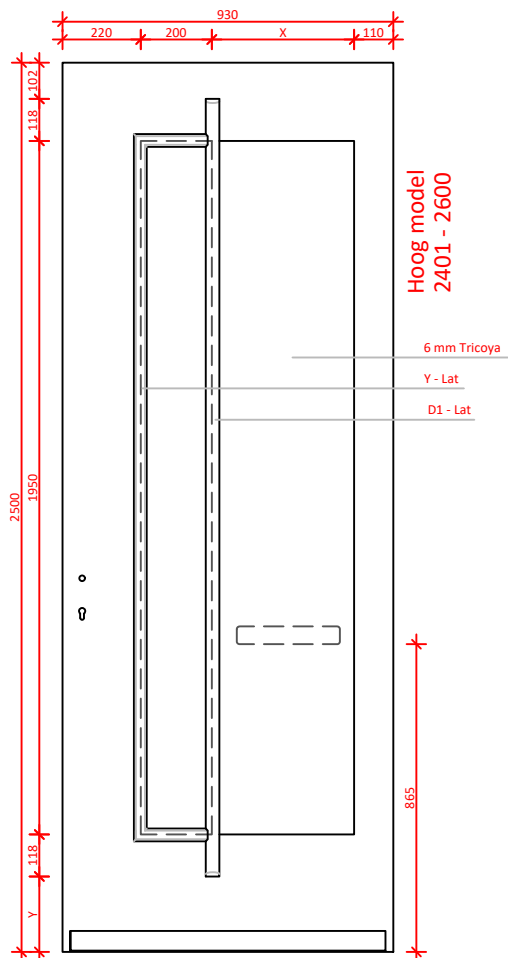
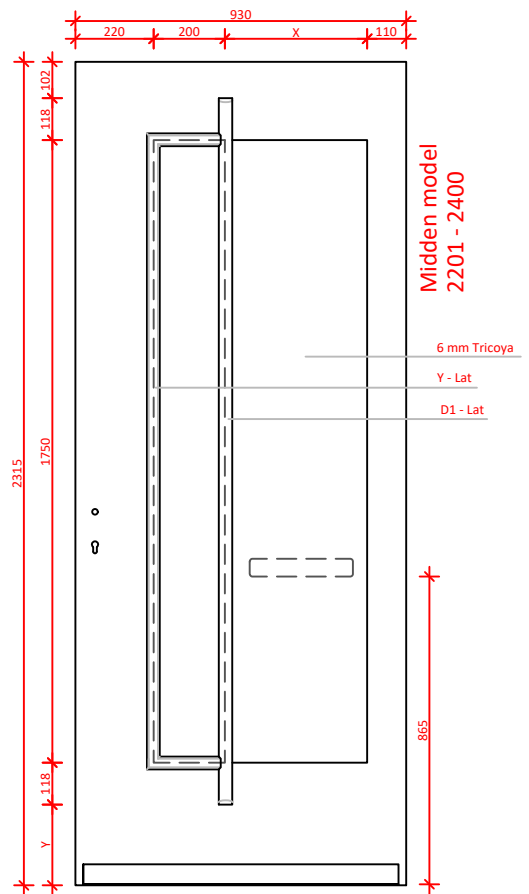
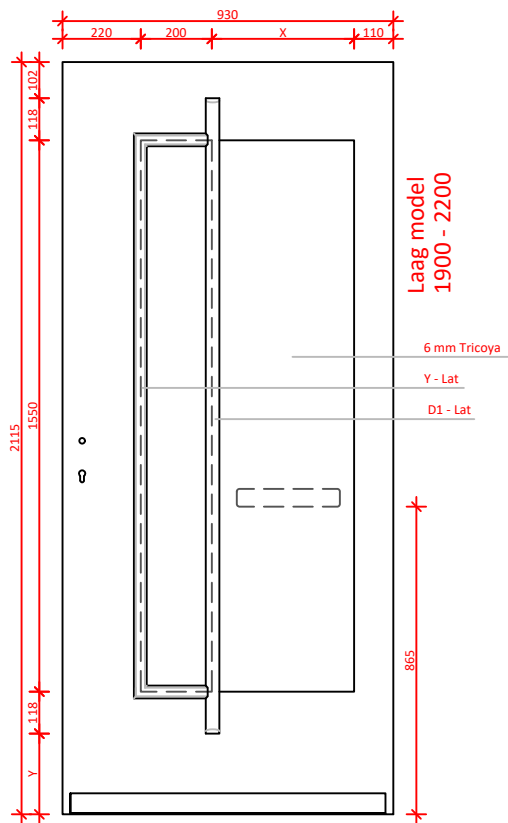

| | | | | | |
|--------|------------|---------------|-------------|-----------------|------------|
| DATUM: | GEWIJZIGD: | CALCULATIENR: | TEKENINGNR: | MODEL: 9433N | HOUTSOORT: |
|--------|------------|---------------|-------------|-----------------|------------|

| | | | | |
|-----------------------|----------------------------------------------------|--|--|-------------|
| KEGRO DEUREN | KLANT/PROJECT: overzicht modellen 9433N L1 - R4 | | | DCM NUMMER: |
|-----------------------|----------------------------------------------------|--|--|-------------|

| | | | |
|-----------|---------|-----------------|-------------------------|
| AANVRAAG: | SCHAAL: | GETEKEND: MN | LEVERWEEK: 1.2a P.37 |
|-----------|---------|-----------------|-------------------------|

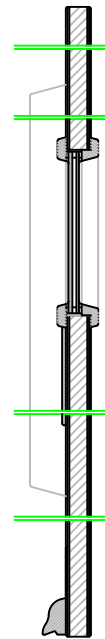
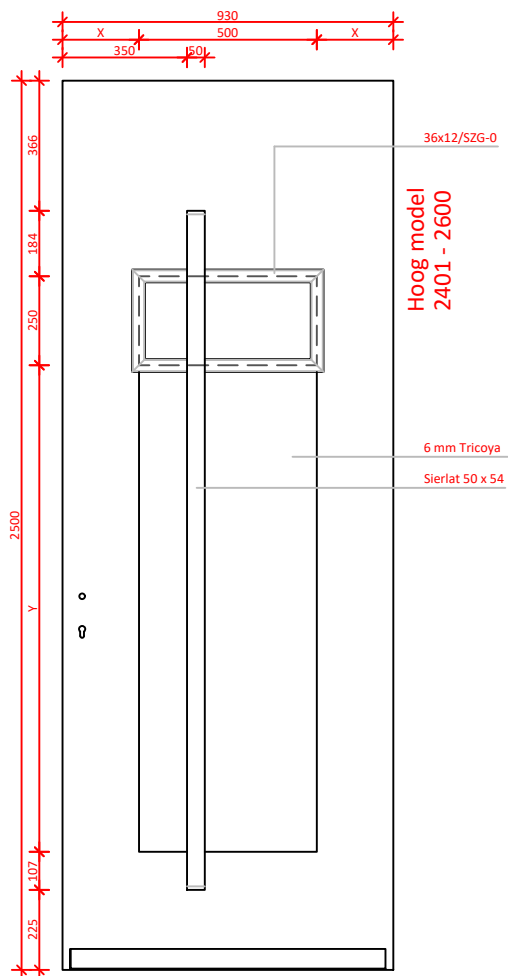
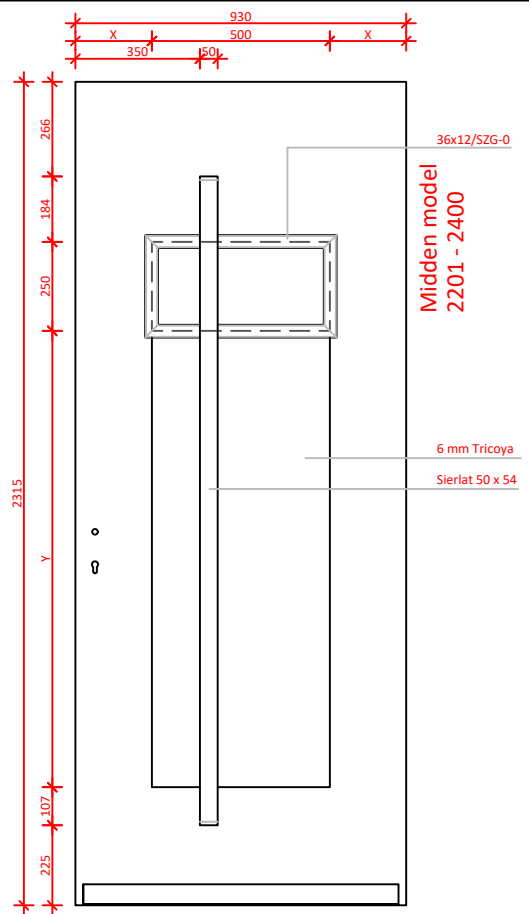
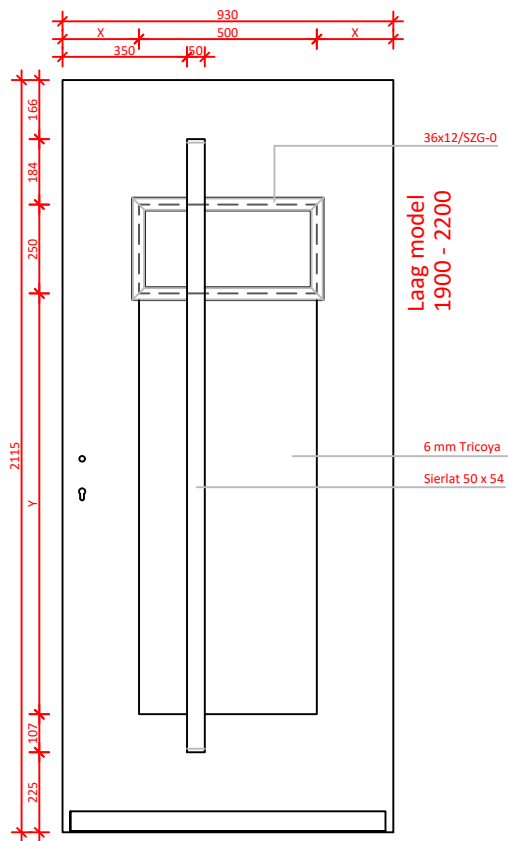

Strakke SponningMaat
 Pasmaat deurbreedte t/m 1000 mm : SSM 500mm
 Pasmaat deurbreedte 1001 t/m 1100 mm : SSM 600mm
 Pasmaat deurbreedte > 1101 mm : SSM 700mm

| | | | | | |
|--------|------------|---------------|-------------|-----------------|------------|
| DATUM: | GEWIJZIGD: | CALCULATIENR: | TEKENINGNR: | MODEL: 9434N | HOUTSOORT: |
|--------|------------|---------------|-------------|-----------------|------------|

| | | | | |
|--|----------------------------------------------------|--|--|-------------|
| | KLANT/PROJECT: overzicht modellen 9434N L1 - R4 | | | DCM NUMMER: |
|--|----------------------------------------------------|--|--|-------------|

| | | | |
|-----------|---------|-----------------|-------------------------|
| AANVRAAG: | SCHAAL: | GETEKEND: MN | LEVERWEEK: 1.2a P.38 |
|-----------|---------|-----------------|-------------------------|

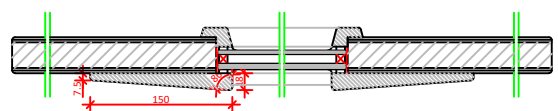
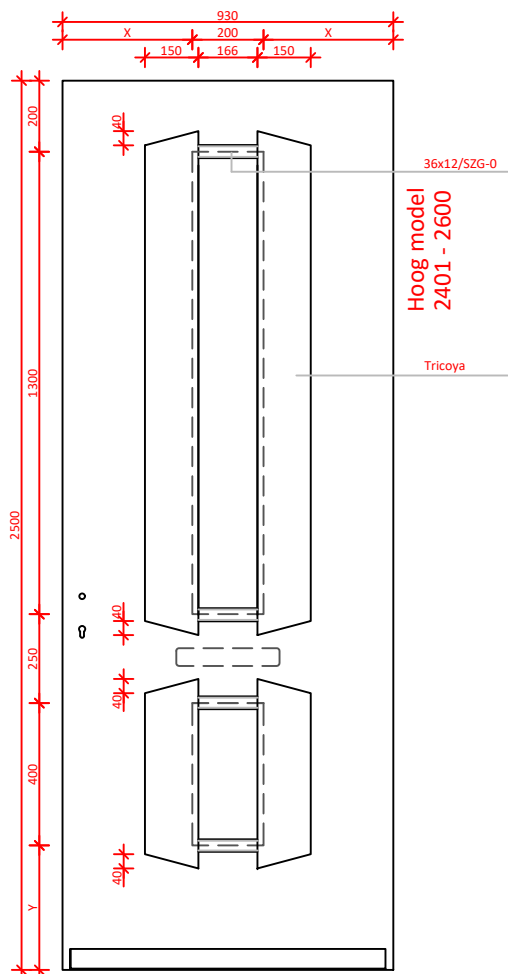
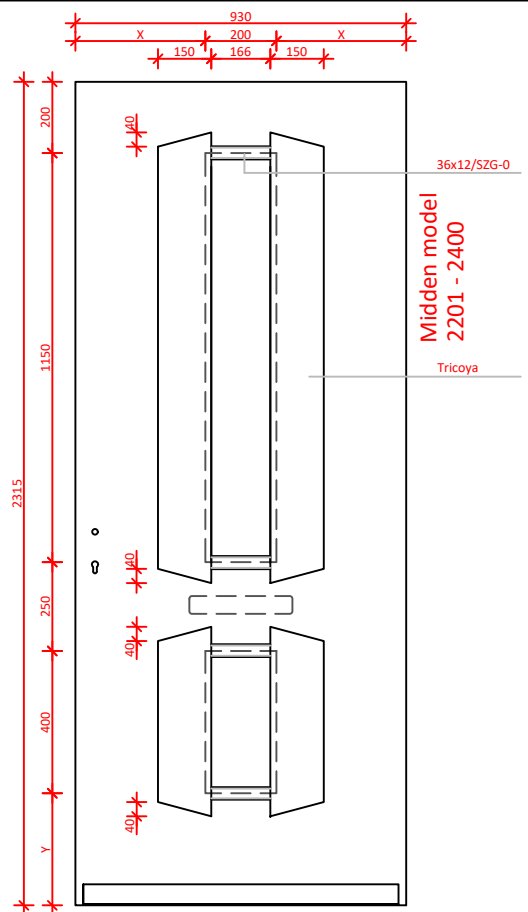
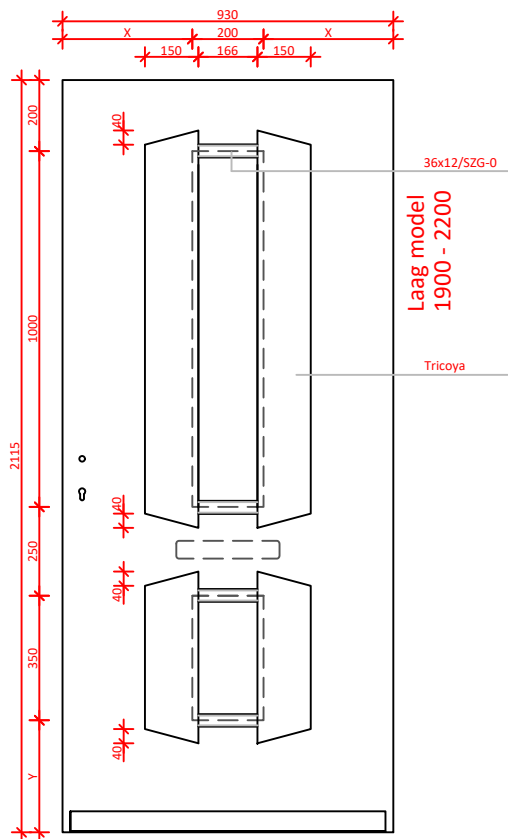

| | | | | | |
|--------|------------|---------------|-------------|-----------------|------------|
| DATUM: | GEWIJZIGD: | CALCULATIENR: | TEKENINGNR: | MODEL: 9435N | HOUTSOORT: |
|--------|------------|---------------|-------------|-----------------|------------|

| | | | | |
|--|--------------------------------------------|--|--|-------------|
| | KLANT/PROJECT: overzicht modellen 9435N | | | DCM NUMMER: |
|--|--------------------------------------------|--|--|-------------|

| | | | | |
|-----------|---------|-----------------|------------|-----------|
| AANVRAAG: | SCHAAL: | GETEKEND: MN | LEVERWEEK: | 1.2a P.39 |
|-----------|---------|-----------------|------------|-----------|

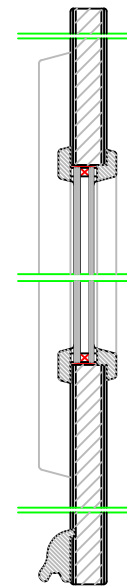
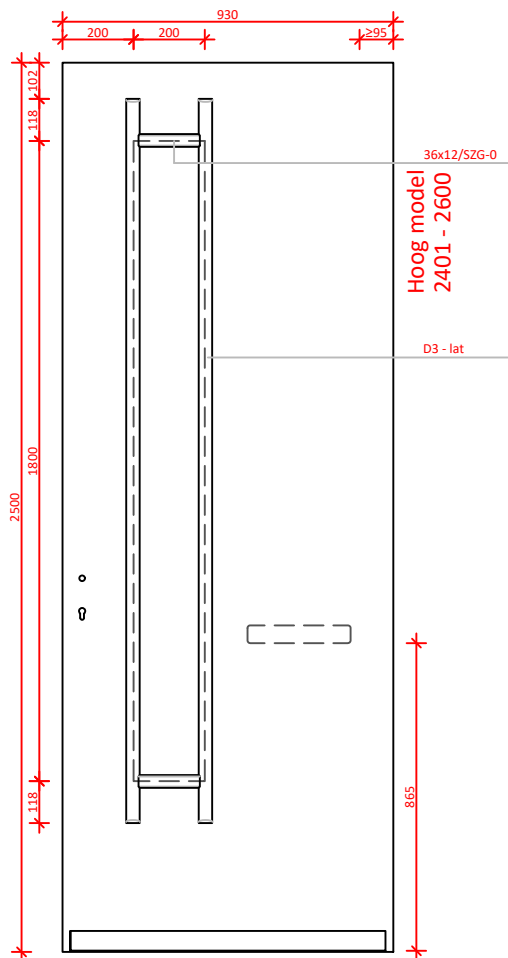
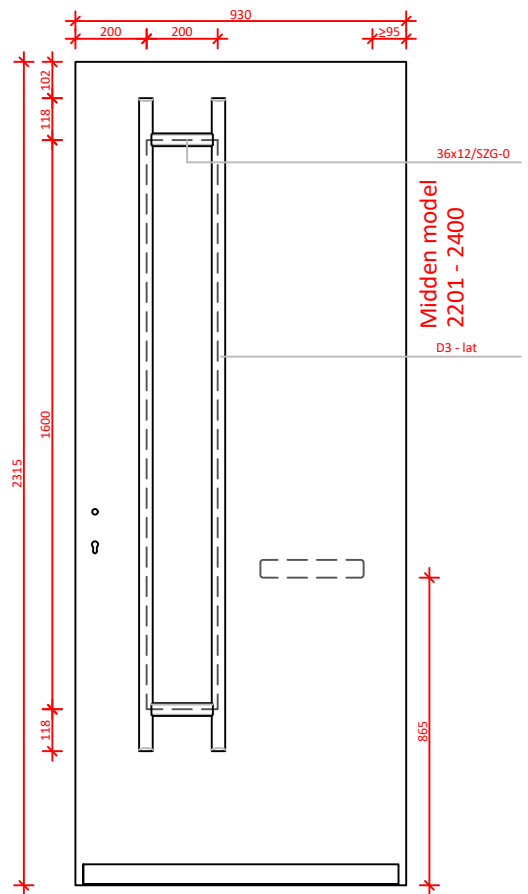
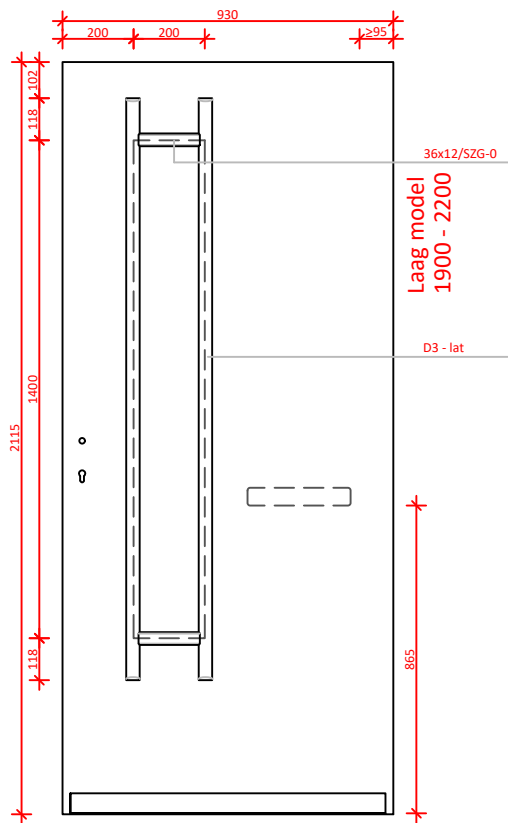

| | | | | | |
|--------|------------|---------------|-------------|-----------------|------------|
| DATUM: | GEWIJZIGD: | CALCULATIENR: | TEKENINGNR: | MODEL: 9436N | HOUTSOORT: |
|--------|------------|---------------|-------------|-----------------|------------|

| | | | | |
|--|--------------------------------------------|--|--|-------------|
| | KLANT/PROJECT: overzicht modellen 9436N | | | DCM NUMMER: |
|--|--------------------------------------------|--|--|-------------|

| | | | | |
|-----------|---------|-----------------|------------|-----------|
| AANVRAAG: | SCHAAL: | GETEKEND: MN | LEVERWEEK: | 1.2a P.40 |
|-----------|---------|-----------------|------------|-----------|

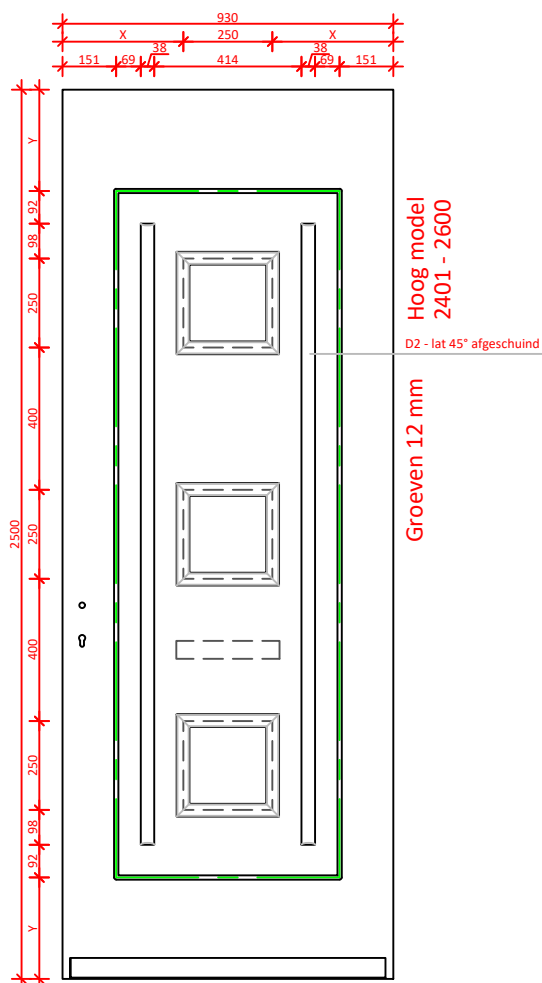
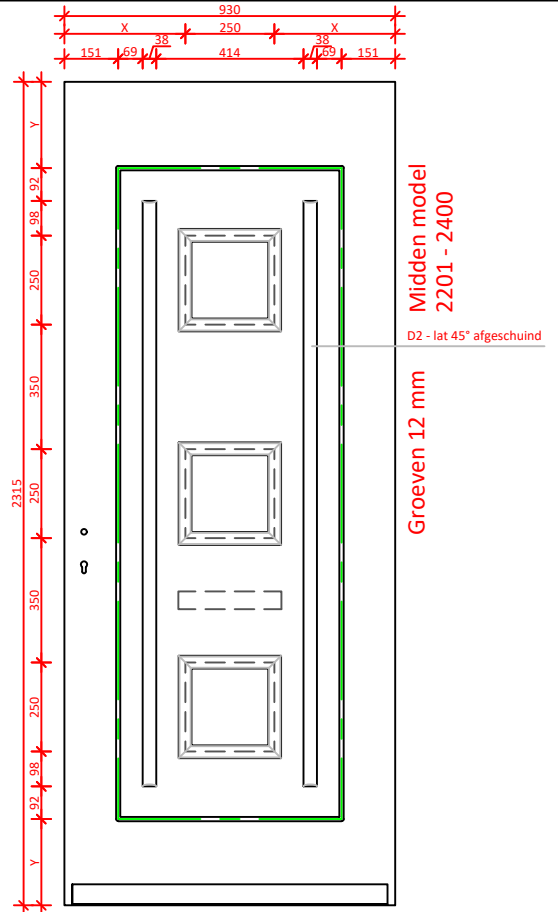
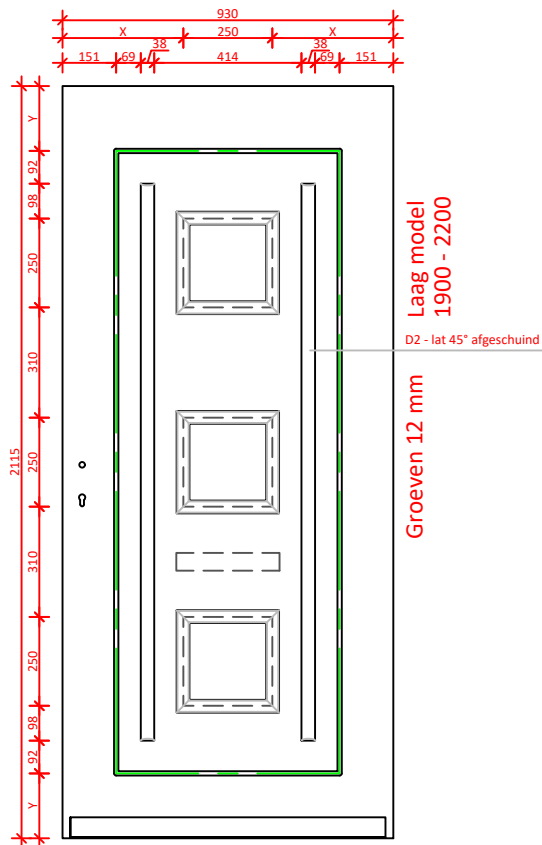

| | | | | | |
|--------|------------|---------------|-------------|-----------------|------------|
| DATUM: | GEWIJZIGD: | CALCULATIENR: | TEKENINGNR: | MODEL: 9460N | HOUTSOORT: |
|--------|------------|---------------|-------------|-----------------|------------|

| | | | | |
|--|--------------------------------------------|--|--|-------------|
| | KLANT/PROJECT: overzicht modellen 9460N | | | DCM NUMMER: |
|--|--------------------------------------------|--|--|-------------|

| | | | | |
|-----------|---------|-----------------|------------|-----------|
| AANVRAAG: | SCHAAL: | GETEKEND: MN | LEVERWEEK: | 1.2a P.41 |
|-----------|---------|-----------------|------------|-----------|

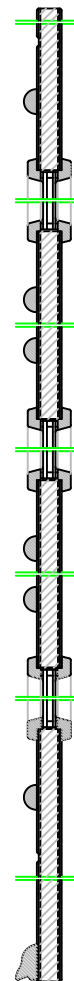
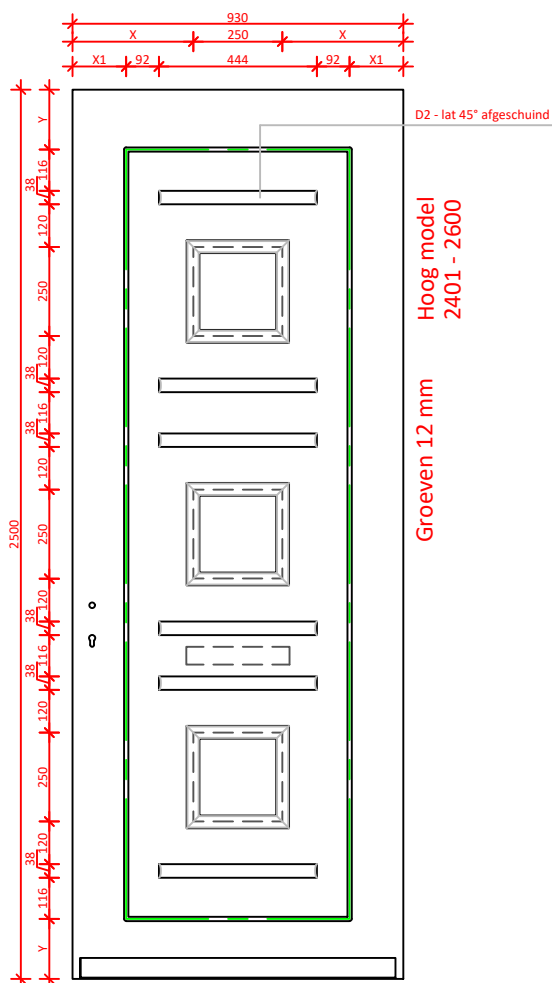
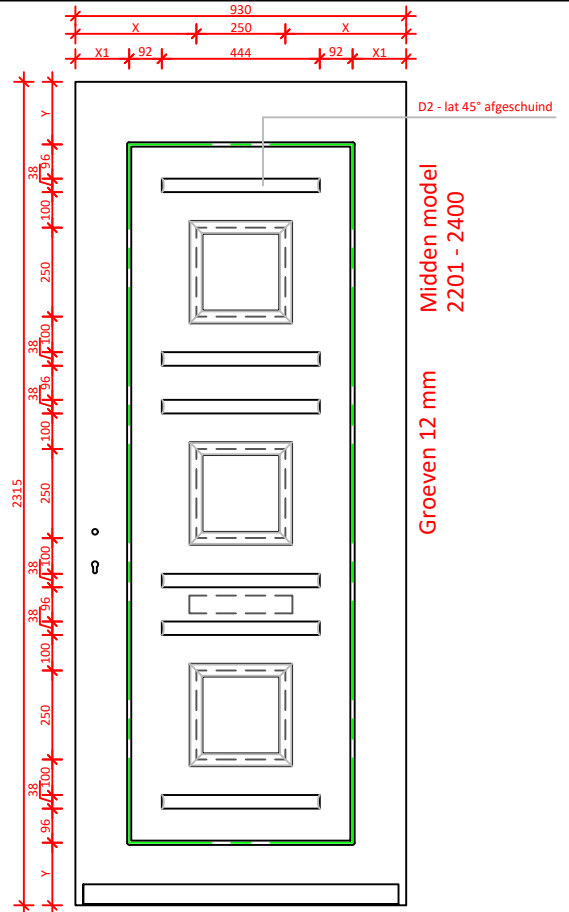
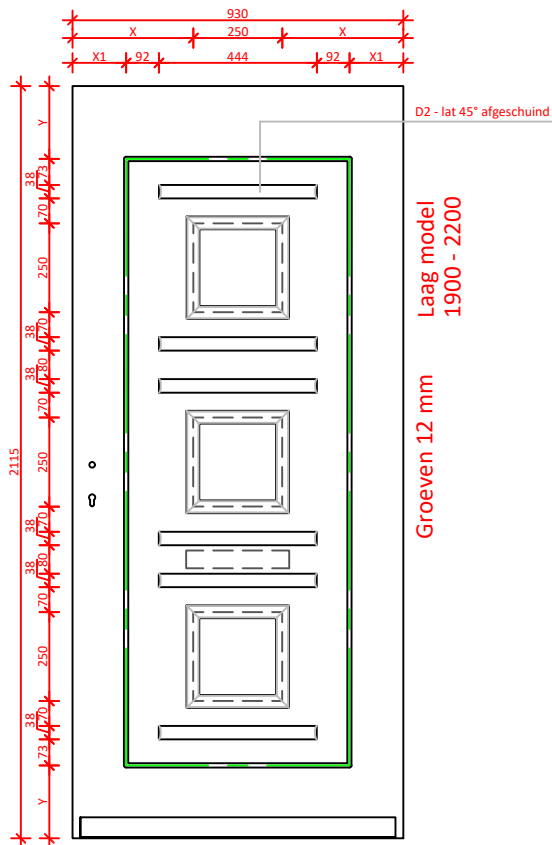

| | | | | | |
|--------|------------|---------------|-------------|-----------------|------------|
| DATUM: | GEWIJZIGD: | CALCULATIENR: | TEKENINGNR: | MODEL: 9461N | HOUTSOORT: |
|--------|------------|---------------|-------------|-----------------|------------|

| | | | | |
|--|--------------------------------------------|--|--|-------------|
| | KLANT/PROJECT: overzicht modellen 9461N | | | DCM NUMMER: |
|--|--------------------------------------------|--|--|-------------|

| | | | |
|-----------|---------|-----------------|-------------------------|
| AANVRAAG: | SCHAAL: | GETEKEND: MN | LEVERWEEK: 1.2a P.42 |
|-----------|---------|-----------------|-------------------------|

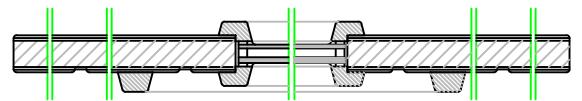
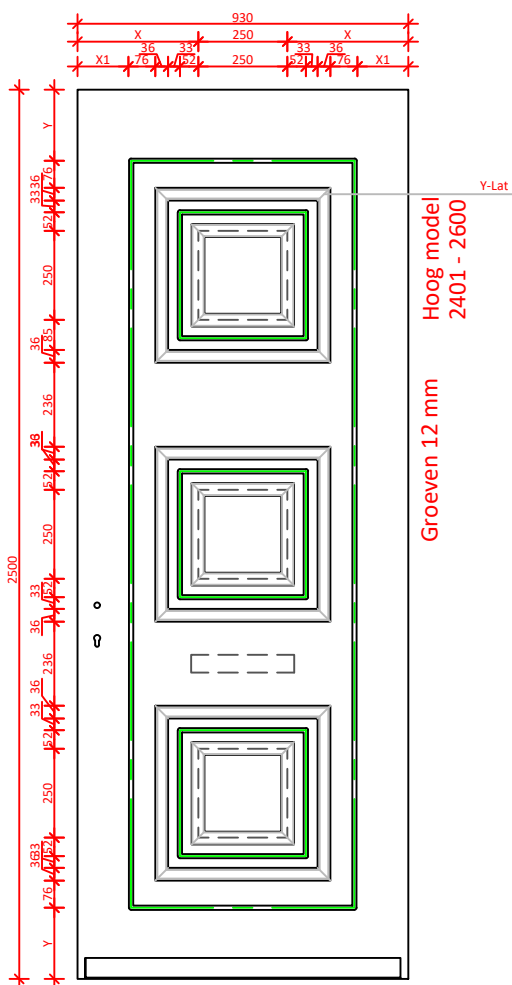
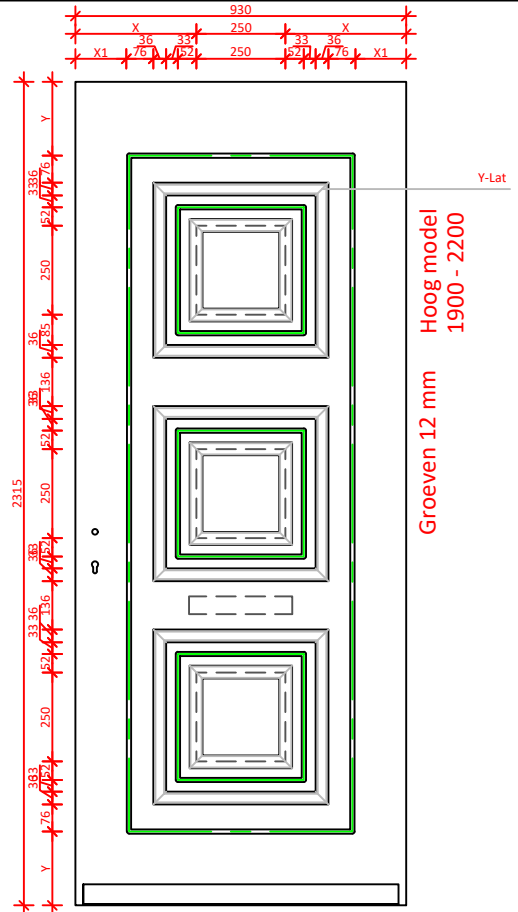
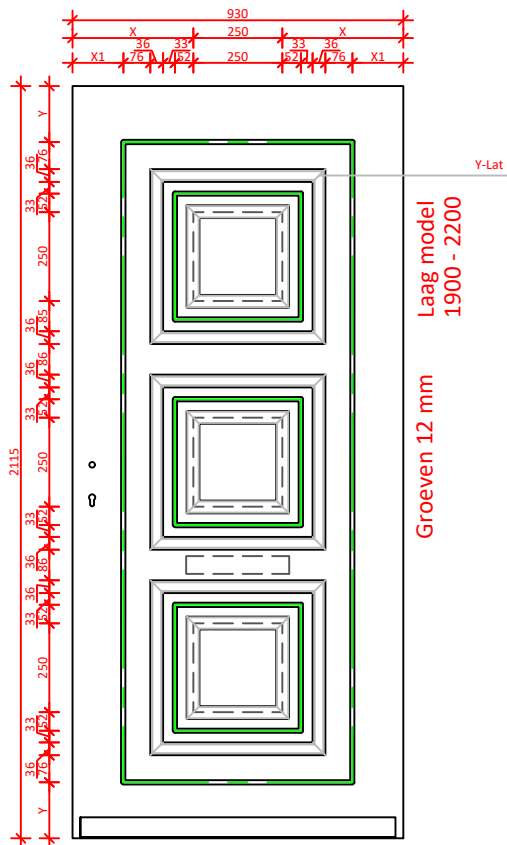

| | | | | | |
|--------|------------|---------------|-------------|-----------------|------------|
| DATUM: | GEWIJZIGD: | CALCULATIENR: | TEKENINGNR: | MODEL: 9462N | HOUTSOORT: |
|--------|------------|---------------|-------------|-----------------|------------|

| | | | | |
|--|--------------------------------------------|--|--|-------------|
| | KLANT/PROJECT: overzicht modellen 9462N | | | DCM NUMMER: |
|--|--------------------------------------------|--|--|-------------|

| | | | | |
|-----------|---------|-----------------|------------|-----------|
| AANVRAAG: | SCHAAL: | GETEKEND: MN | LEVERWEEK: | 1.2a P.43 |
|-----------|---------|-----------------|------------|-----------|

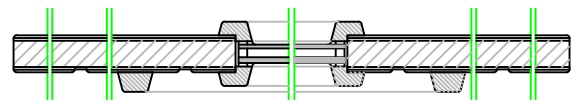
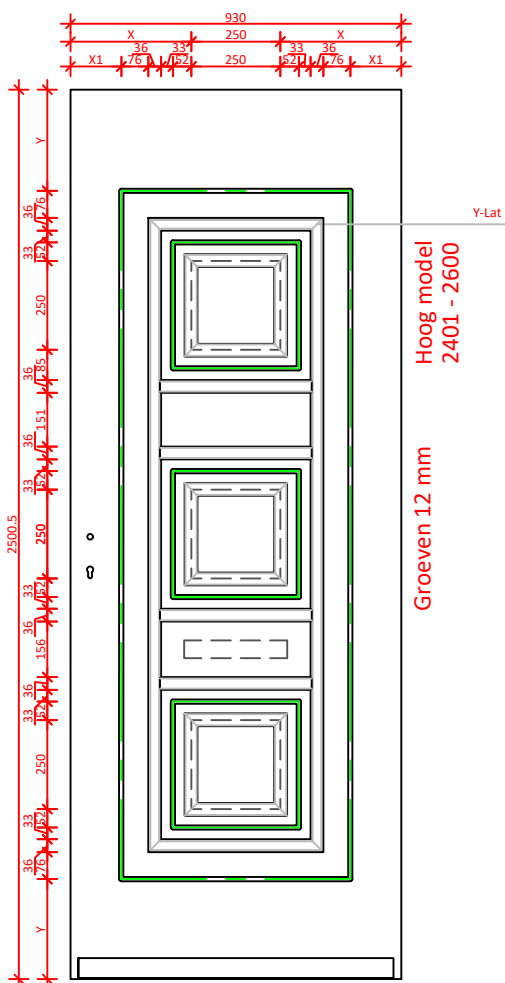
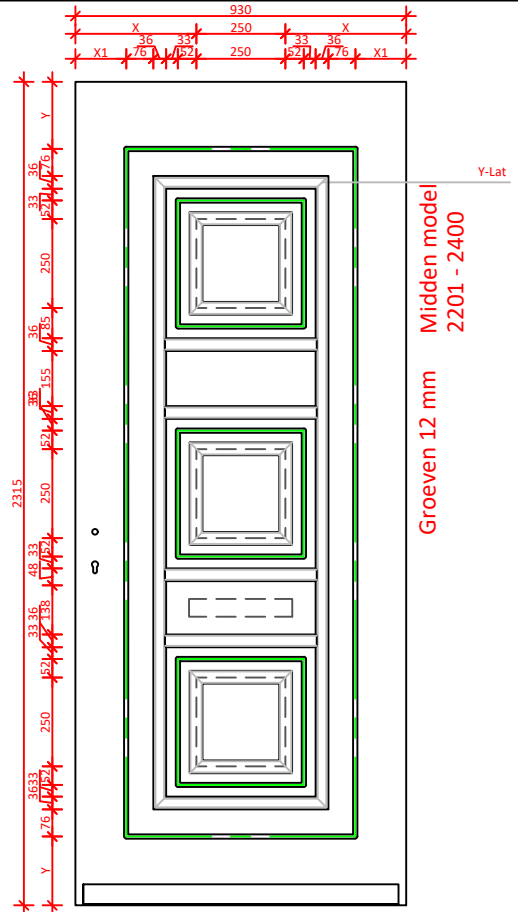
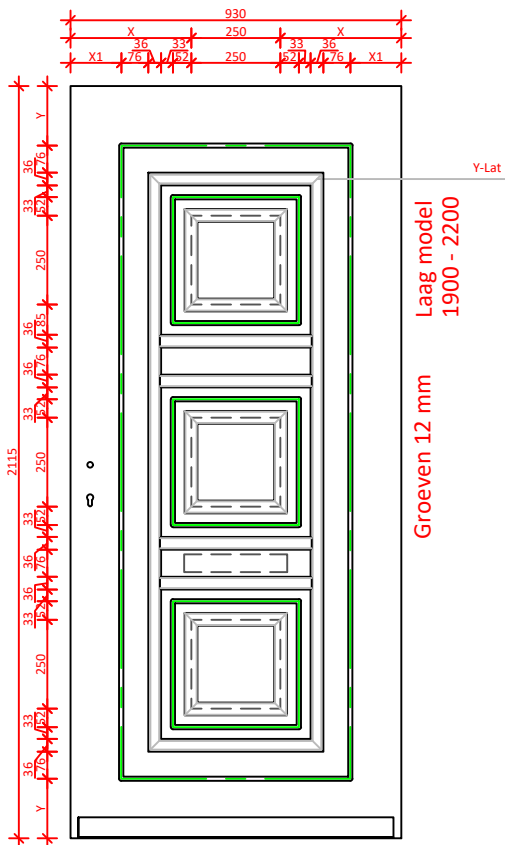

| | | | | | |
|--------|------------|---------------|-------------|-----------------|------------|
| DATUM: | GEWIJZIGD: | CALCULATIENR: | TEKENINGNR: | MODEL: 9463N | HOUTSOORT: |
|--------|------------|---------------|-------------|-----------------|------------|

| | | | | |
|--|--------------------------------------------|--|--|-------------|
| | KLANT/PROJECT: overzicht modellen 9463N | | | DCM NUMMER: |
|--|--------------------------------------------|--|--|-------------|

| | | | | |
|-----------|---------|-----------------|------------|-----------|
| AANVRAAG: | SCHAAL: | GETEKEND: MN | LEVERWEEK: | 1.2a P.44 |
|-----------|---------|-----------------|------------|-----------|

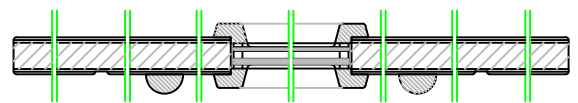
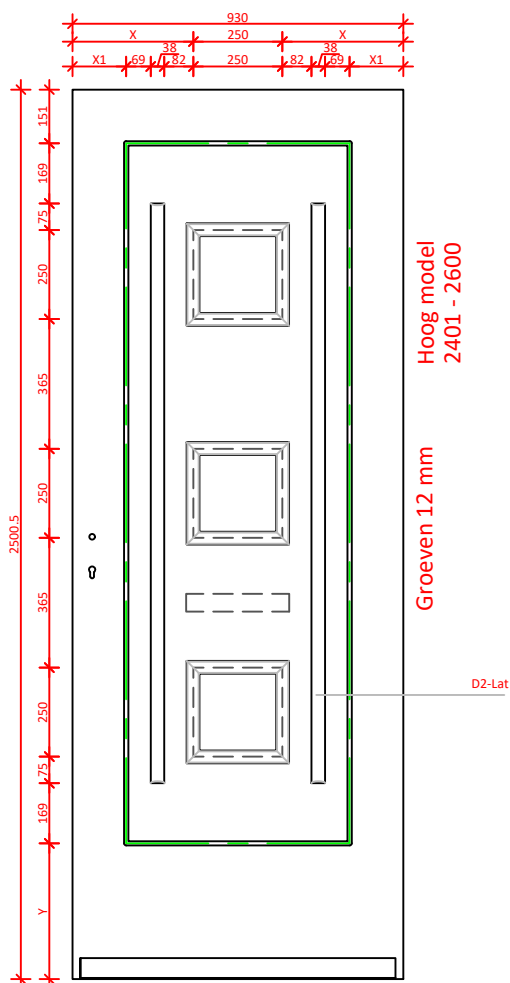
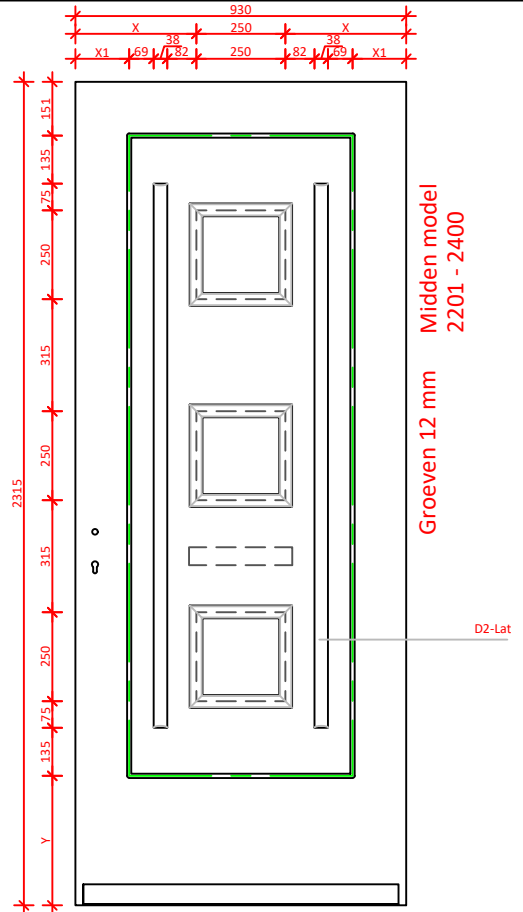
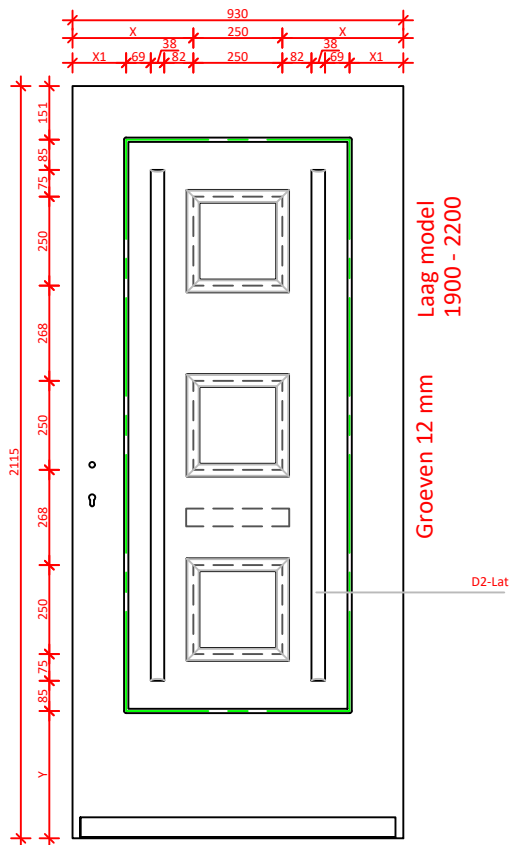

| | | | | | |
|--------|------------|---------------|-------------|-----------------|------------|
| DATUM: | GEWIJZIGD: | CALCULATIENR: | TEKENINGNR: | MODEL: 9464N | HOUTSOORT: |
|--------|------------|---------------|-------------|-----------------|------------|

| | | | | |
|--|--------------------------------------------|--|--|-------------|
| | KLANT/PROJECT: overzicht modellen 9464N | | | DCM NUMMER: |
|--|--------------------------------------------|--|--|-------------|

| | | | | |
|-----------|---------|-----------------|------------|-----------|
| AANVRAAG: | SCHAAL: | GETEKEND: MN | LEVERWEEK: | 1.2a P.45 |
|-----------|---------|-----------------|------------|-----------|

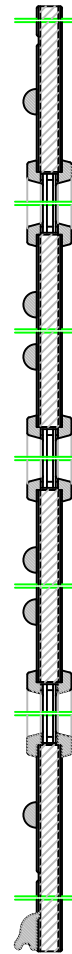
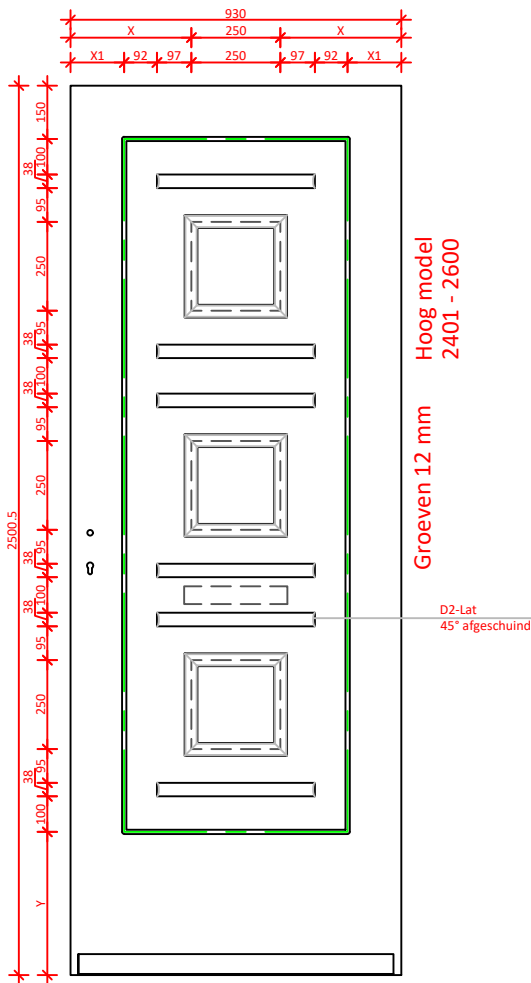
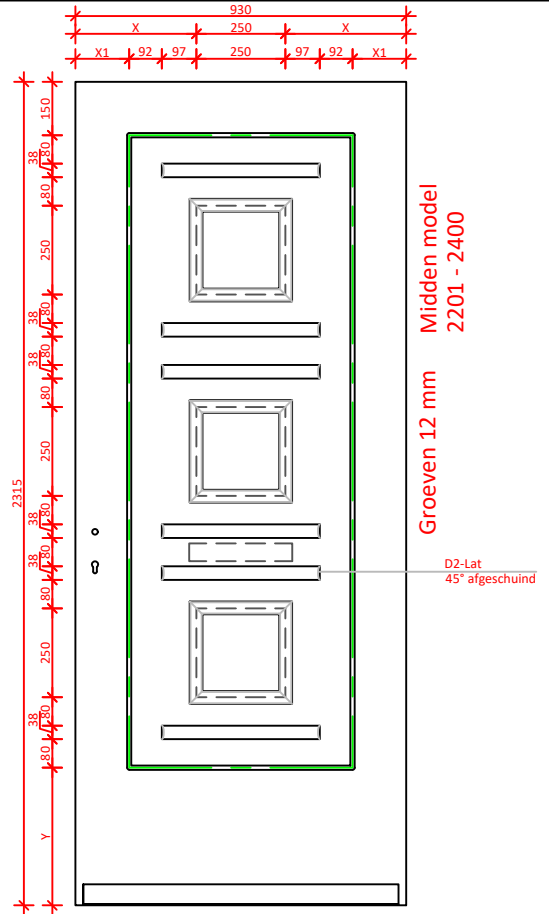
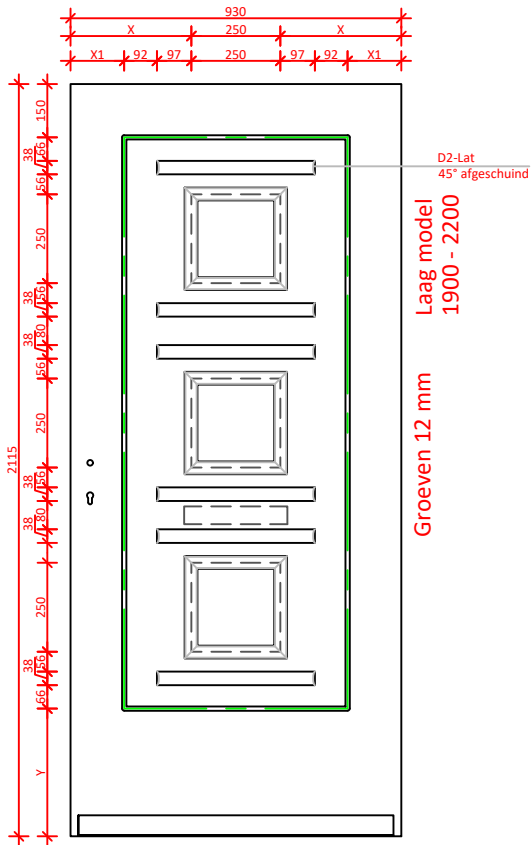

| | | | | | |
|-----------|------------|---------------|--------------------------------------------|-------------------------|------------|
| DATUM: | GEWIJZIGD: | CALCULATIENR: | TEKENINGNR: | MODEL: 9465N | HOUTSOORT: |
| | | | KLANT/PROJECT: overzicht modellen 9465N | DCM NUMMER: | |
| AANVRAAG: | | SCHAAL: | GETEKEND: MN | LEVERWEEK: 1.2a P.46 | |

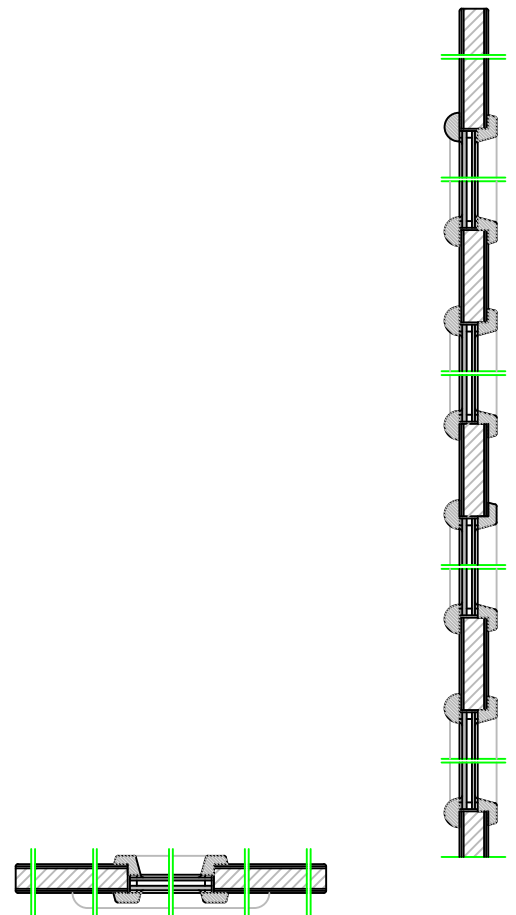
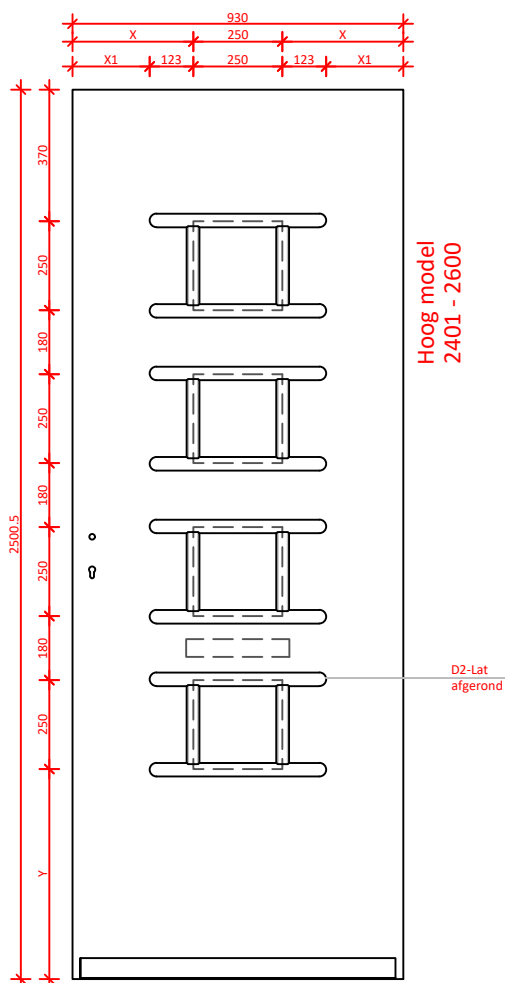
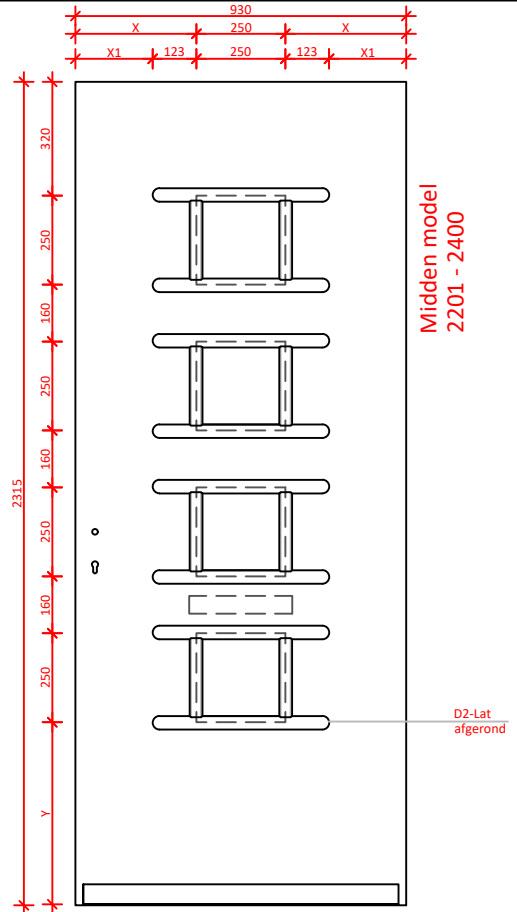
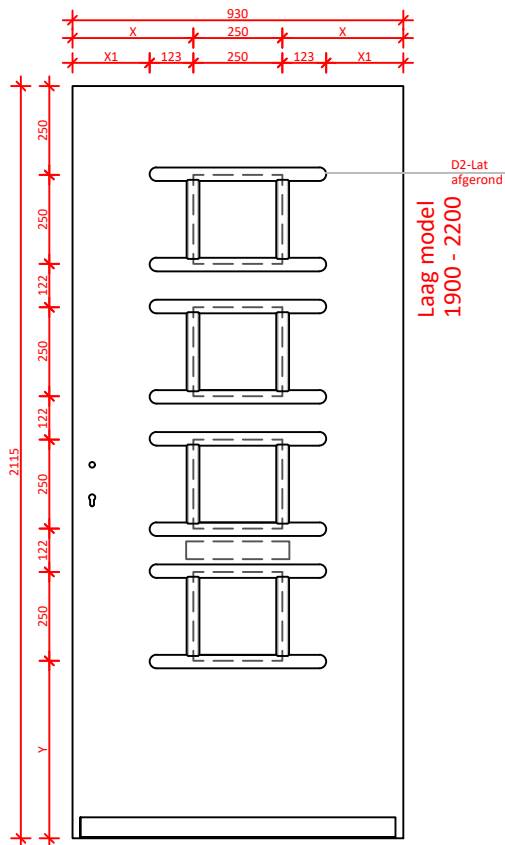

| | | | | | |
|--------|------------|---------------|-------------|-----------------|------------|
| DATUM: | GEWIJZIGD: | CALCULATIENR: | TEKENINGNR: | MODEL: 9466N | HOUTSOORT: |
|--------|------------|---------------|-------------|-----------------|------------|

| | | | | |
|--|--------------------------------------------|--|--|-------------|
| | KLANT/PROJECT: overzicht modellen 9466N | | | DCM NUMMER: |
|--|--------------------------------------------|--|--|-------------|

| | | | | |
|-----------|---------|-----------------|------------|-----------|
| AANVRAAG: | SCHAAL: | GETEKEND: MN | LEVERWEEK: | 1.2a P.47 |
|-----------|---------|-----------------|------------|-----------|

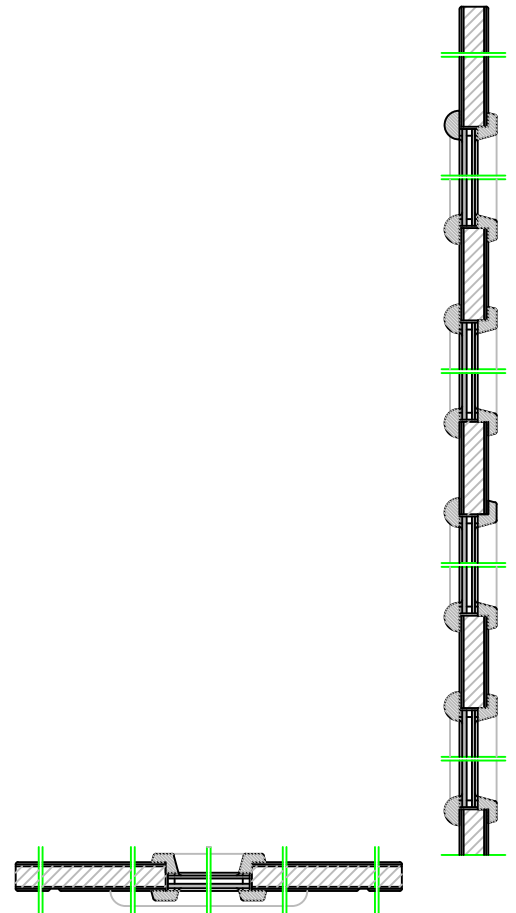
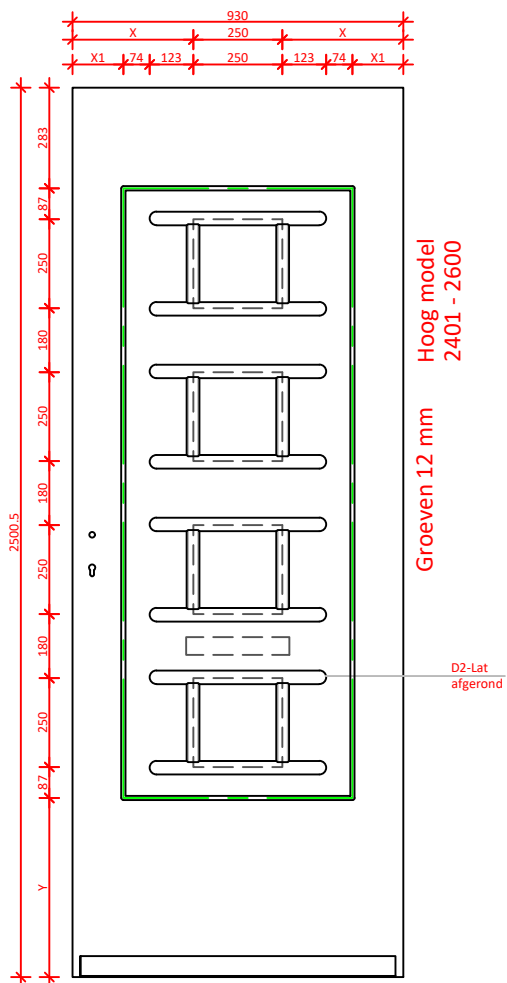
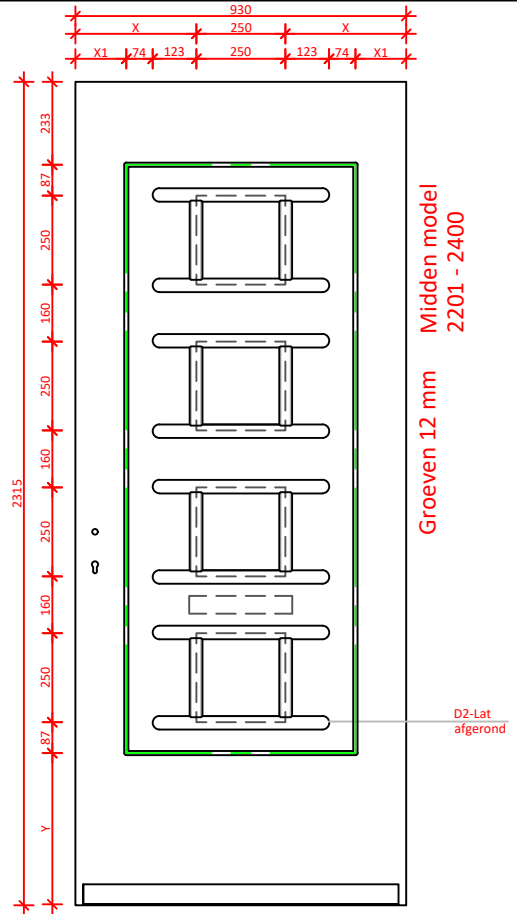
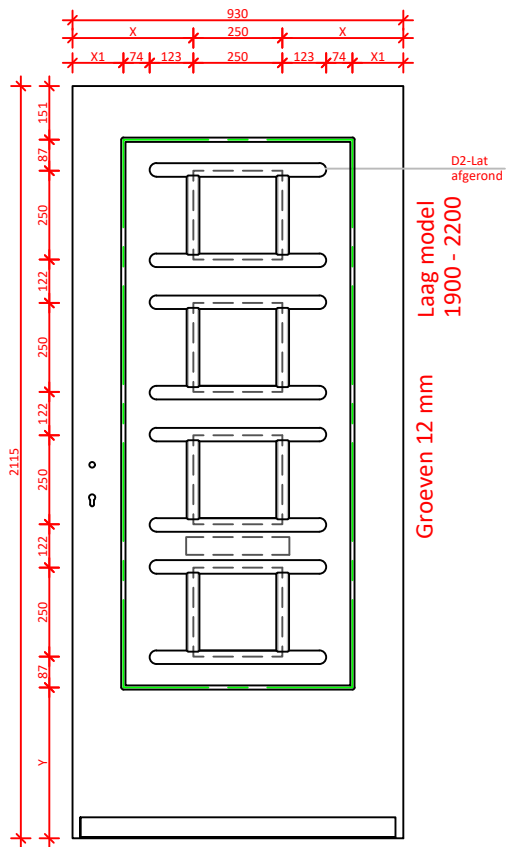

| | | | | | |
|--------|------------|---------------|-------------|-----------------|------------|
| DATUM: | GEWIJZIGD: | CALCULATIENR: | TEKENINGNR: | MODEL: 9467N | HOUTSOORT: |
|--------|------------|---------------|-------------|-----------------|------------|

| | | | | |
|------------------------------------------------------------------------------------|--------------------------------------------|--|--|-------------|
|  | KLANT/PROJECT: overzicht modellen 9467N | | | DCM NUMMER: |
|------------------------------------------------------------------------------------|--------------------------------------------|--|--|-------------|

| | | | | |
|-----------|---------|-----------------|------------|-----------|
| AANVRAAG: | SCHAAL: | GETEKEND: MN | LEVERWEEK: | 1.2a P.48 |
|-----------|---------|-----------------|------------|-----------|

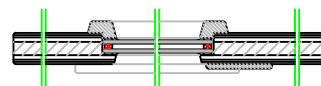
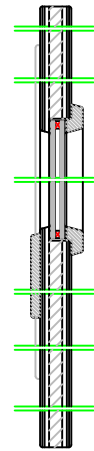
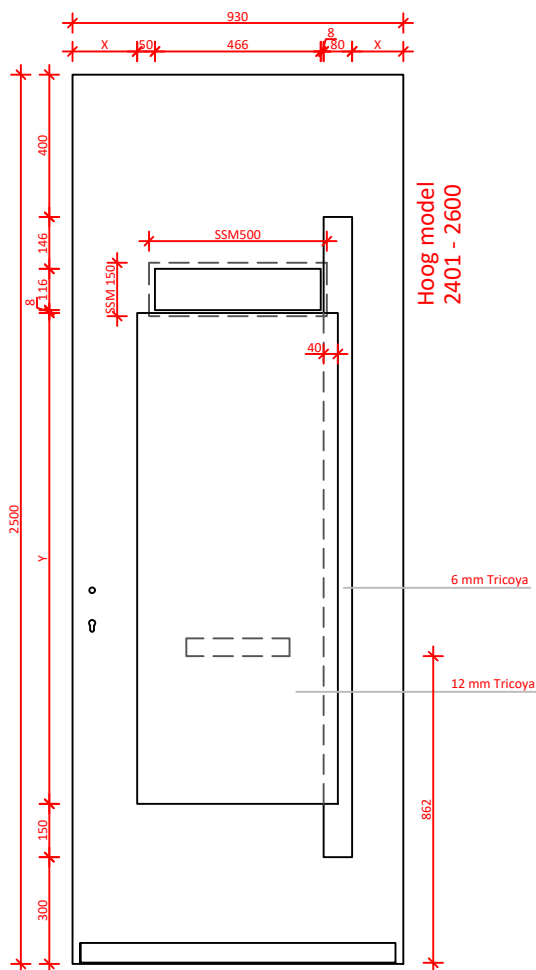
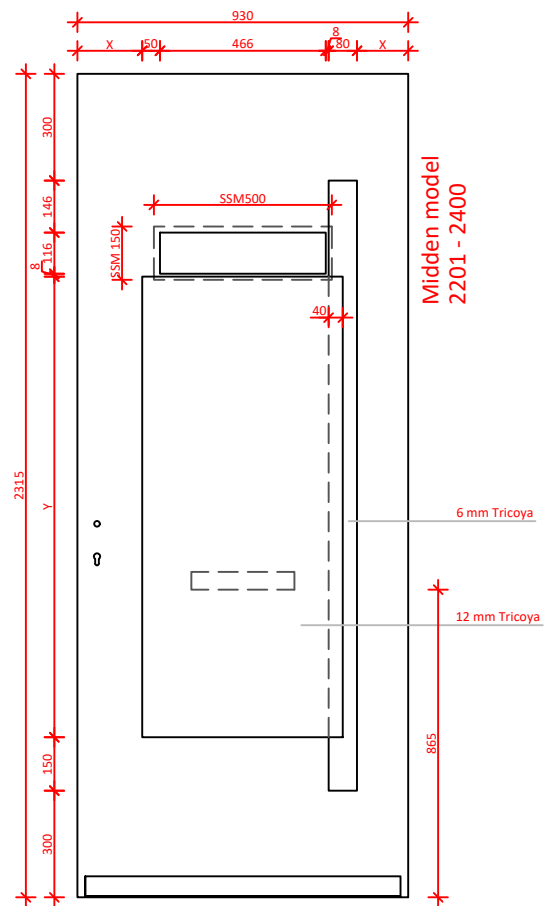
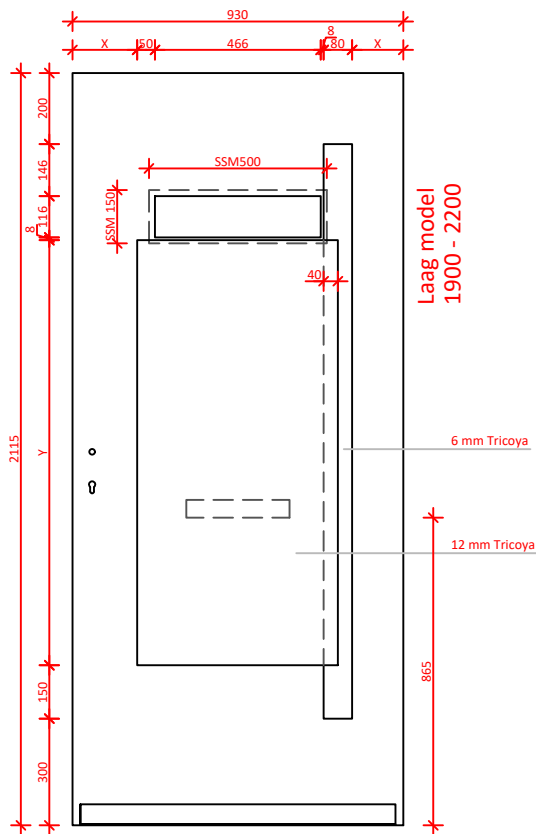

Strakke SponningMaat
 Pasmaat deurbreedte t/m 1000 mm : SSM 500mm
 Pasmaat deurbreedte 1001 t/m 1100 mm : SSM 600mm
 Pasmaat deurbreedte > 1101 mm : SSM 700mm

| | | | | | |
|--------|------------|---------------|-------------|-----------------|------------|
| DATUM: | GEWIJZIGD: | CALCULATIENR: | TEKENINGNR: | MODEL: 9501N | HOUTSOORT: |
|--------|------------|---------------|-------------|-----------------|------------|

| | | | | |
|-----------------------|-----------------------------------------------------------|--|--|-------------|
| KEGRO DEUREN | KLANT/PROJECT: overzicht modellen 9501N met briefsleuf | | | DCM NUMMER: |
|-----------------------|-----------------------------------------------------------|--|--|-------------|

| | | | | |
|-----------|---------|-----------------|------------|-----------|
| AANVRAAG: | SCHAAL: | GETEKEND: MN | LEVERWEEK: | 1.2a P.49 |
|-----------|---------|-----------------|------------|-----------|

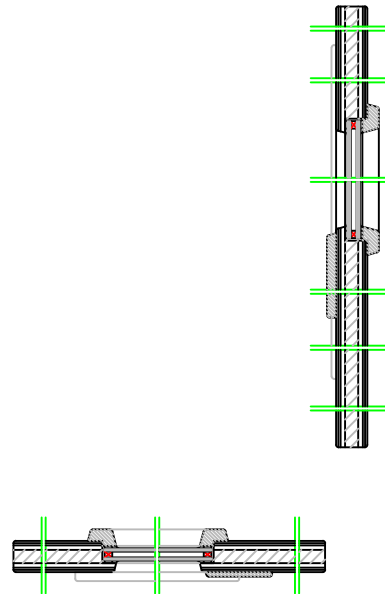
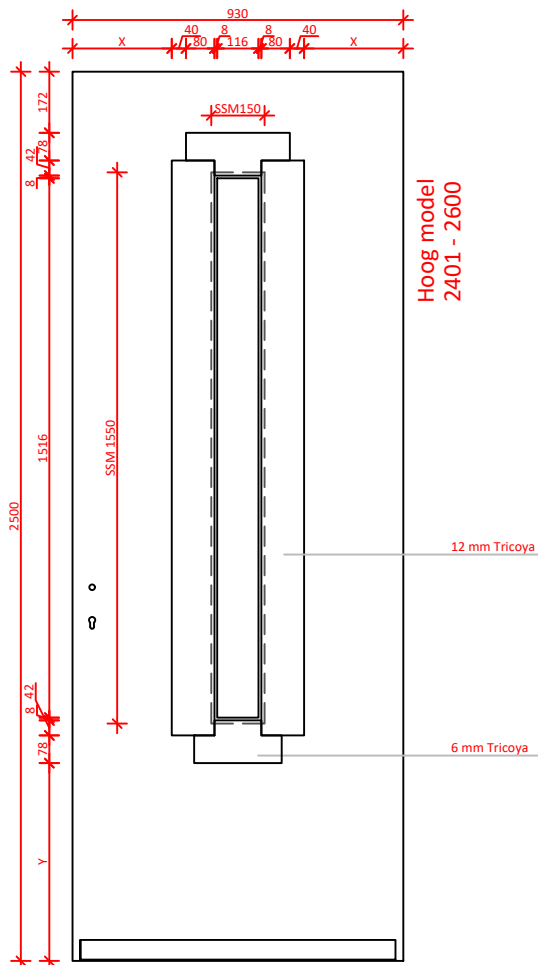
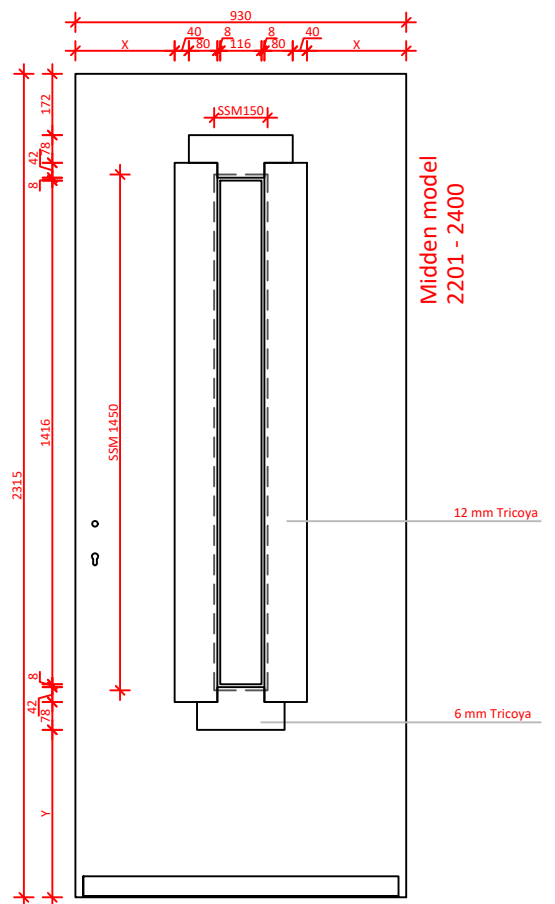
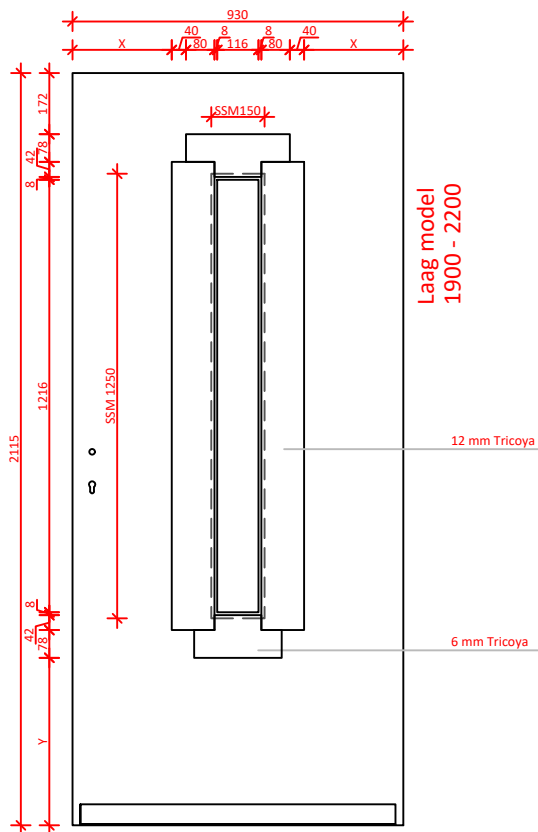

| | | | | | |
|--------|------------|---------------|-------------|-----------------|------------|
| DATUM: | GEWIJZIGD: | CALCULATIENR: | TEKENINGNR: | MODEL: 9502N | HOUTSOORT: |
|--------|------------|---------------|-------------|-----------------|------------|

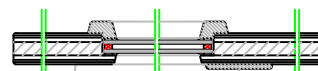
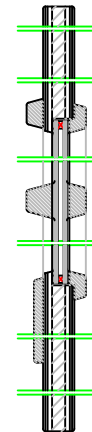
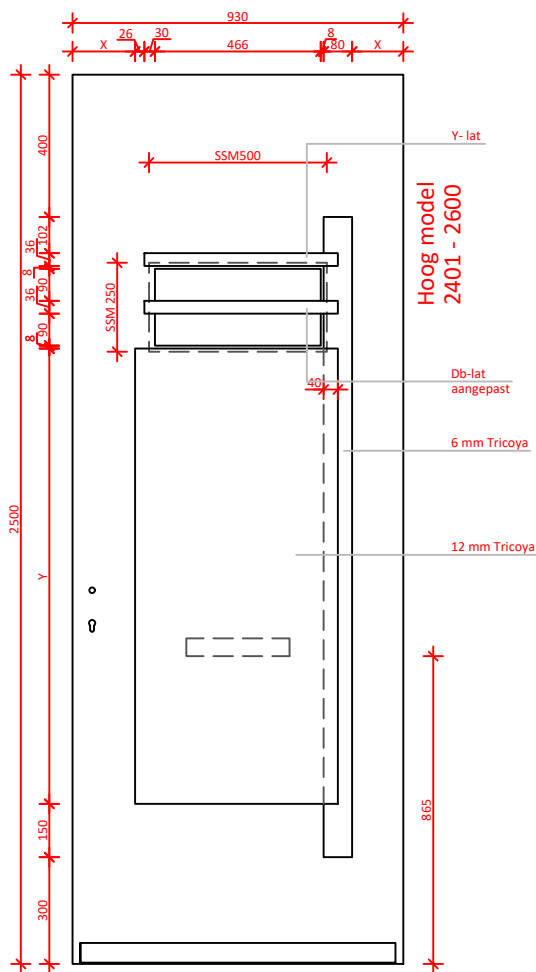
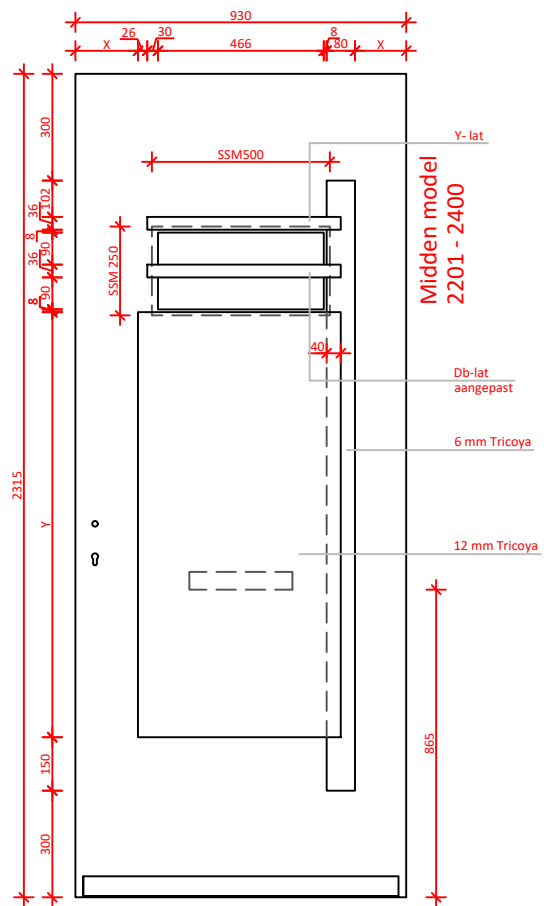
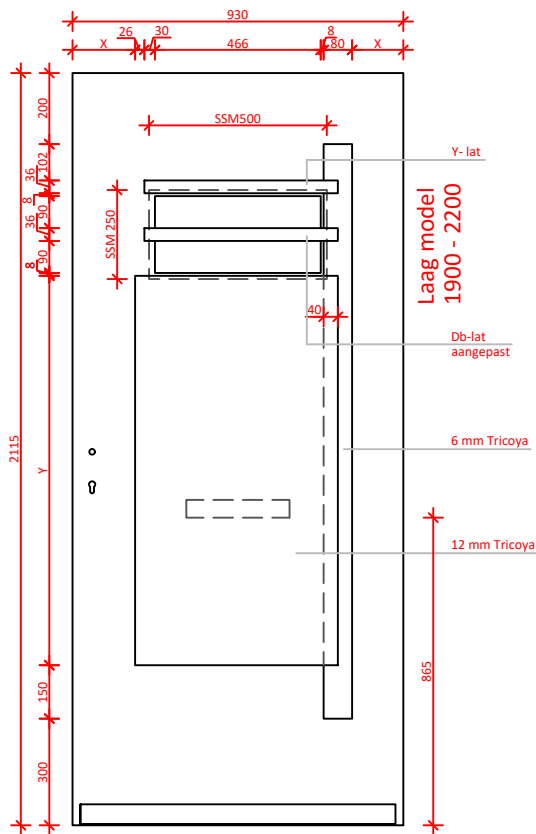

Strakke SponningMaat
 Pasmaat deurbreedte t/m 1000 mm : SSM 500mm
 Pasmaat deurbreedte 1001 t/m 1100 mm : SSM 600mm
 Pasmaat deurbreedte > 1101 mm : SSM 700mm

| | | | | | |
|--------|------------|---------------|-------------|-----------------|------------|
| DATUM: | GEWIJZIGD: | CALCULATIENR: | TEKENINGNR: | MODEL: 9503N | HOUTSOORT: |
|--------|------------|---------------|-------------|-----------------|------------|

| | | | | |
|--|-----------------------------------------------------------|--|--|-------------|
| | KLANT/PROJECT: overzicht modellen 9503N met briefsleuf | | | DCM NUMMER: |
|--|-----------------------------------------------------------|--|--|-------------|

| | | | | |
|-----------|---------|-----------------|------------|-----------|
| AANVRAAG: | SCHAAL: | GETEKEND: MN | LEVERWEEK: | 1.2a P.51 |
|-----------|---------|-----------------|------------|-----------|

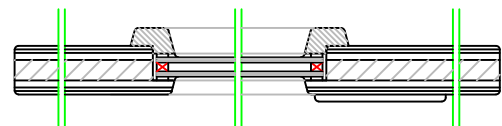
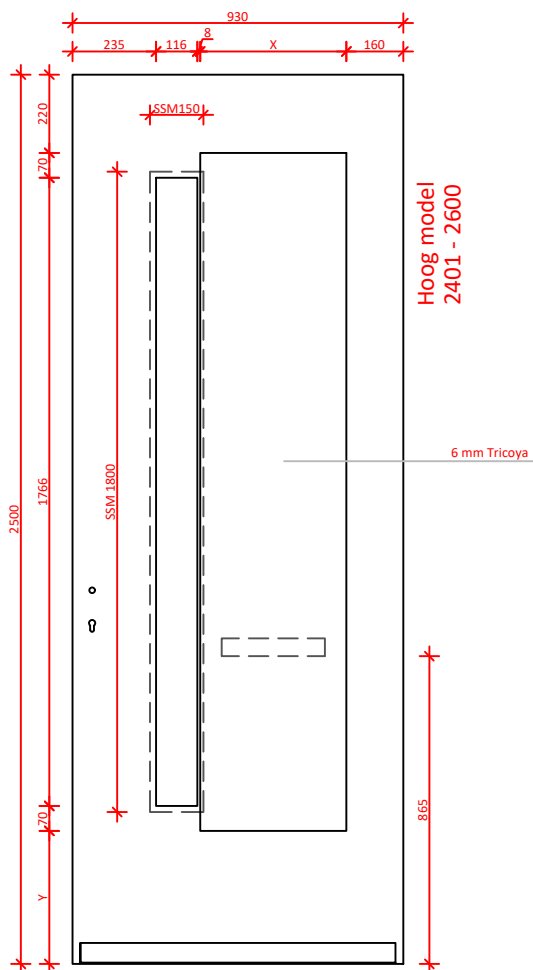
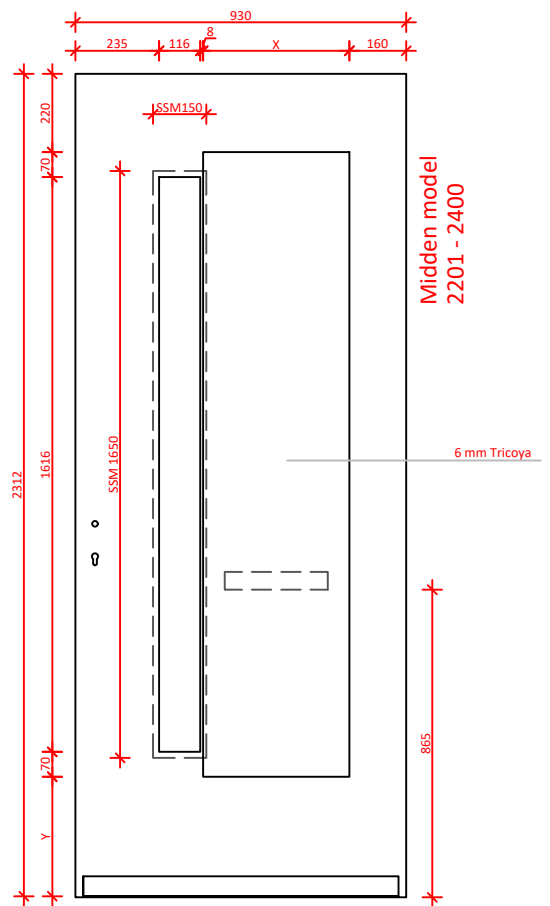
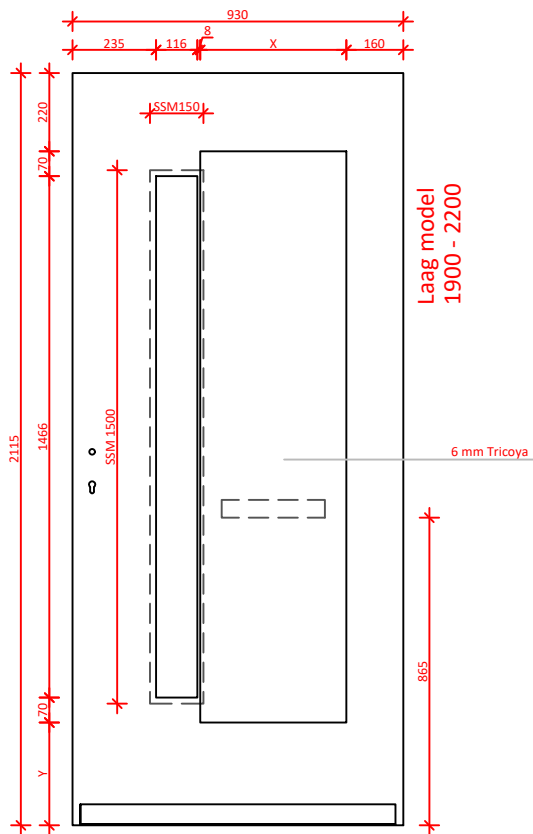

| | | | | | |
|--------|------------|---------------|-------------|-----------------|------------|
| DATUM: | GEWIJZIGD: | CALCULATIENR: | TEKENINGNR: | MODEL: 9504N | HOUTSOORT: |
|--------|------------|---------------|-------------|-----------------|------------|

| | | | | |
|--|----------------------------------------------------------|--|--|-------------|
| | KLANT/PROJECT: overzicht modellen 9504N met briefstuf | | | DCM NUMMER: |
|--|----------------------------------------------------------|--|--|-------------|

| | | | | |
|-----------|---------|-----------------|------------|-----------|
| AANVRAAG: | SCHAAL: | GETEKEND: MN | LEVERWEEK: | 1.2a P.52 |
|-----------|---------|-----------------|------------|-----------|

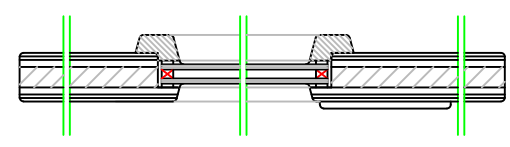
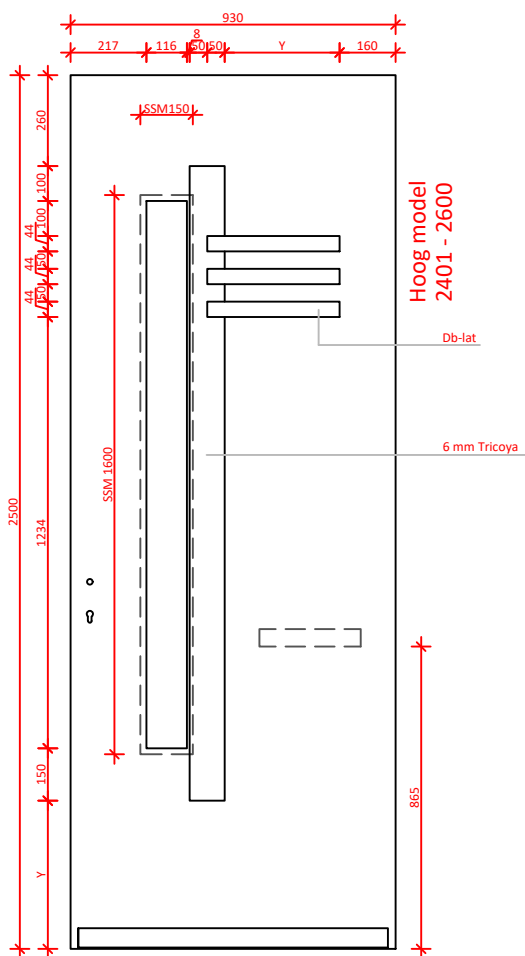
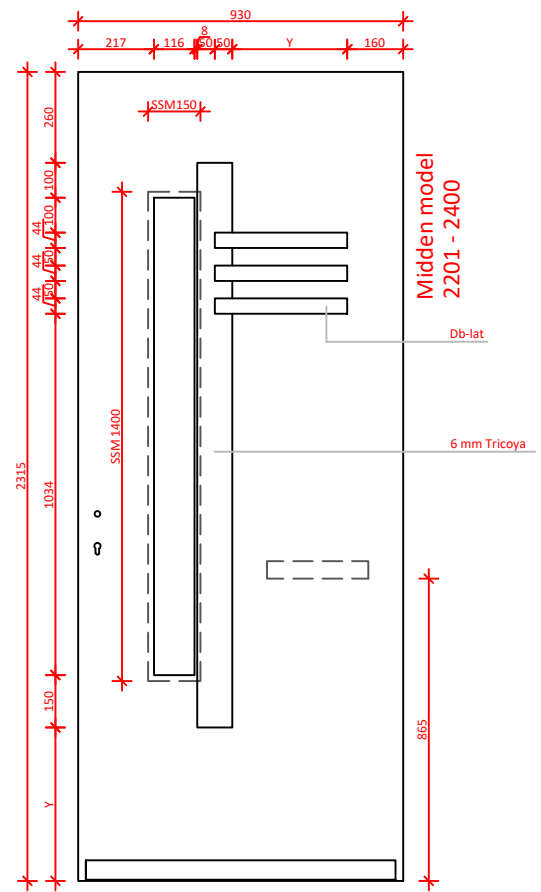
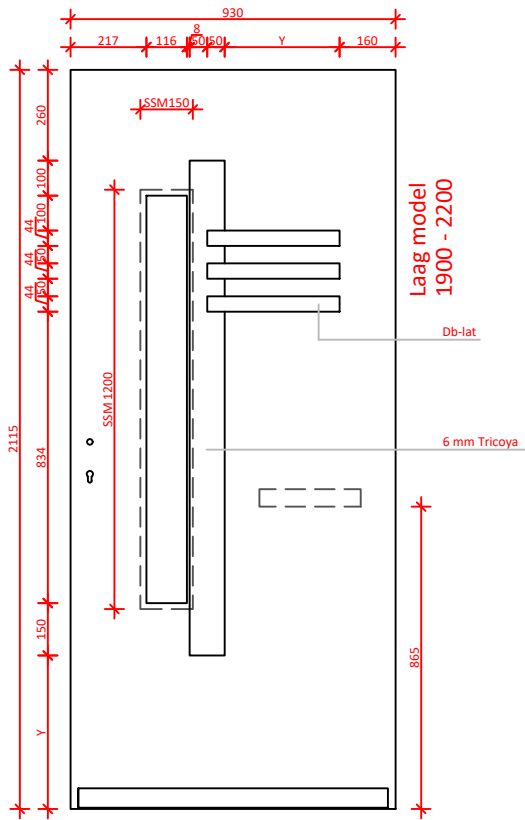

| | | | | | |
|--------|------------|---------------|-------------|-----------------|------------|
| DATUM: | GEWIJZIGD: | CALCULATIENR: | TEKENINGNR: | MODEL: 9505N | HOUTSOORT: |
|--------|------------|---------------|-------------|-----------------|------------|

| | | | | |
|--|--------------------------------------------|--|--|-------------|
| | KLANT/PROJECT: overzicht modellen 9505N | | | DCM NUMMER: |
|--|--------------------------------------------|--|--|-------------|

| | | | | |
|-----------|---------|-----------------|------------|-----------|
| AANVRAAG: | SCHAAL: | GETEKEND: MN | LEVERWEEK: | 1.2a P.53 |
|-----------|---------|-----------------|------------|-----------|

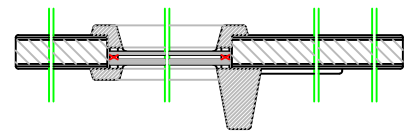
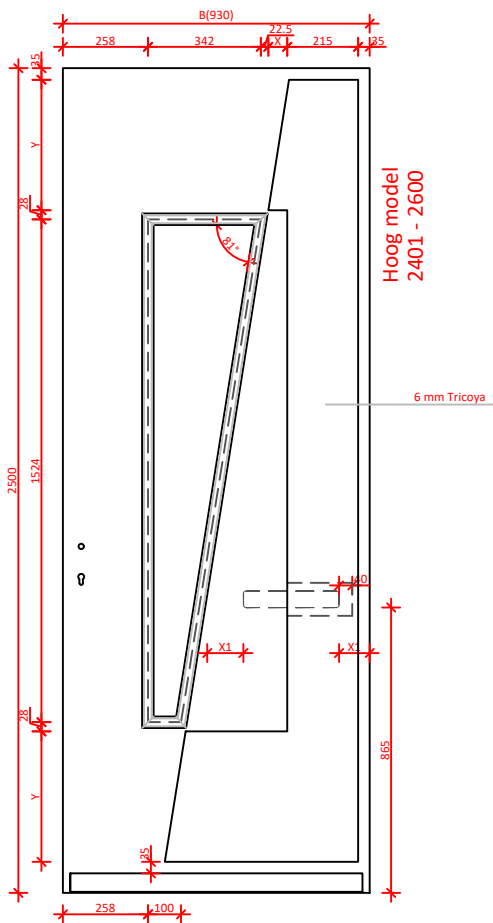
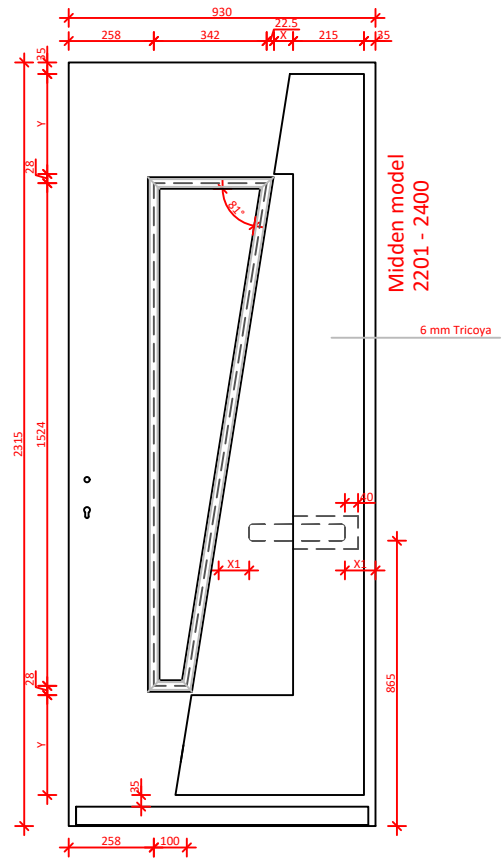
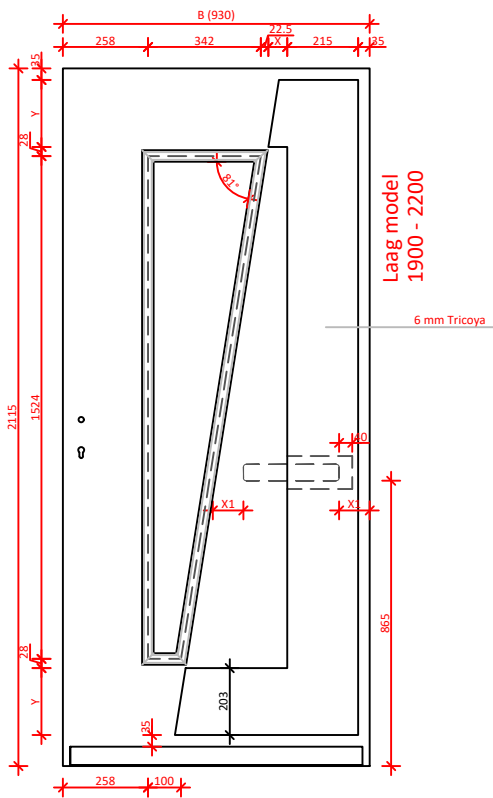

| | | | | | |
|--------|--------------------------|---------------|----------------------------------------------------|-----------------|-----------------|
| DATUM: | GEWIJZIGD: 21-04-2020 | CALCULATIENR: | TEKENINGNR: 9536N | MODEL: 9536N | HOUTSOORT: |
| | | | KLANT/PROJECT: overzicht modellen 9536N L1 - R4 | | DCM NUMMER: |
| | | | AANVRAAG: | SCHAAL: | GETEKEND: MN |

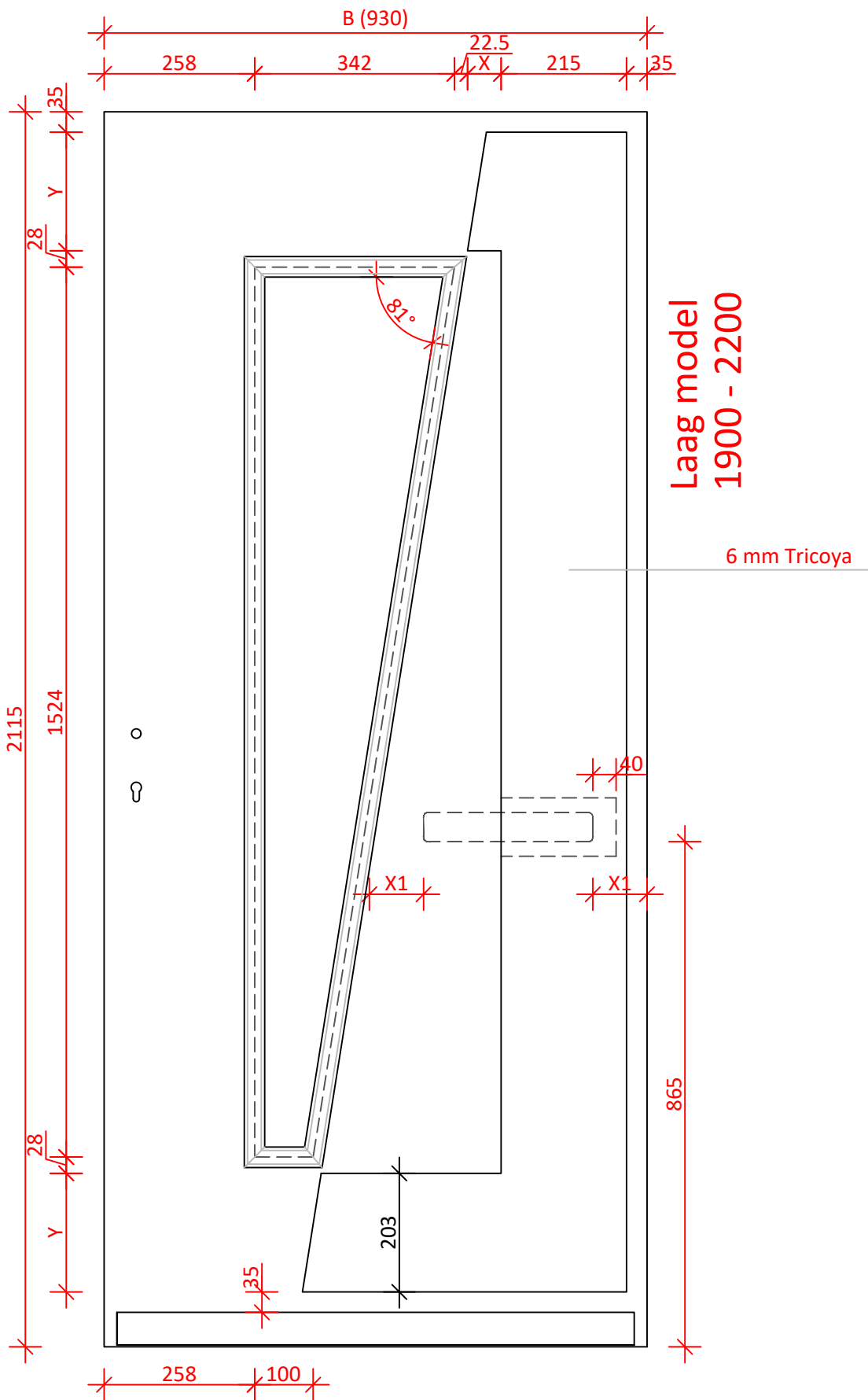

| | | | | | |
|------------------------------------------------------------------------------------|--------------------------|---------------|-------------------------------------------|-----------------|-----------------|
| DATUM: | GEWIJZIGD: 21-04-2020 | CALCULATIENR: | TEKENINGNR: 9536N | MODEL: 9536N | HOUTSOORT: |
|  | | | KLANT/PROJECT: 9536N Laag model L1 -R4 | | DCM NUMMER: |
| | | | AANVRAAG: | SCHAAL: | GETEKEND: MN |

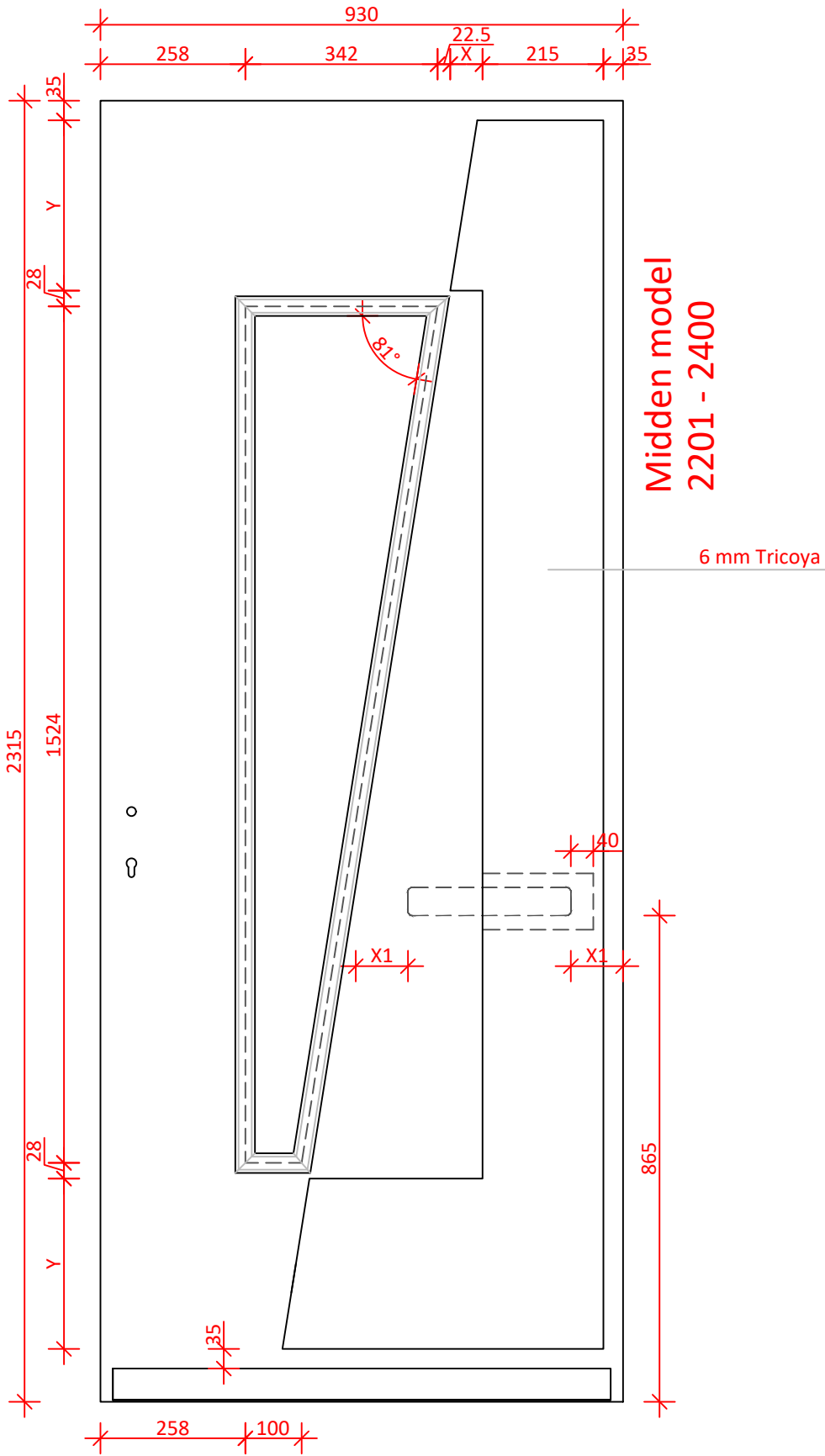

| | | | | | |
|------------------------------------------------------------------------------------|--------------------------|---------------|----------------------------------------------|-----------------|-----------------|
| DATUM: | GEWIJZIGD: 21-04-2020 | CALCULATIENR: | TEKENINGNR: 9536N | MODEL: 9536N | HOUTSOORT: |
|  | | | KLANT/PROJECT: 9536N Midden model L1 - R4 | | DCM NUMMER: |
| | | | AANVRAAG: | SCHAAL: | GETEKEND: MN |

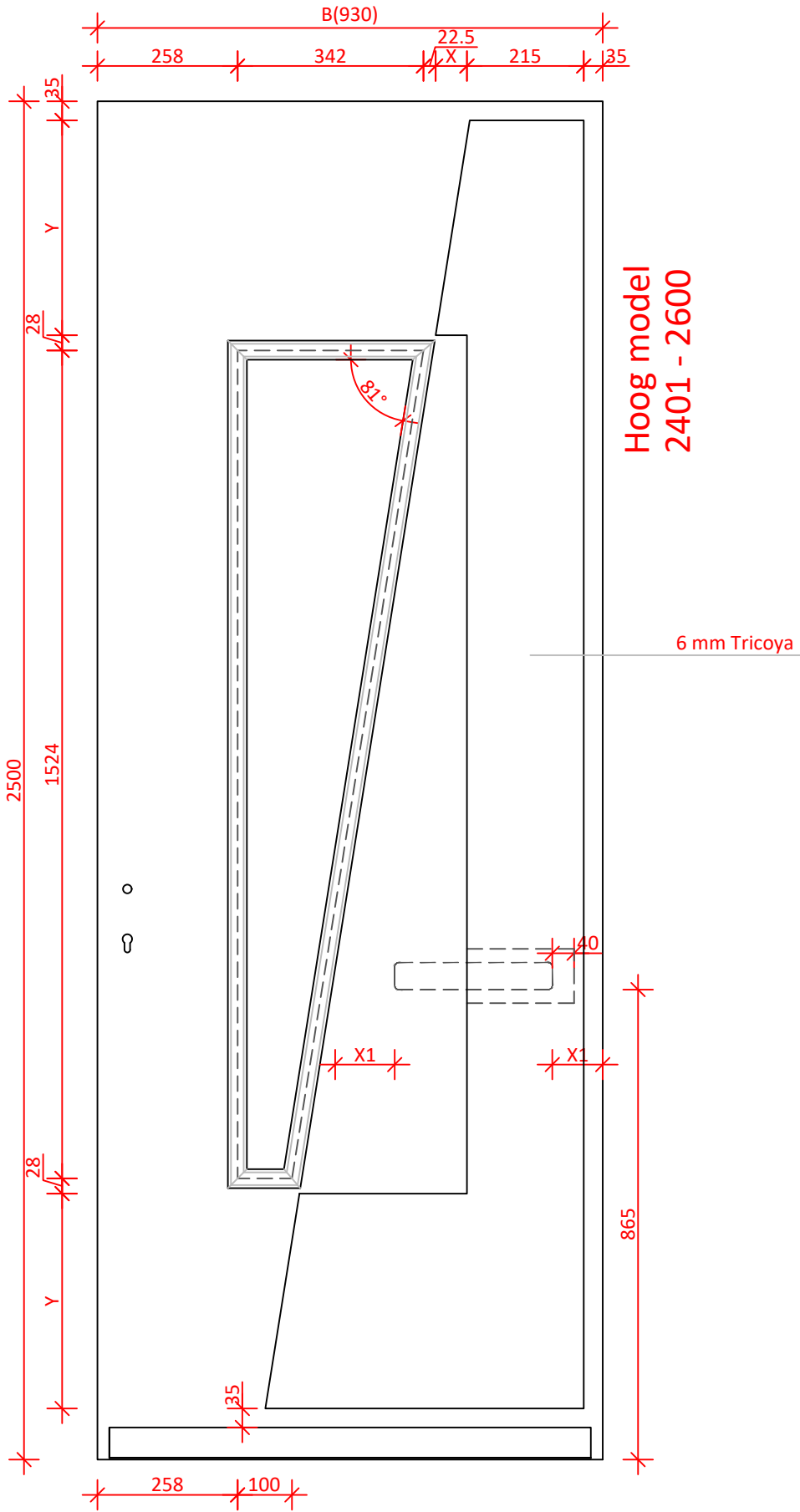

| | | | | | |
|------------------------------------------------------------------------------------|--------------------------|---------------|--------------------------------------------|-----------------|-----------------|
| DATUM: | GEWIJZIGD: 21-04-2020 | CALCULATIENR: | TEKENINGNR: 9536N | MODEL: 9536N | HOUTSOORT: |
|  | | | KLANT/PROJECT: 9536N Hoog model L1 - R4 | | DCM NUMMER: |
| | | | AANVRAAG: | SCHAAL: | GETEKEND: MN |

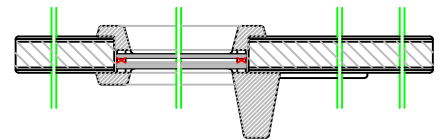
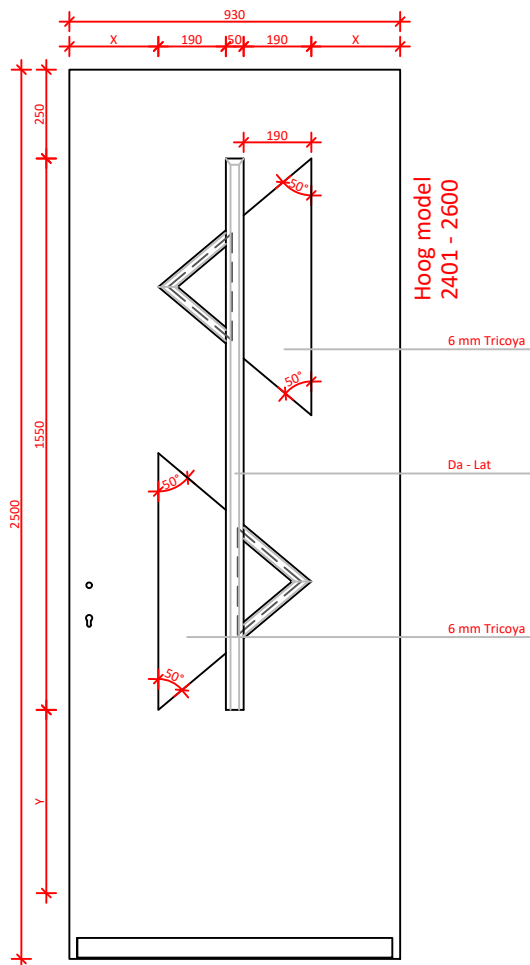
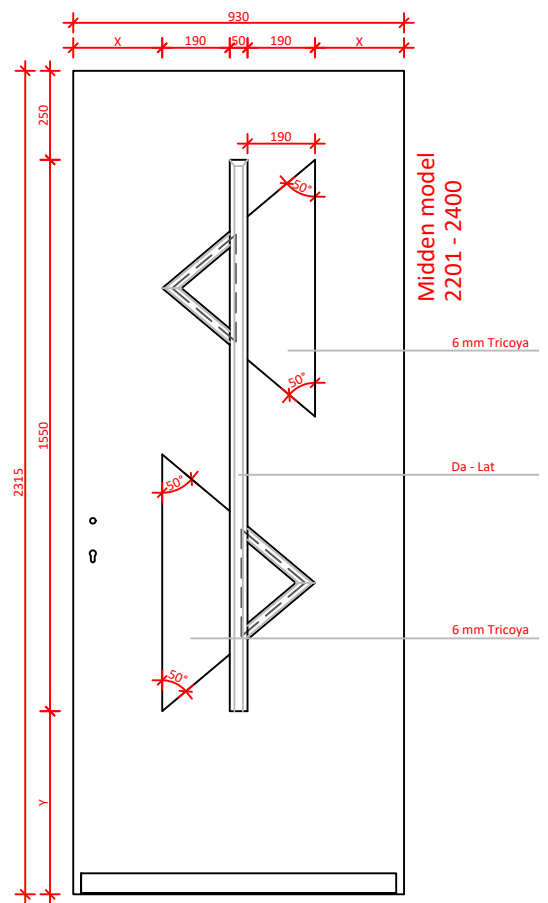
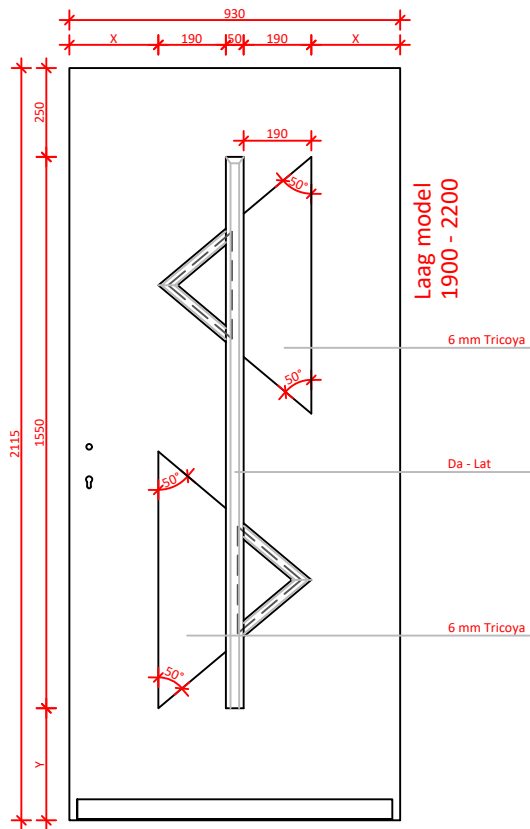

| | | | | | |
|--------|------------|---------------|-------------|----------------|------------|
| DATUM: | GEWIJZIGD: | CALCULATIENR: | TEKENINGNR: | MODEL: 9538 | HOUTSOORT: |
|--------|------------|---------------|-------------|----------------|------------|

| | | | | |
|--|---------------------------------------------------|--|--|-------------|
| | KLANT/PROJECT: overzicht modellen 9538 L1 - R4 | | | DCM NUMMER: |
|--|---------------------------------------------------|--|--|-------------|

| | | | | |
|-----------|---------|-----------------|------------|-----------|
| AANVRAAG: | SCHAAL: | GETEKEND: MN | LEVERWEEK: | 1.2a P.58 |
|-----------|---------|-----------------|------------|-----------|

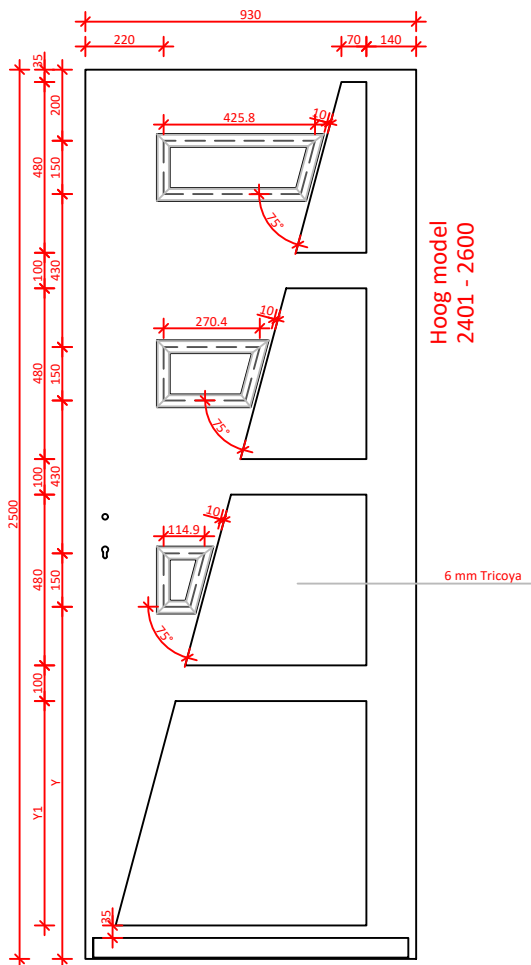
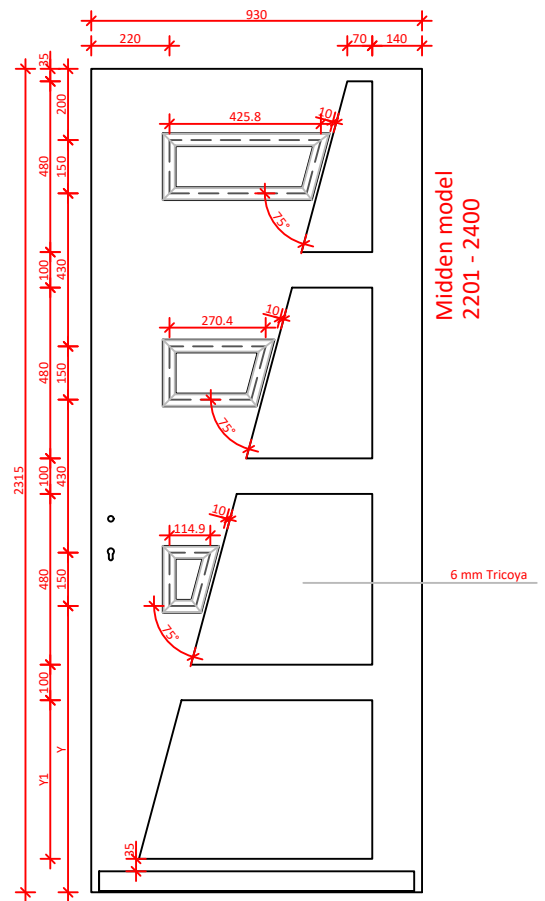
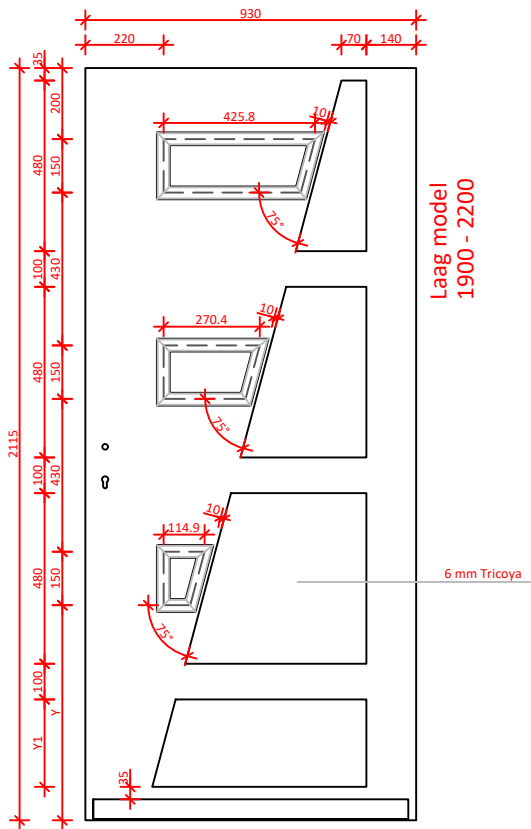

| | | | | | |
|--------|------------|---------------|-------------|-----------------|------------|
| DATUM: | GEWIJZIGD: | CALCULATIENR: | TEKENINGNR: | MODEL: 9548N | HOUTSOORT: |
|--------|------------|---------------|-------------|-----------------|------------|

| | | | | |
|--|----------------------------------------------------|--|--|-------------|
| | KLANT/PROJECT: overzicht modellen 9548N L1 - R4 | | | DCM NUMMER: |
|--|----------------------------------------------------|--|--|-------------|

| | | | | |
|-----------|---------|-----------------|------------|-----------|
| AANVRAAG: | SCHAAL: | GETEKEND: MN | LEVERWEEK: | 1.2a P.59 |
|-----------|---------|-----------------|------------|-----------|

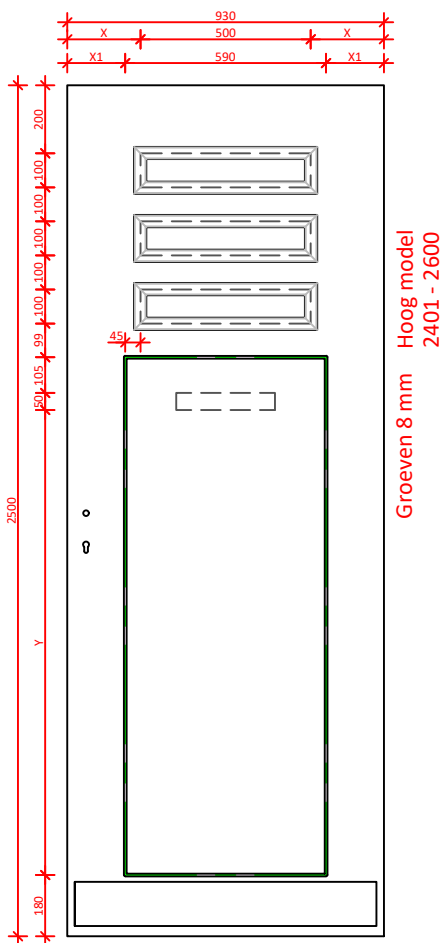
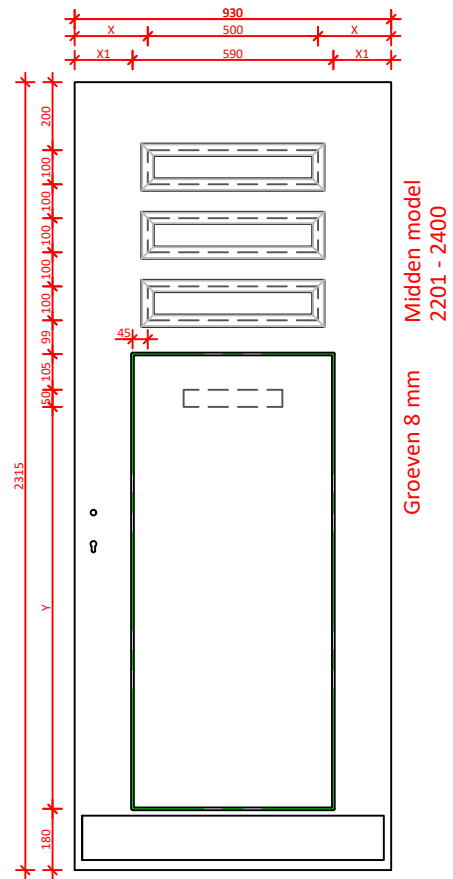
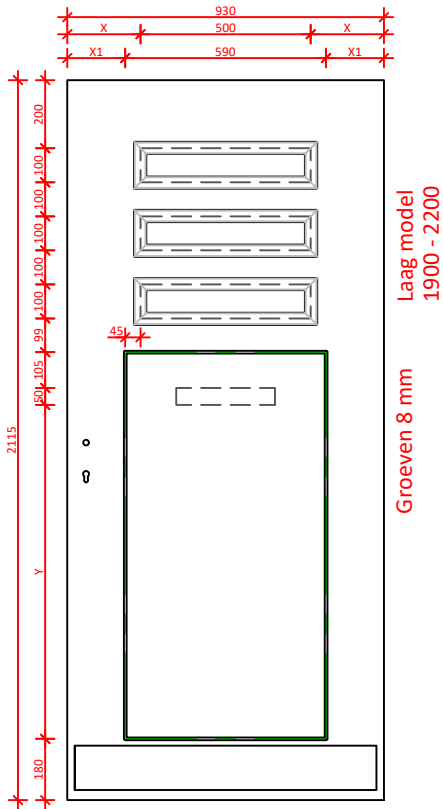

| | | | | | |
|--------|------------|---------------|----------------------|-----------------|------------|
| DATUM: | GEWIJZIGD: | CALCULATIENR: | TEKENINGNR: 9578N | MODEL: 9578N | HOUTSOORT: |
|--------|------------|---------------|----------------------|-----------------|------------|

| | | | | | |
|-----------------------|--------------------------------------------|--|--|-------------|--|
| KEGRO DEUREN | KLANT/PROJECT: overzicht modellen 9578N | | | DCM NUMMER: | |
|-----------------------|--------------------------------------------|--|--|-------------|--|

| | | | | |
|-----------|---------|-----------------|------------|-----------|
| AANVRAAG: | SCHAAL: | GETEKEND: MN | LEVERWEEK: | 1.2a P.60 |
|-----------|---------|-----------------|------------|-----------|

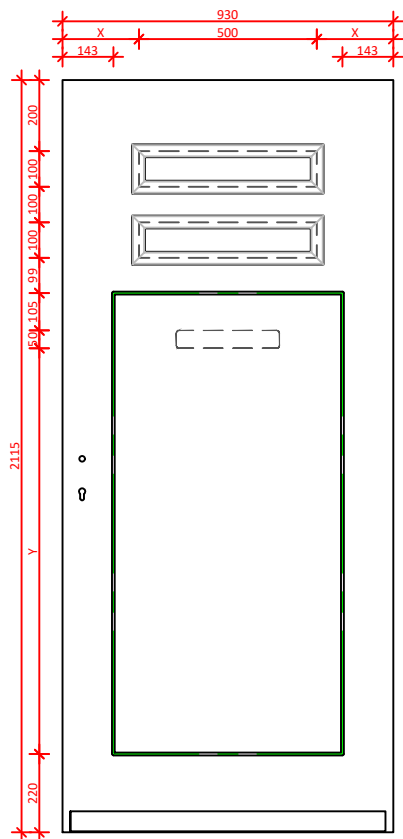

Laag model
1900 - 2200

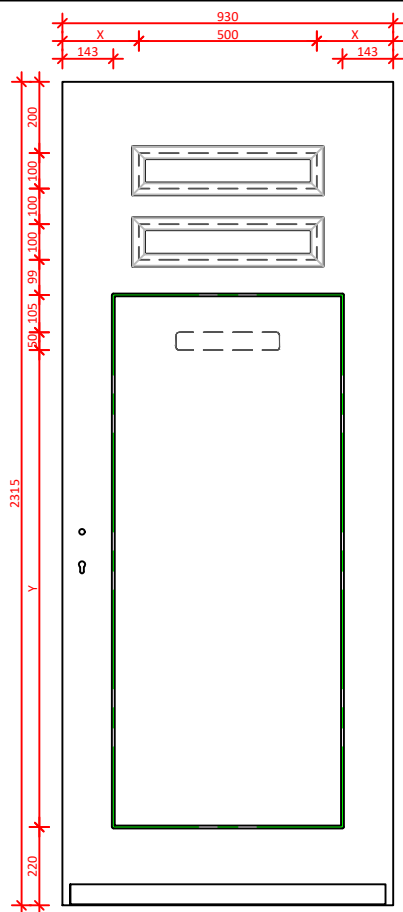

Midden model
2201 - 2400

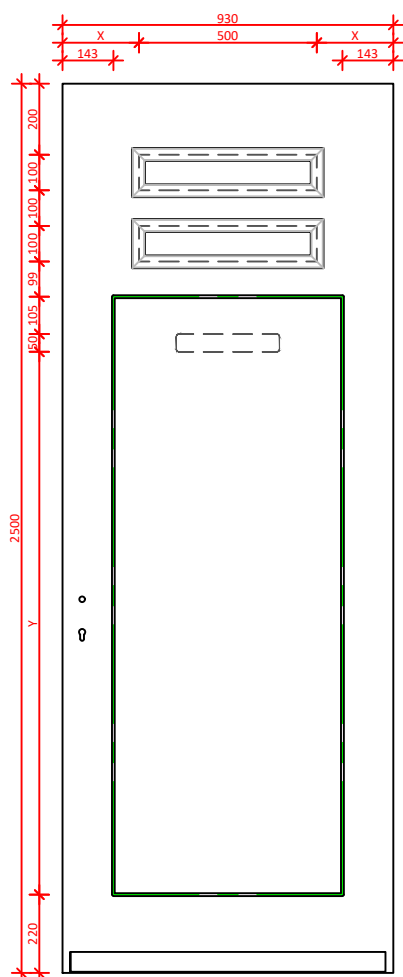

Hoog model
2401 - 2600

Strakke SponningMaat

- Pasmaat deurbreedte t/m 1000 mm : SSM 500mm
- Pasmaat deurbreedte 1001 t/m 1100 mm : SSM 600mm
- Pasmaat deurbreedte > 1101 mm : SSM 700mm

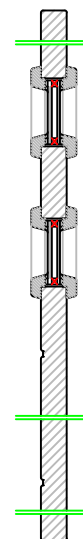

| | | | | | |
|--------|------------|---------------|----------------------|-----------------|------------|
| DATUM: | GEWIJZIGD: | CALCULATIENR: | TEKENINGNR: 9579N | MODEL: 9579N | HOUTSOORT: |
|--------|------------|---------------|----------------------|-----------------|------------|

| | | | | |
|------------------------------------------------------------------------------------|--------------------------------------------|--|--|-------------|
|  | KLANT/PROJECT: overzicht modellen 9579N | | | DCM NUMMER: |
|------------------------------------------------------------------------------------|--------------------------------------------|--|--|-------------|

| | | | | |
|-----------|---------|-----------------|------------|-----------|
| AANVRAAG: | SCHAAL: | GETEKEND: MN | LEVERWEEK: | 1.2a P.61 |
|-----------|---------|-----------------|------------|-----------|

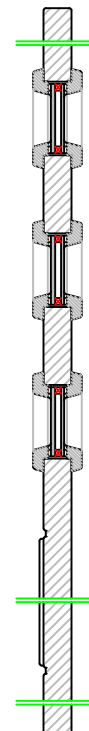
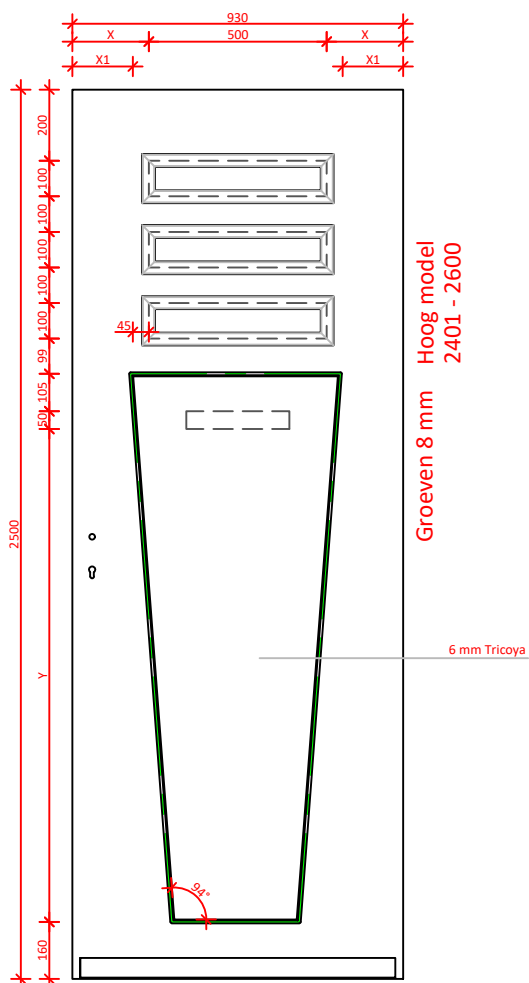
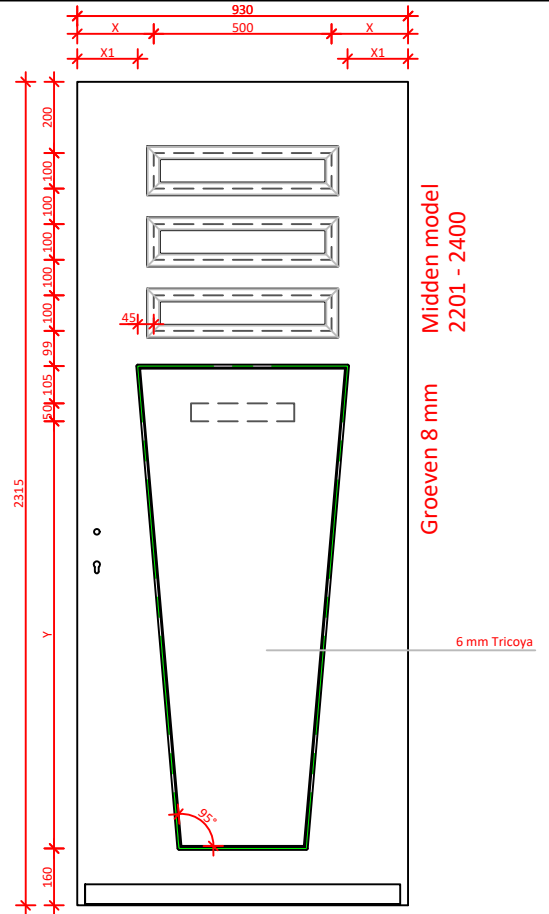
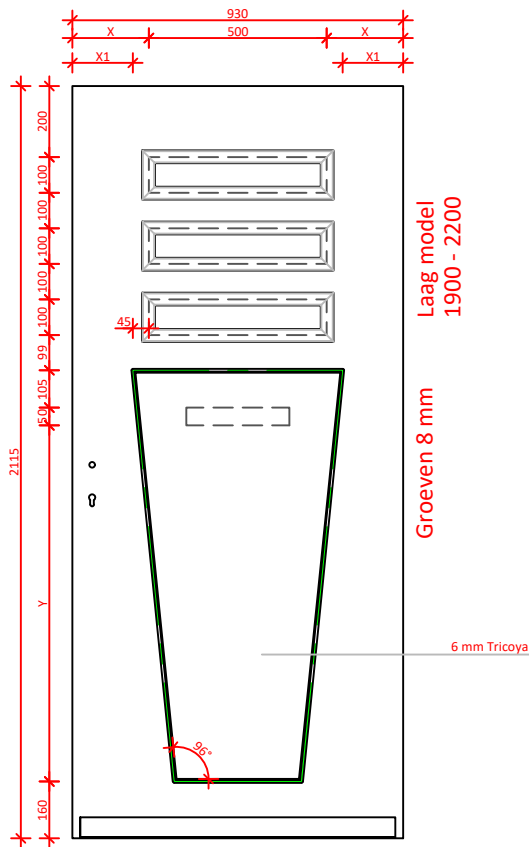

Strakke SponningMaat

- Pasmaat deurbreedte t/m 1000 mm : SSM 500mm
- Pasmaat deurbreedte 1001 t/m 1100 mm : SSM 600mm
- Pasmaat deurbreedte > 1101 mm : SSM 700mm

| | | | | | |
|--------|------------|---------------|-------------|-----------------|------------|
| DATUM: | GEWIJZIGD: | CALCULATIENR: | TEKENINGNR: | MODEL: 9580N | HOUTSOORT: |
|--------|------------|---------------|-------------|-----------------|------------|

| | | | | |
|-----------------------|--------------------------------------------|--|--|-------------|
| KEGRO DEUREN | KLANT/PROJECT: overzicht modellen 9580N | | | DCM NUMMER: |
|-----------------------|--------------------------------------------|--|--|-------------|

| | | | | |
|-----------|---------|-----------------|------------|-----------|
| AANVRAAG: | SCHAAL: | GETEKEND: MN | LEVERWEEK: | 1.2a P.62 |
|-----------|---------|-----------------|------------|-----------|

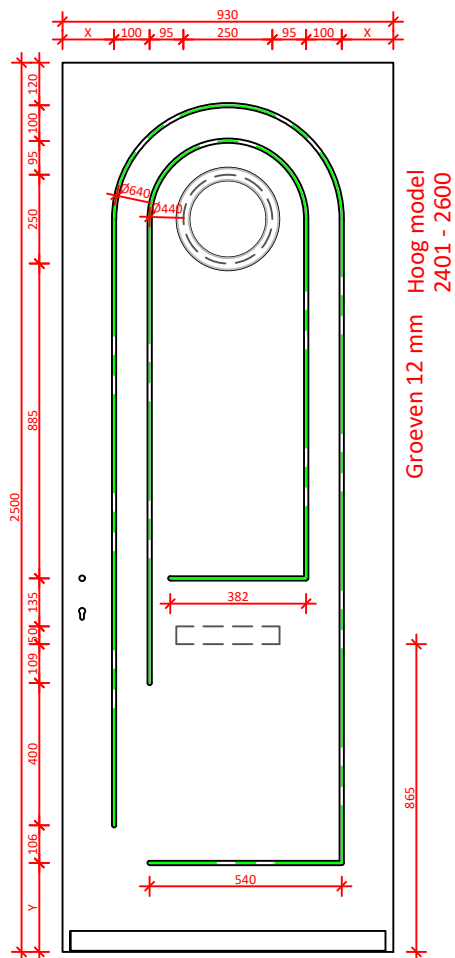
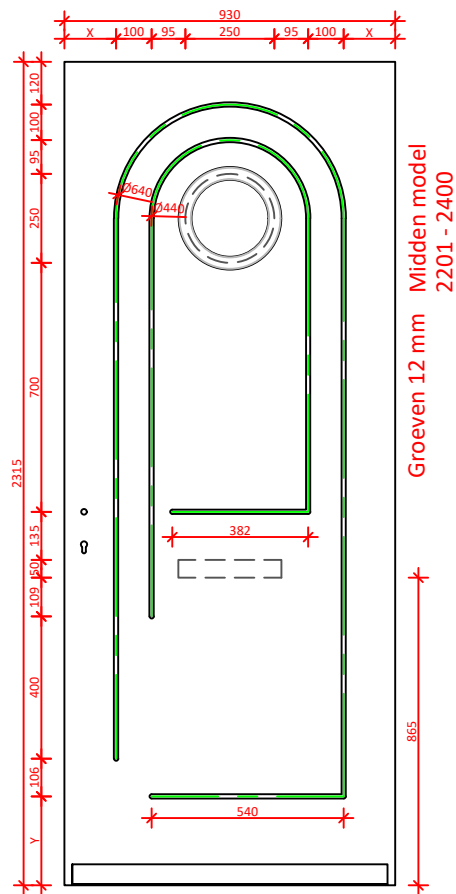
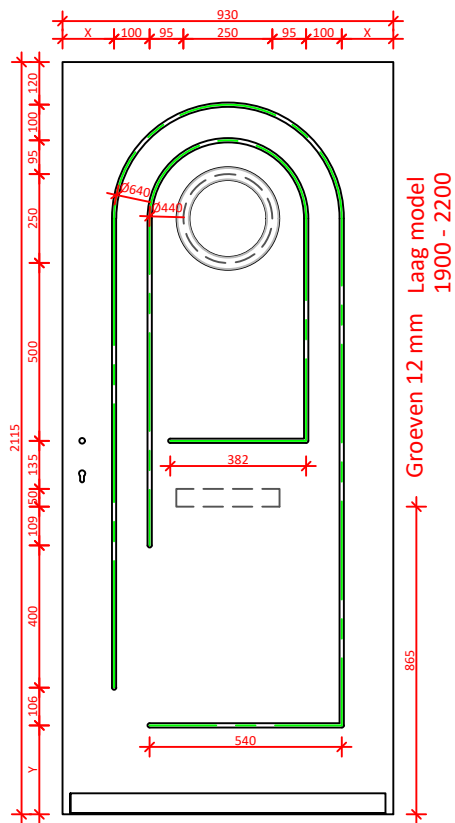

| | | | | | |
|--------|------------|---------------|-------------|----------------|------------|
| DATUM: | GEWIJZIGD: | CALCULATIENR: | TEKENINGNR: | MODEL: 9726 | HOUTSOORT: |
|--------|------------|---------------|-------------|----------------|------------|

| | | | | |
|--|---------------------------------------------------|--|--|-------------|
| | KLANT/PROJECT: overzicht modellen 9726 L1 - R4 | | | DCM NUMMER: |
|--|---------------------------------------------------|--|--|-------------|

| | | | |
|-----------|---------|-----------------|-------------------------|
| AANVRAAG: | SCHAAL: | GETEKEND: MN | LEVERWEEK: 1.2a P.63 |
|-----------|---------|-----------------|-------------------------|

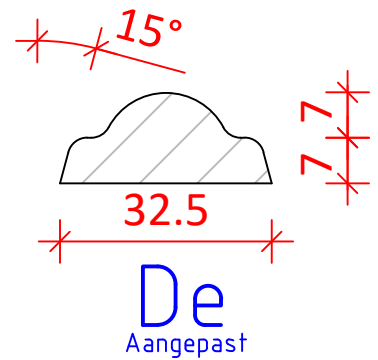
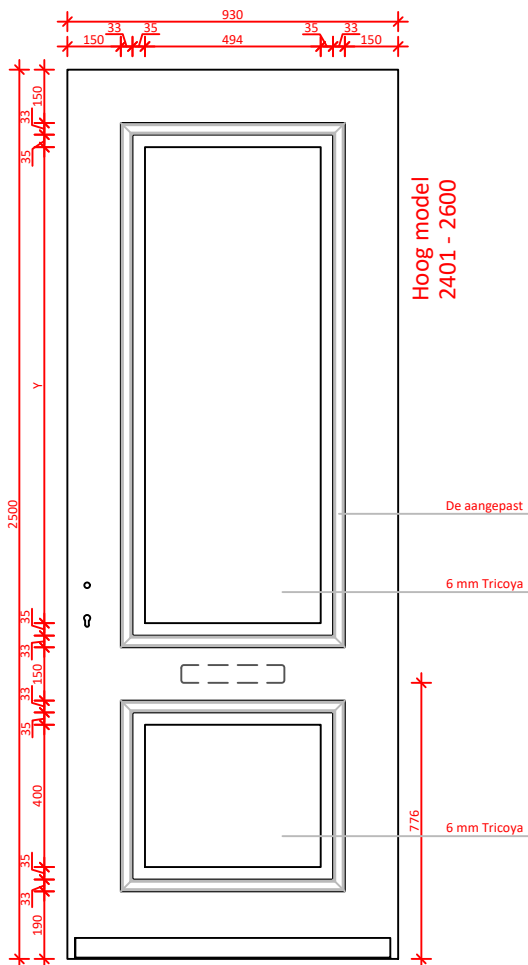
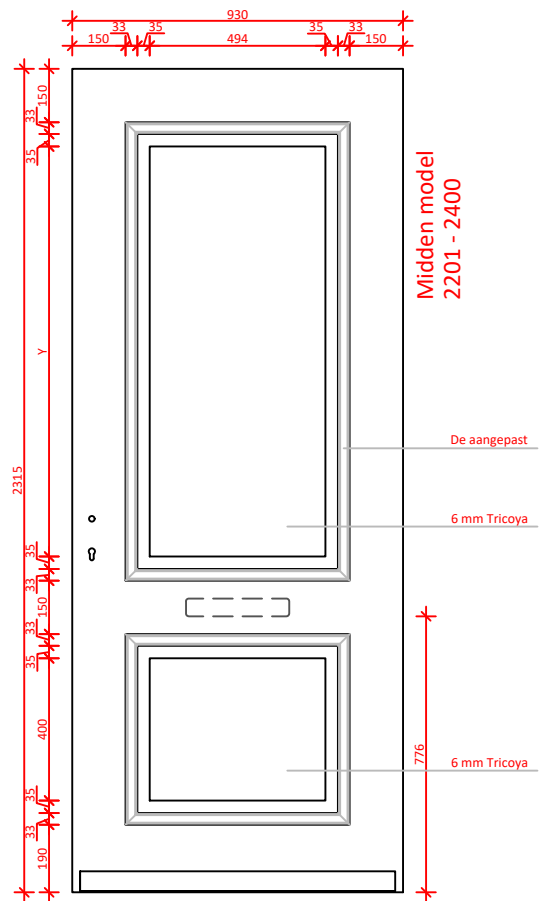
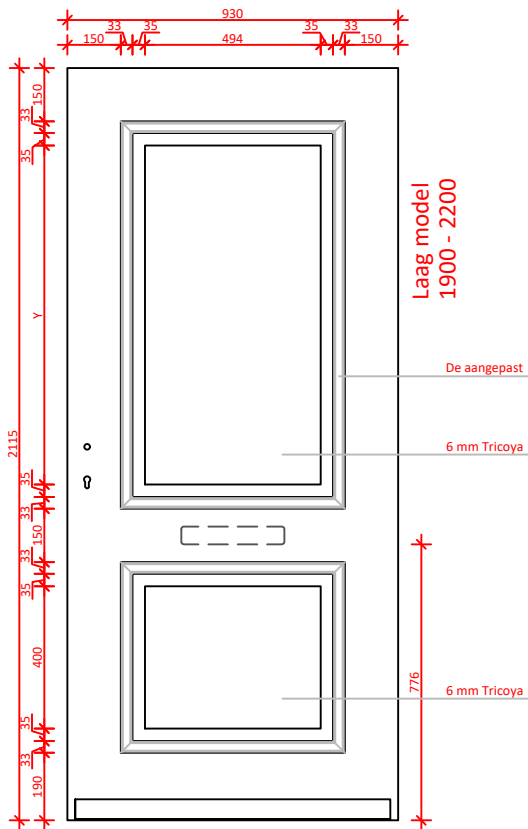

| | | | | | |
|--------|------------|---------------|-------------|----------------|------------|
| DATUM: | GEWIJZIGD: | CALCULATIENR: | TEKENINGNR: | MODEL: 9750 | HOUTSOORT: |
|--------|------------|---------------|-------------|----------------|------------|

| | | | | |
|--|-------------------------------------------|--|--|-------------|
| | KLANT/PROJECT: overzicht modellen 9750 | | | DCM NUMMER: |
|--|-------------------------------------------|--|--|-------------|

| | | | | |
|-----------|---------|-----------------|------------|-----------|
| AANVRAAG: | SCHAAL: | GETEKEND: MN | LEVERWEEK: | 1.2a P.64 |
|-----------|---------|-----------------|------------|-----------|

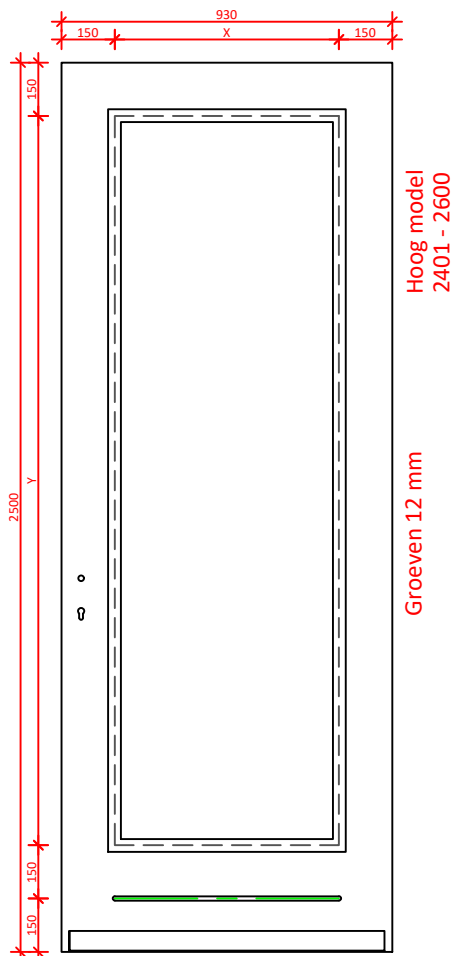
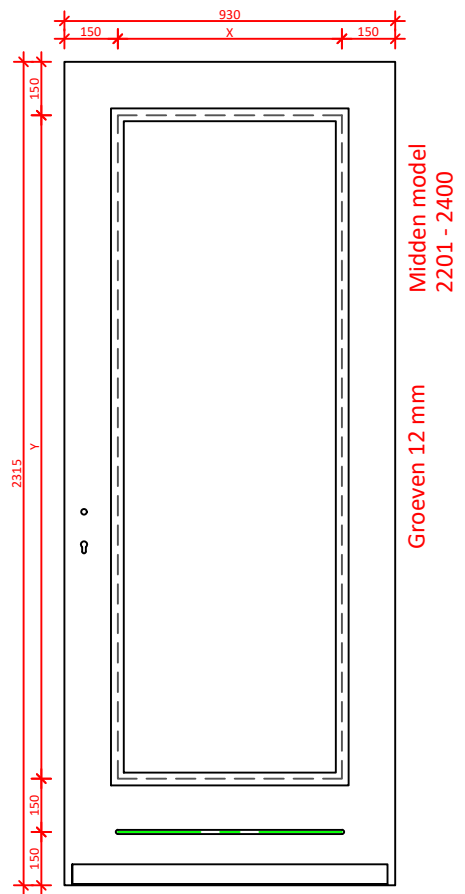
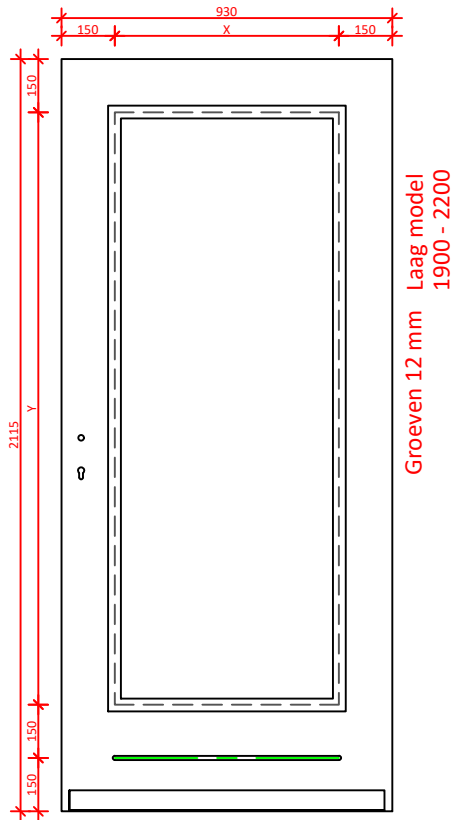

Alleen in KegaPro+ 74 mm.

| | | | | | |
|--------|------------|---------------|---------------------|----------------|------------|
| DATUM: | GEWIJZIGD: | CALCULATIENR: | TEKENINGNR: 9768 | MODEL: 9768 | HOUTSOORT: |
|--------|------------|---------------|---------------------|----------------|------------|

| | | | | |
|--|---------------------------------------------------|--|--|-------------|
| | KLANT/PROJECT: overzicht modellen 9768 L1 - R4 | | | DCM NUMMER: |
|--|---------------------------------------------------|--|--|-------------|

| | | | | |
|-----------|---------|-----------|------------|-----------|
| AANVRAAG: | SCHAAL: | GETEKEND: | LEVERWEEK: | 1.2a P.65 |
|-----------|---------|-----------|------------|-----------|

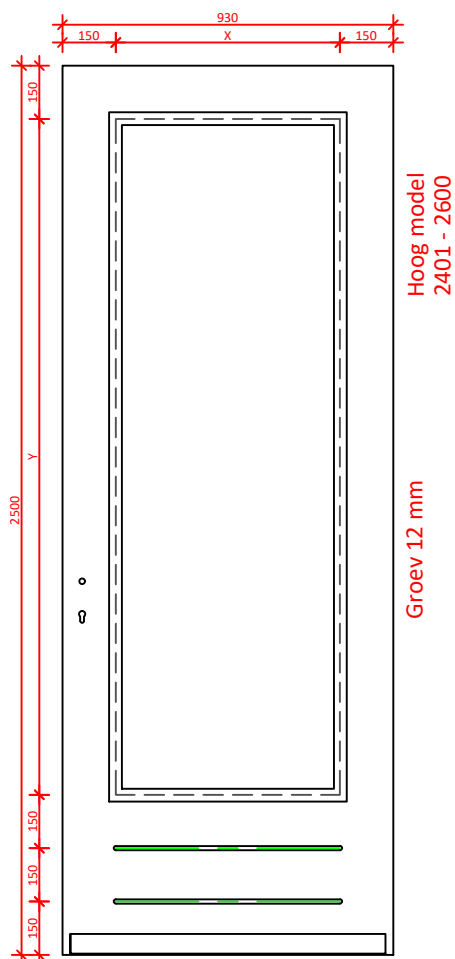
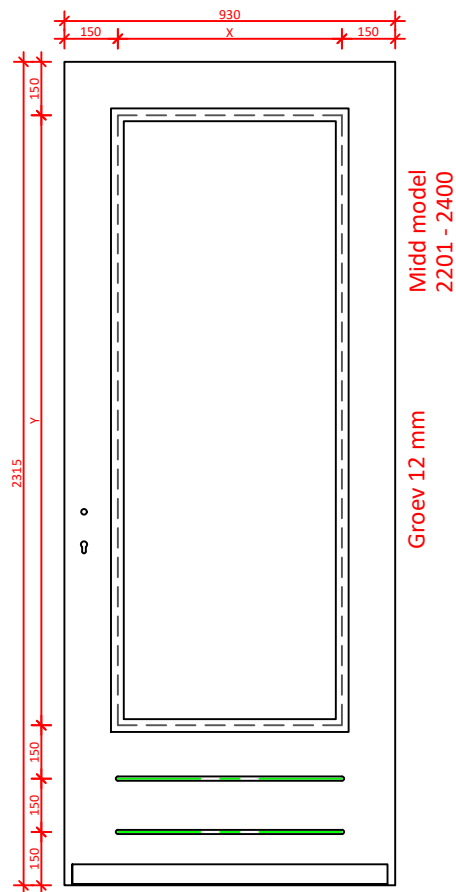
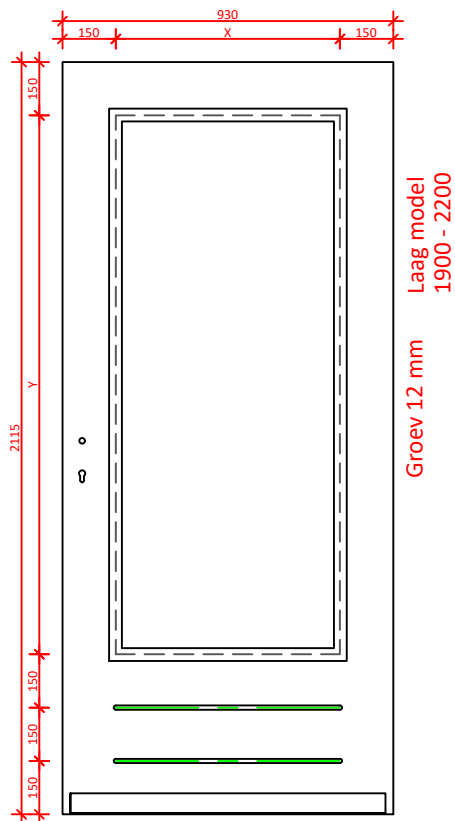

Alleen in KegaPro 74 mm .

| | | | | | |
|--------|------------|---------------|---------------------|----------------|------------|
| DATUM: | GEWIJZIGD: | CALCULATIENR: | TEKENINGNR: 9769 | MODEL: 9769 | HOUTSOORT: |
|--------|------------|---------------|---------------------|----------------|------------|

| | | | | |
|-----------------------|-------------------------------------------------|--|--|-------------|
| KEGRO DEUREN | KLANT/PROJECT: overzicht modell 9769 L1 - R4 | | | DCM NUMMER: |
|-----------------------|-------------------------------------------------|--|--|-------------|

| | | | | |
|-----------|---------|-----------|------------|-----------|
| AANVRAAG: | SCHAAL: | GETEKEND: | LEVERWEEK: | 1.2a P.66 |
|-----------|---------|-----------|------------|-----------|

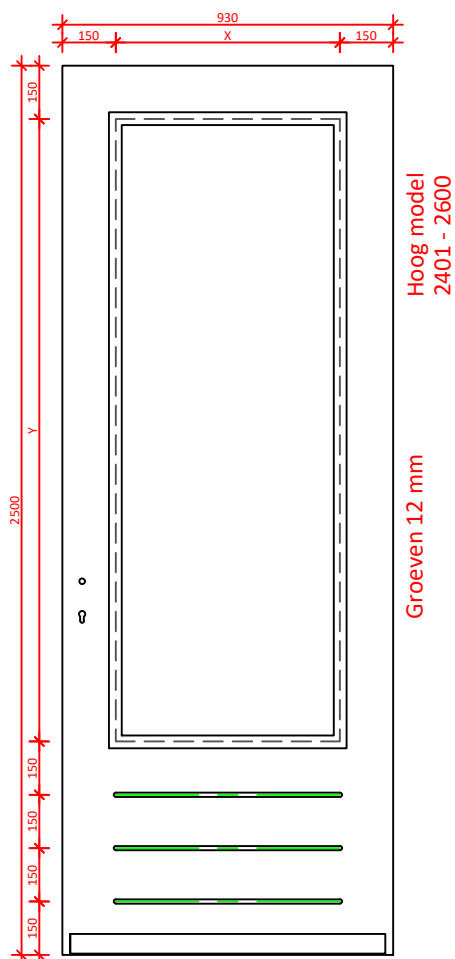
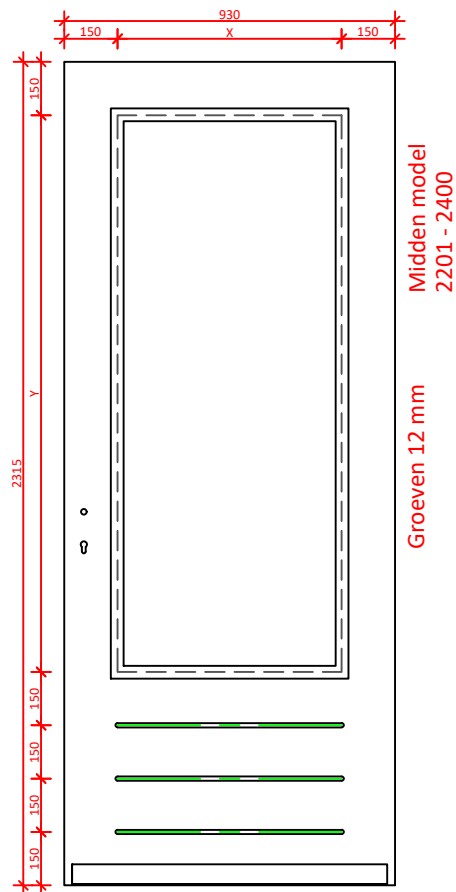
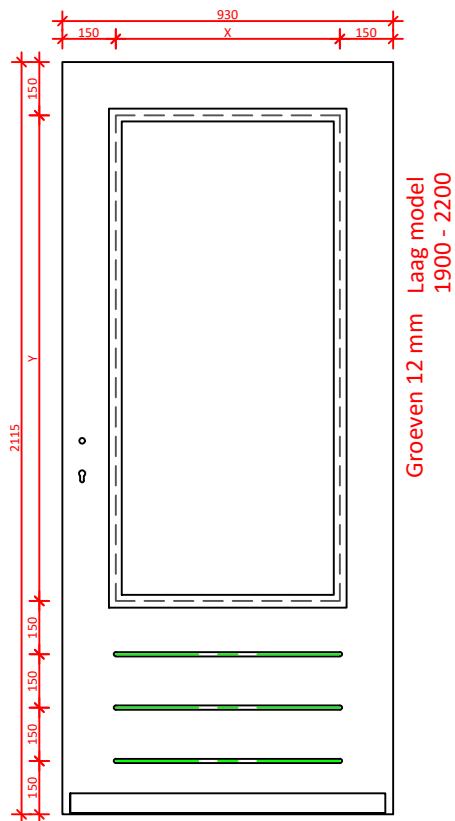

Alleen in KegaPro 74 mm.

| | | | | | |
|--------|------------|---------------|---------------------|----------------|------------|
| DATUM: | GEWIJZIGD: | CALCULATIENR: | TEKENINGNR: 9770 | MODEL: 9770 | HOUTSOORT: |
|--------|------------|---------------|---------------------|----------------|------------|

| | | | | |
|--|---------------------------------------------------|--|--|-------------|
| | KLANT/PROJECT: overzicht modellen 9770 L1 - R4 | | | DCM NUMMER: |
|--|---------------------------------------------------|--|--|-------------|

| | | | | |
|-----------|---------|-----------|------------|-----------|
| AANVRAAG: | SCHAAL: | GETEKEND: | LEVERWEEK: | 1.2a P.67 |
|-----------|---------|-----------|------------|-----------|

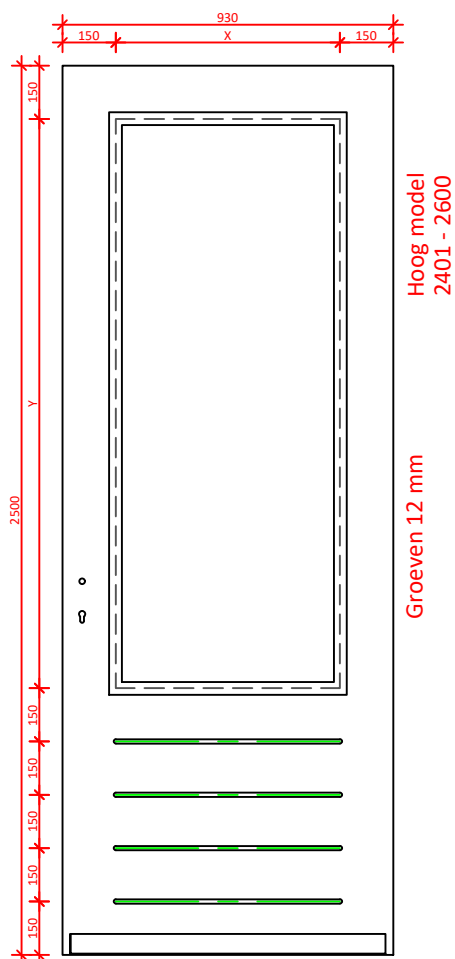
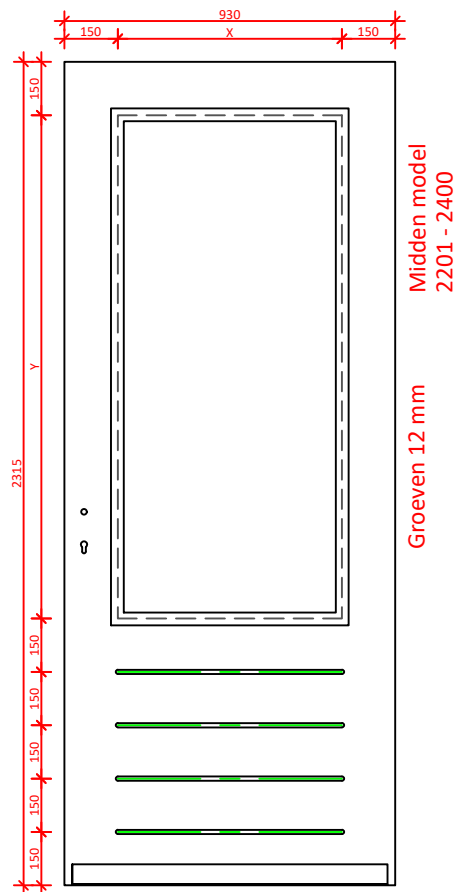
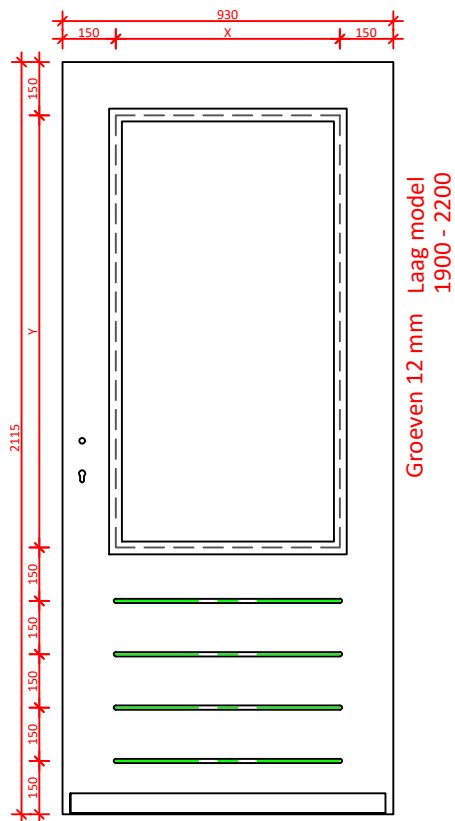

Alleen in KegaPro+ 74 mm.

| | | | | | |
|--------|------------|---------------|---------------------|----------------|------------|
| DATUM: | GEWIJZIGD: | CALCULATIENR: | TEKENINGNR: 9771 | MODEL: 9771 | HOUTSOORT: |
|--------|------------|---------------|---------------------|----------------|------------|

| | | | | |
|-----------------------|---------------------------------------------------|--|--|-------------|
| KEGRO DEUREN | KLANT/PROJECT: overzicht modellen 9771 L1 - R4 | | | DCM NUMMER: |
|-----------------------|---------------------------------------------------|--|--|-------------|

| | | | | |
|-----------|---------|-----------|------------|-----------|
| AANVRAAG: | SCHAAL: | GETEKEND: | LEVERWEEK: | 1.2a P.68 |
|-----------|---------|-----------|------------|-----------|

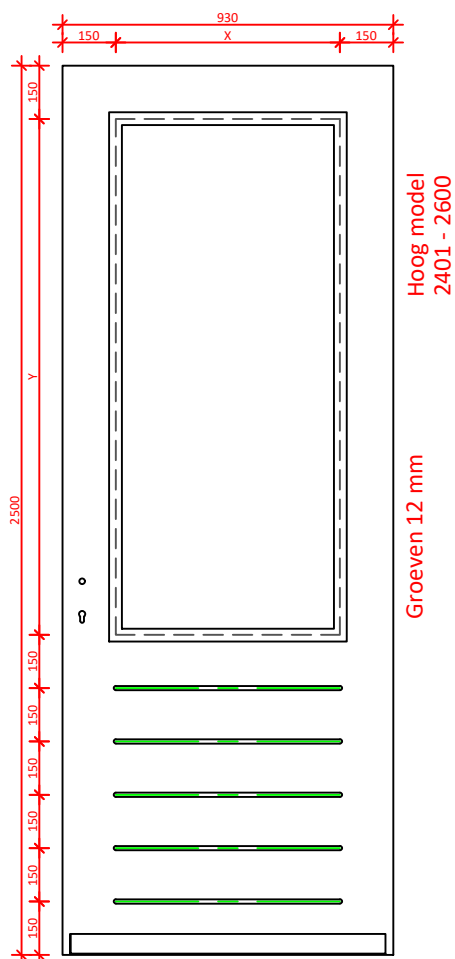
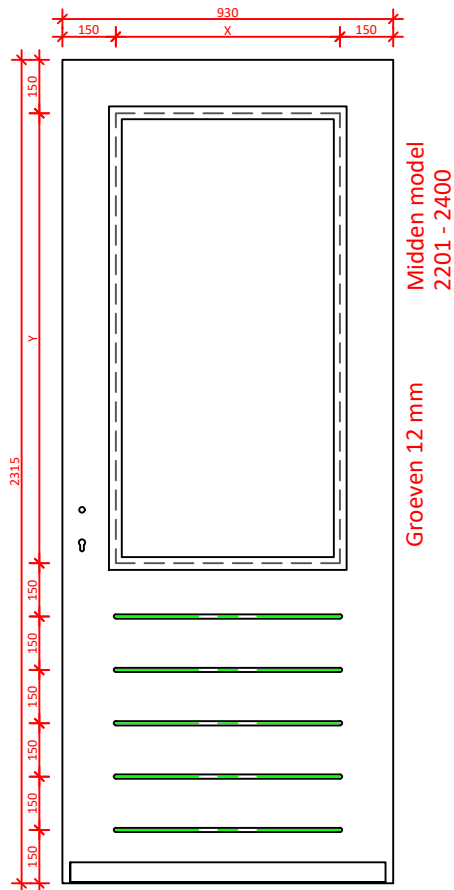
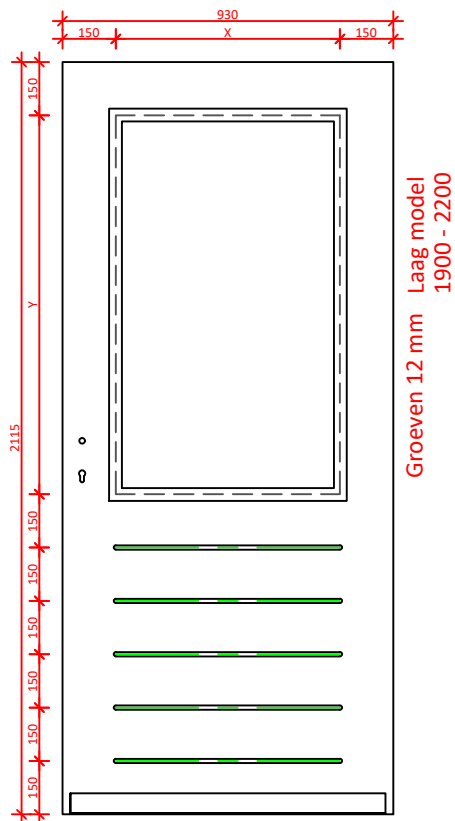

Alleen in KegaPro+ 74 mm.

| | | | | | |
|--------|------------|---------------|---------------------|----------------|------------|
| DATUM: | GEWIJZIGD: | CALCULATIENR: | TEKENINGNR: 9772 | MODEL: 9772 | HOUTSOORT: |
|--------|------------|---------------|---------------------|----------------|------------|

| | | | | |
|--|---------------------------------------------------|--|--|-------------|
| | KLANT/PROJECT: overzicht modellen 9772 L1 - R4 | | | DCM NUMMER: |
|--|---------------------------------------------------|--|--|-------------|

| | | | | |
|-----------|---------|-----------|------------|-----------|
| AANVRAAG: | SCHAAL: | GETEKEND: | LEVERWEEK: | 1.2a P.69 |
|-----------|---------|-----------|------------|-----------|

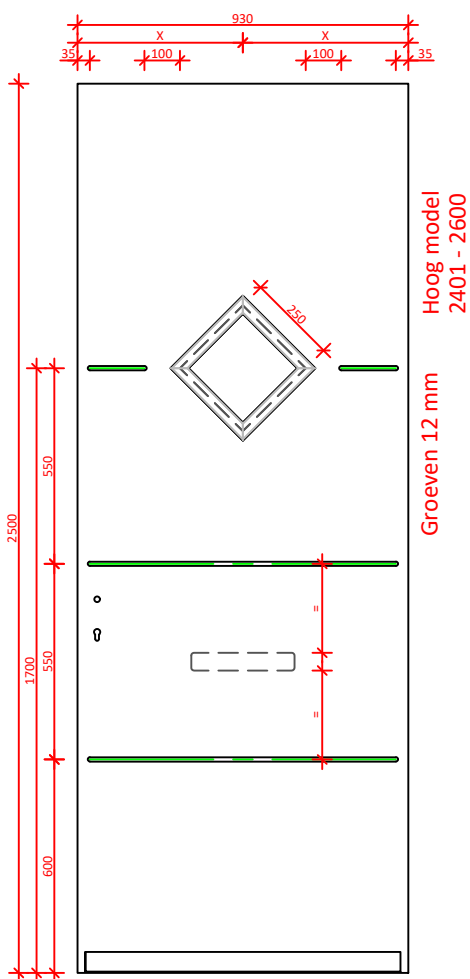
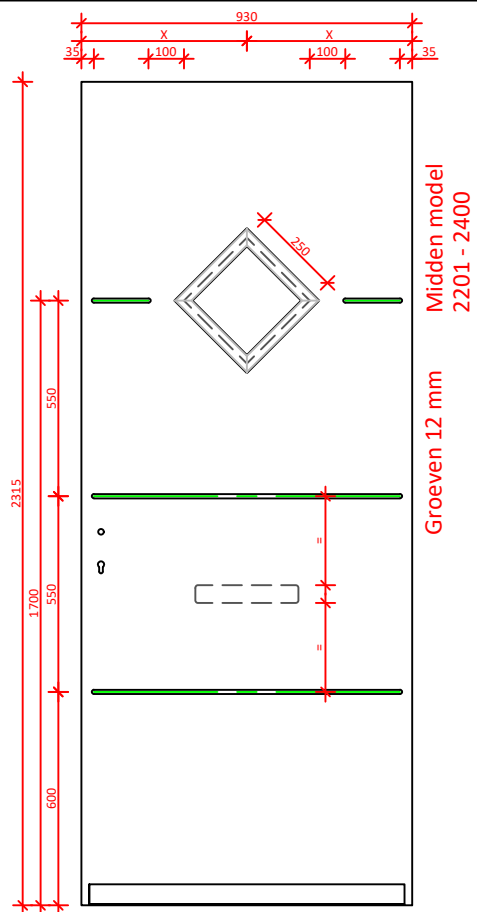
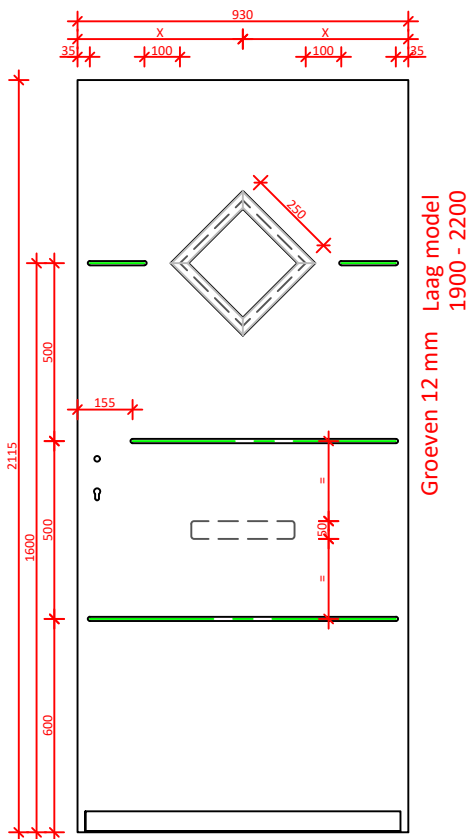

| | | | | | |
|--------|------------|---------------|-------------|-----------------|------------|
| DATUM: | GEWIJZIGD: | CALCULATIENR: | TEKENINGNR: | MODEL: 9801N | HOUTSOORT: |
|--------|------------|---------------|-------------|-----------------|------------|

| | | | | |
|------------------------------------------------------------------------------------|-----------------------------------------------------------|--|--|-------------|
|  | KLANT/PROJECT: overzicht modellen 9801N met briefsleuf | | | DCM NUMMER: |
|------------------------------------------------------------------------------------|-----------------------------------------------------------|--|--|-------------|

| | | | |
|-----------|---------|-----------------|-------------------------|
| AANVRAAG: | SCHAAL: | GETEKEND: MN | LEVERWEEK: 1.2a P.70 |
|-----------|---------|-----------------|-------------------------|

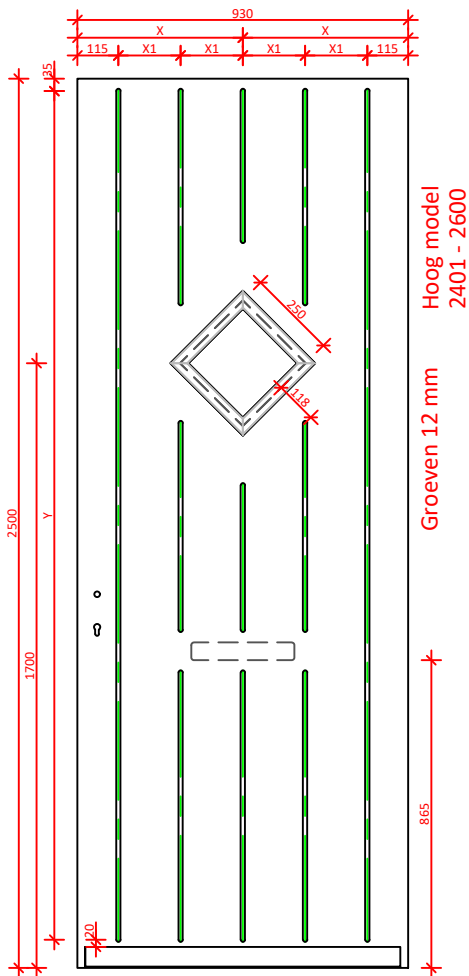
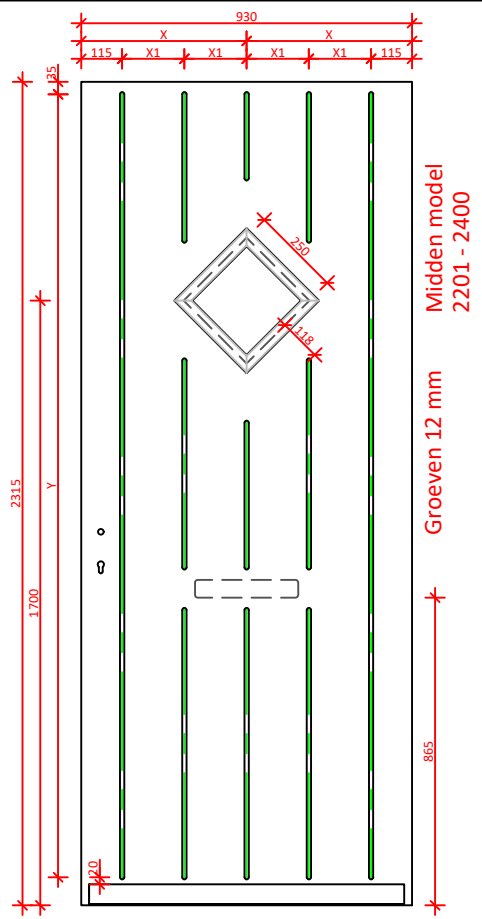
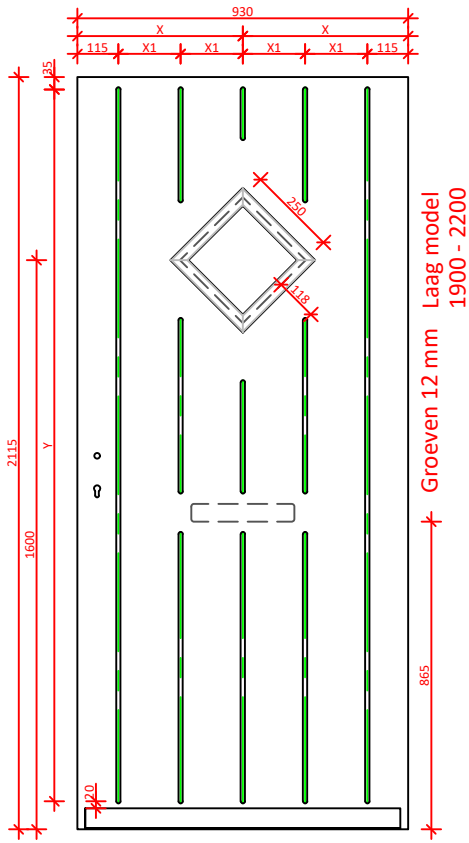

| | | | | | |
|--------|------------|---------------|-------------|-----------------|------------|
| DATUM: | GEWIJZIGD: | CALCULATIENR: | TEKENINGNR: | MODEL: 9802N | HOUTSOORT: |
|--------|------------|---------------|-------------|-----------------|------------|

| | | | | |
|--|-----------------------------------------------------------|--|--|-------------|
| | KLANT/PROJECT: overzicht modellen 9802N met briefsleuf | | | DCM NUMMER: |
|--|-----------------------------------------------------------|--|--|-------------|

| | | | | |
|-----------|---------|-----------------|------------|-----------|
| AANVRAAG: | SCHAAL: | GETEKEND: MN | LEVERWEEK: | 1.2a P.71 |
|-----------|---------|-----------------|------------|-----------|

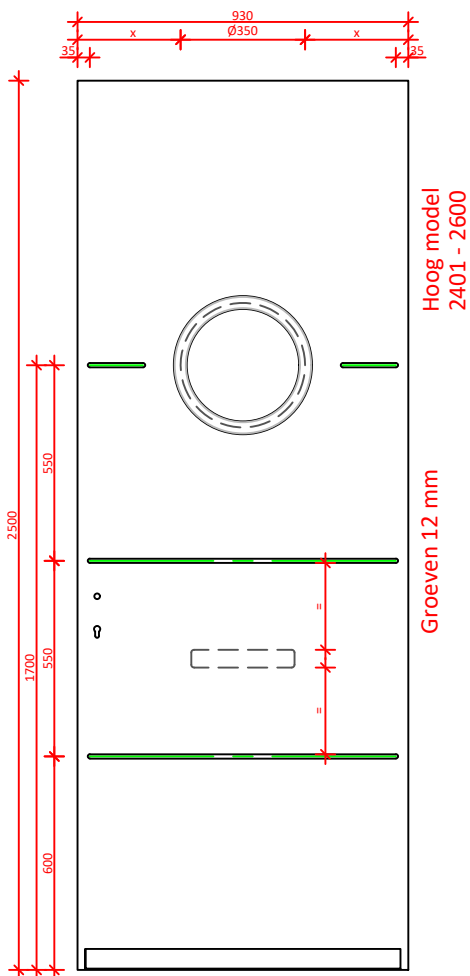
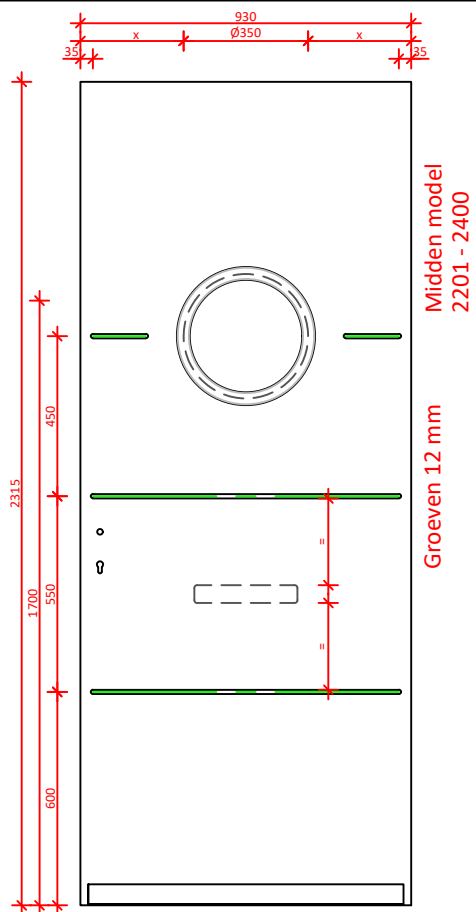
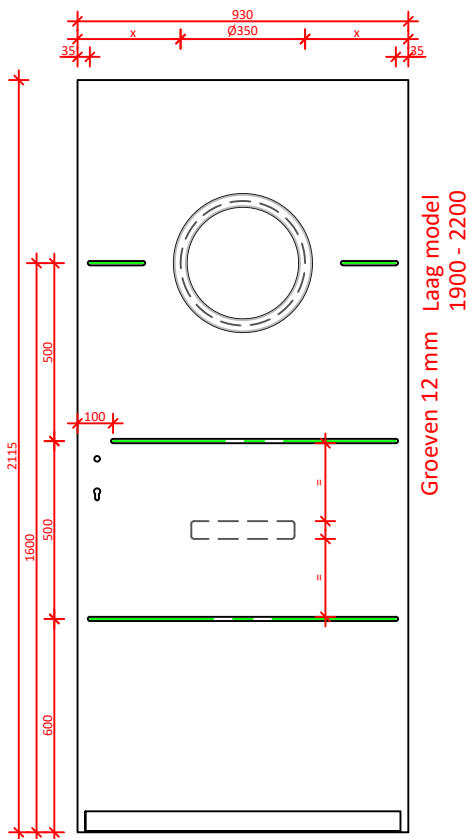

| | | | | | |
|--------|------------|---------------|----------------------|--------|------------|
| DATUM: | GEWIJZIGD: | CALCULATIENR: | TEKENINGNR: 9807N | MODEL: | HOUTSOORT: |
|--------|------------|---------------|----------------------|--------|------------|

| | | | | |
|--|--------------------------------------------|--|--|-------------|
| | KLANT/PROJECT: overzicht modellen 9807N | | | DCM NUMMER: |
|--|--------------------------------------------|--|--|-------------|

| | | | | |
|-----------|---------|-----------|------------|-----------|
| AANVRAAG: | SCHAAL: | GETEKEND: | LEVERWEEK: | 1.2a P.72 |
|-----------|---------|-----------|------------|-----------|

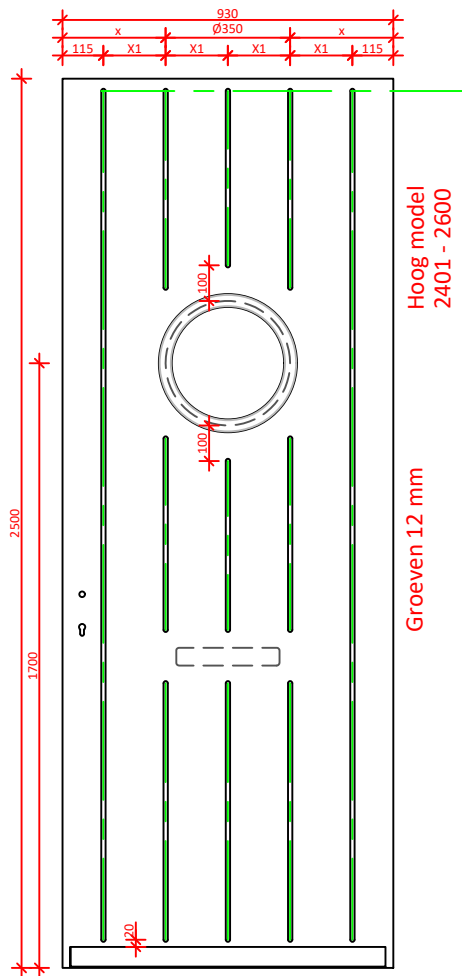
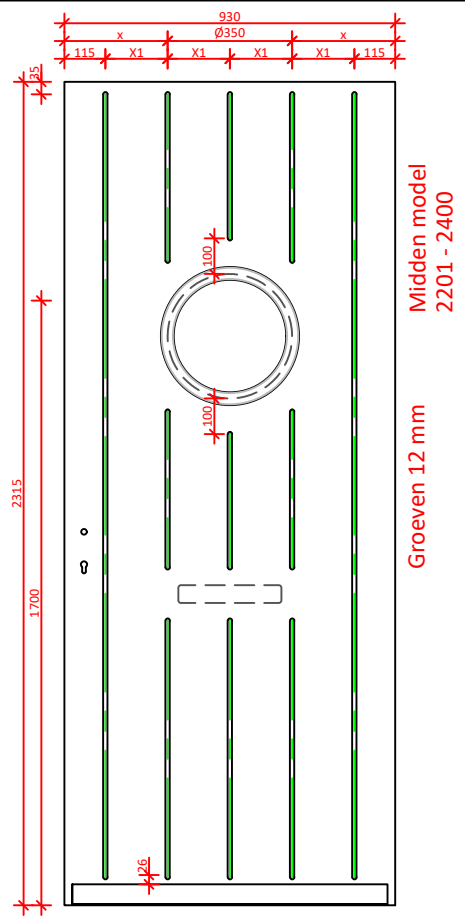
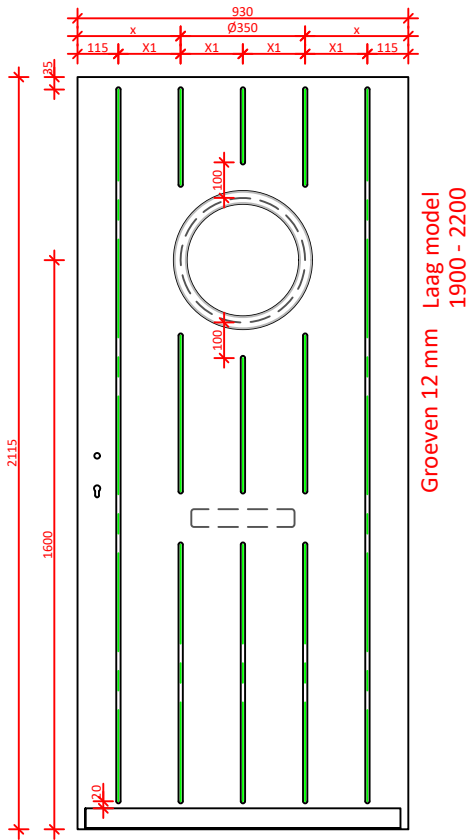

| | | | | | |
|------------------------------------------------------------------------------------|------------|---------------|-----------------------------------------------------------|---------|-------------|
| DATUM: | GEWIJZIGD: | CALCULATIENR: | TEKENINGNR: 9808N | MODEL: | HOUTSOORT: |
|  | | | KLANT/PROJECT: overzicht modellen 9808N met briefsleuf | | DCM NUMMER: |
| | | | AANVRAAG: | SCHAAL: | GETEKEND: |

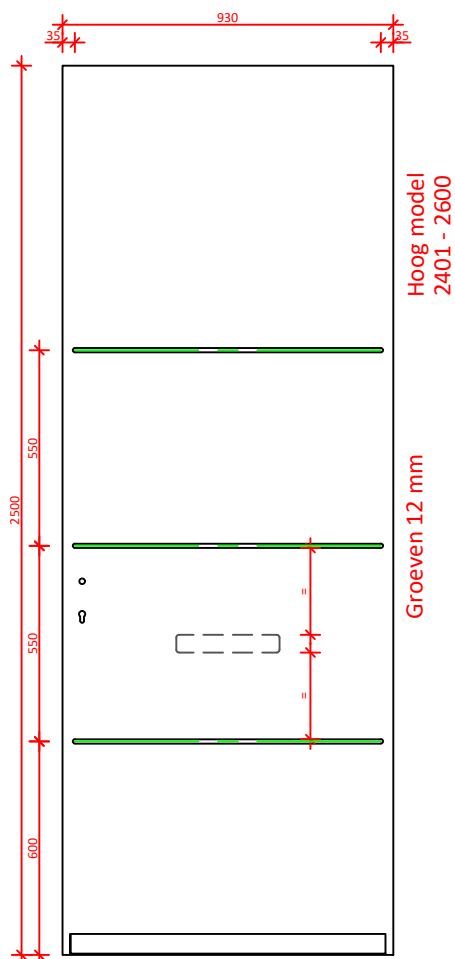
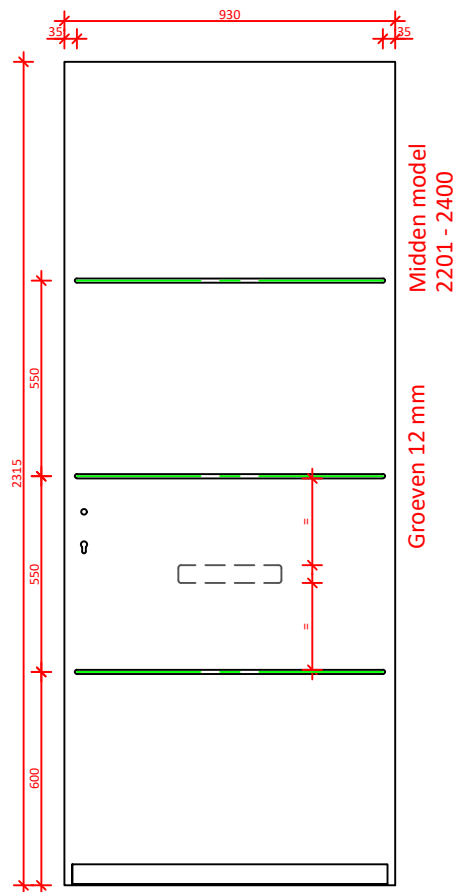
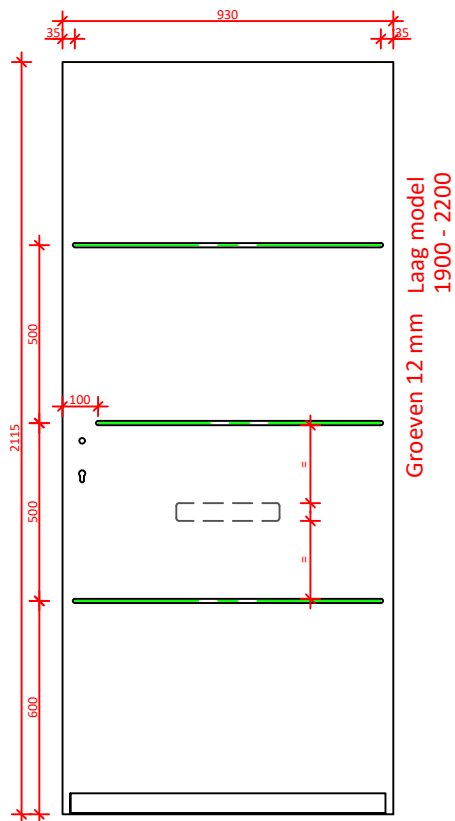

| | | | | | |
|--------|------------|---------------|----------------------|--------|------------|
| DATUM: | GEWIJZIGD: | CALCULATIENR: | TEKENINGNR: 9813N | MODEL: | HOUTSOORT: |
|--------|------------|---------------|----------------------|--------|------------|

| | | | | | |
|-----------------------|--------------------------------------------|--|--|-------------|--|
| KEGRO DEUREN | KLANT/PROJECT: overzicht modellen 9813N | | | DCM NUMMER: | |
|-----------------------|--------------------------------------------|--|--|-------------|--|

| | | | | |
|-----------|---------|-----------|------------|-----------|
| AANVRAAG: | SCHAAL: | GETEKEND: | LEVERWEEK: | 1.2a P.74 |
|-----------|---------|-----------|------------|-----------|

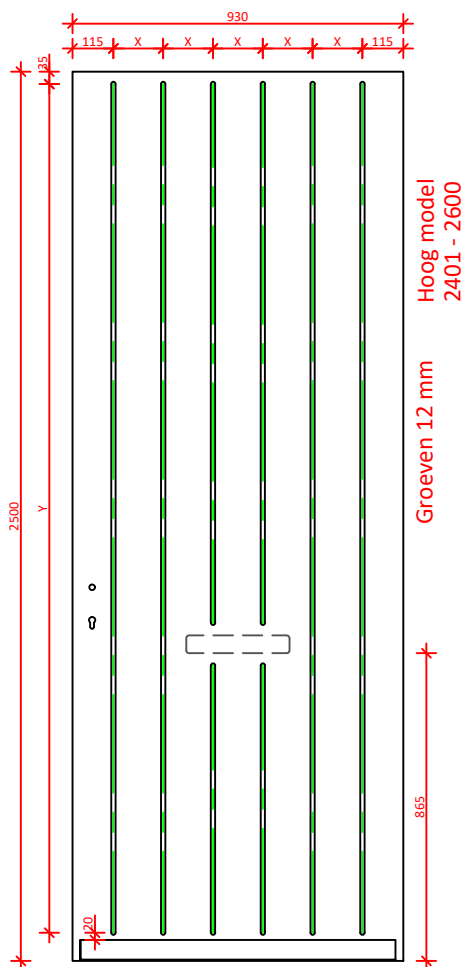
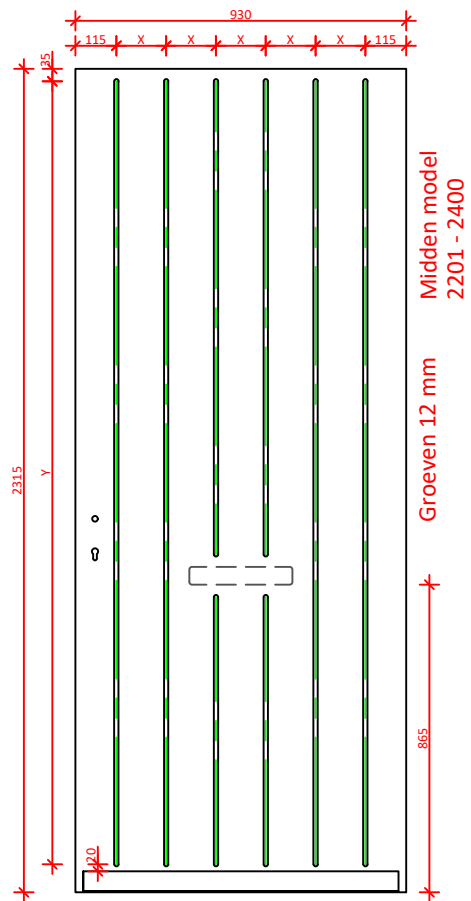
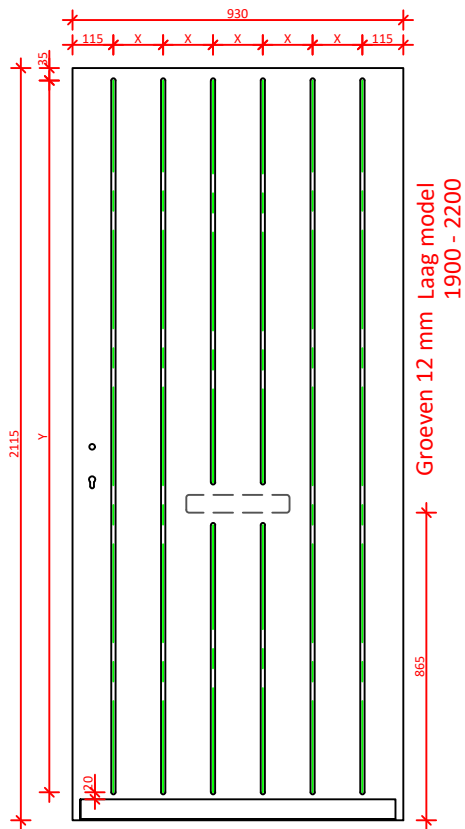

| | | | | | |
|--------|------------|---------------|-------------|----------------|------------|
| DATUM: | GEWIJZIGD: | CALCULATIENR: | TEKENINGNR: | MODEL: 9814 | HOUTSOORT: |
|--------|------------|---------------|-------------|----------------|------------|

| | | | | |
|--|-------------------------------------------|--|--|-------------|
| | KLANT/PROJECT: overzicht modellen 9814 | | | DCM NUMMER: |
|--|-------------------------------------------|--|--|-------------|

| | | | |
|-----------|---------|-----------------|-------------------------|
| AANVRAAG: | SCHAAL: | GETEKEND: MN | LEVERWEEK: 1.2a P.75 |
|-----------|---------|-----------------|-------------------------|

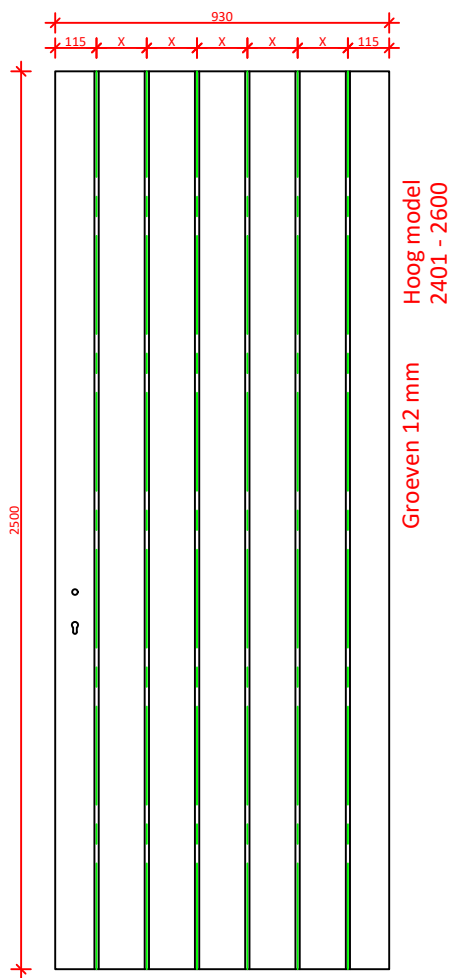
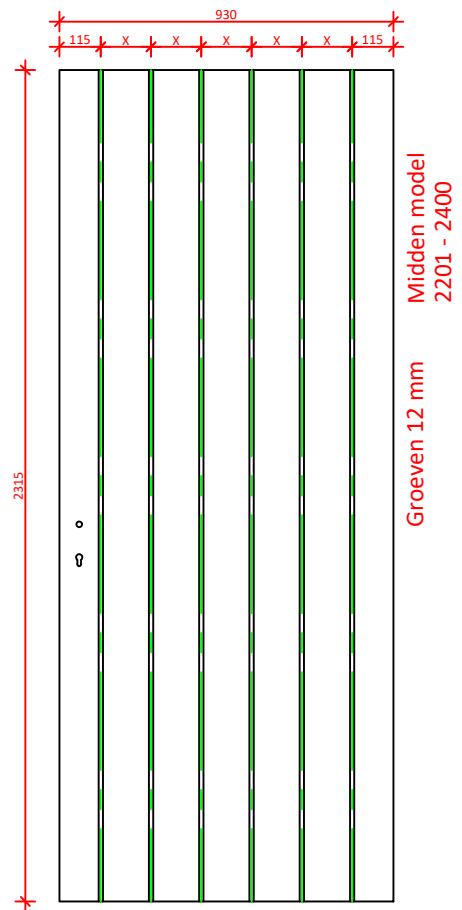
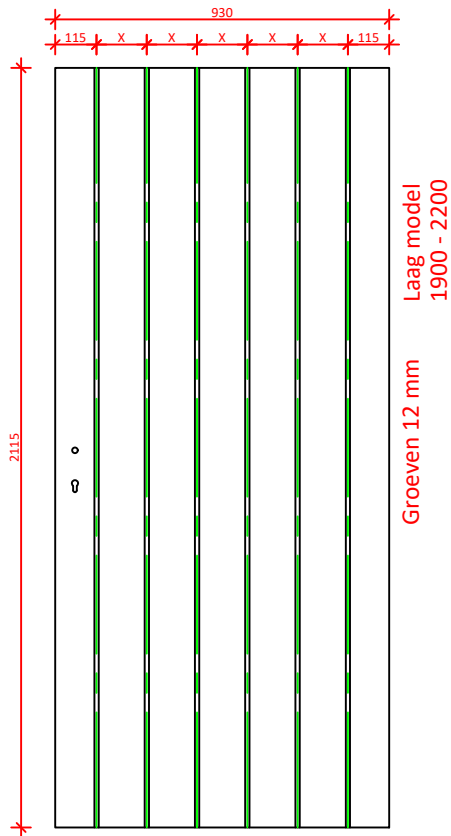

| | | | | | |
|--------|------------|---------------|---------------------|----------------|------------|
| DATUM: | GEWIJZIGD: | CALCULATIENR: | TEKENINGNR: 9815 | MODEL: 9815 | HOUTSOORT: |
|--------|------------|---------------|---------------------|----------------|------------|

| | | | | |
|--|-------------------------------------------|--|--|-------------|
| | KLANT/PROJECT: overzicht modellen 9815 | | | DCM NUMMER: |
|--|-------------------------------------------|--|--|-------------|

| | | | |
|-----------|---------|-----------------|-------------------------|
| AANVRAAG: | SCHAAL: | GETEKEND: MN | LEVERWEEK: 1.2a P.76 |
|-----------|---------|-----------------|-------------------------|

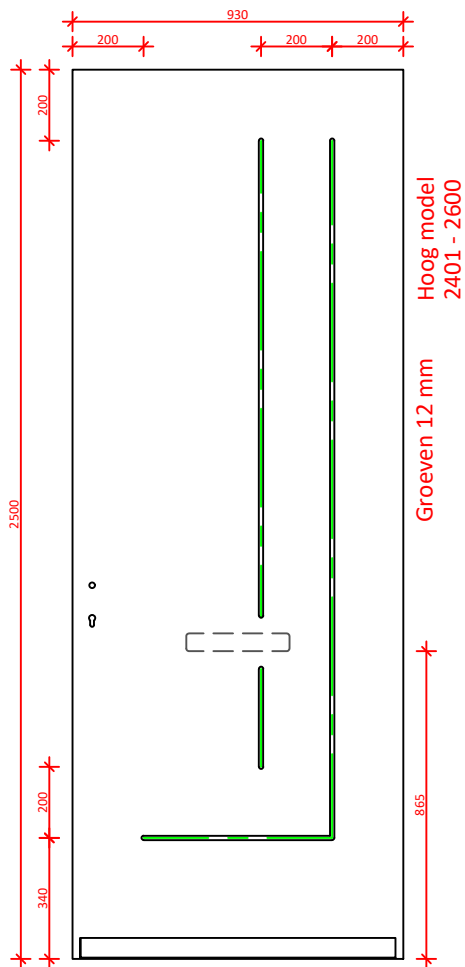
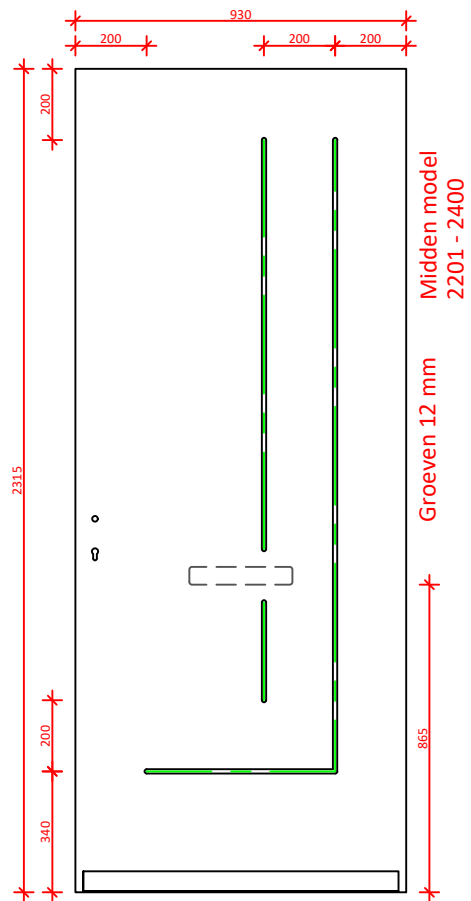
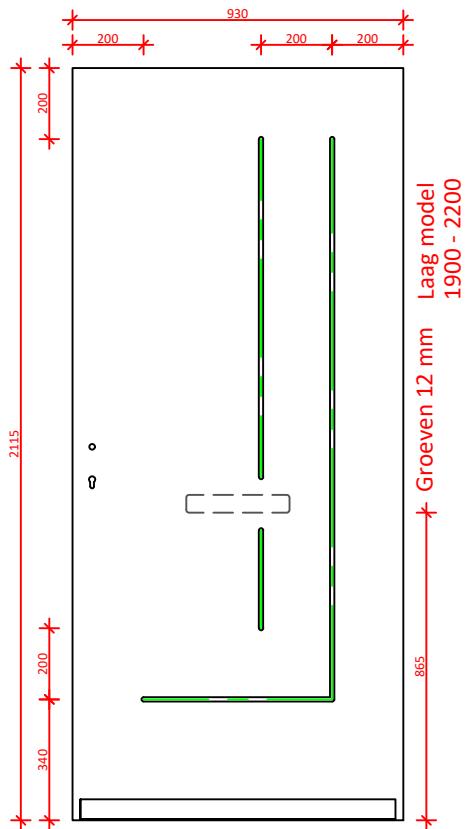

| | | | | | |
|--------|------------|---------------|-------------|----------------|------------|
| DATUM: | GEWIJZIGD: | CALCULATIENR: | TEKENINGNR: | MODEL: 9816 | HOUTSOORT: |
|--------|------------|---------------|-------------|----------------|------------|

| | | | | |
|--|----------------------------------------------------------|--|--|-------------|
| | KLANT/PROJECT: overzicht modellen 9816 met briefsleuf | | | DCM NUMMER: |
|--|----------------------------------------------------------|--|--|-------------|

| | | | | |
|-----------|---------|-----------------|------------|-----------|
| AANVRAAG: | SCHAAL: | GETEKEND: MN | LEVERWEEK: | 1.2a P.77 |
|-----------|---------|-----------------|------------|-----------|

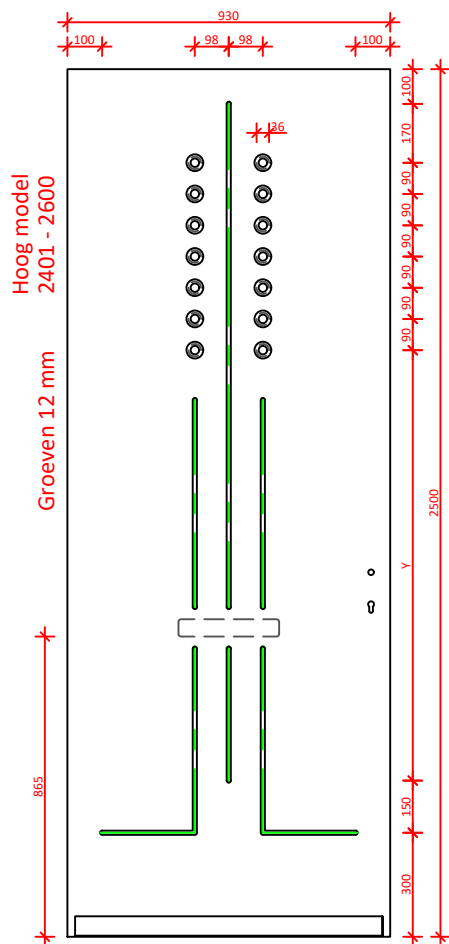
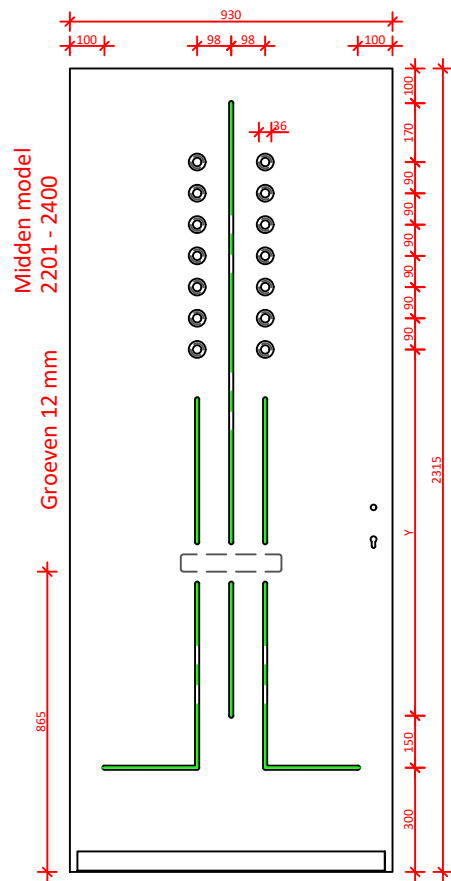
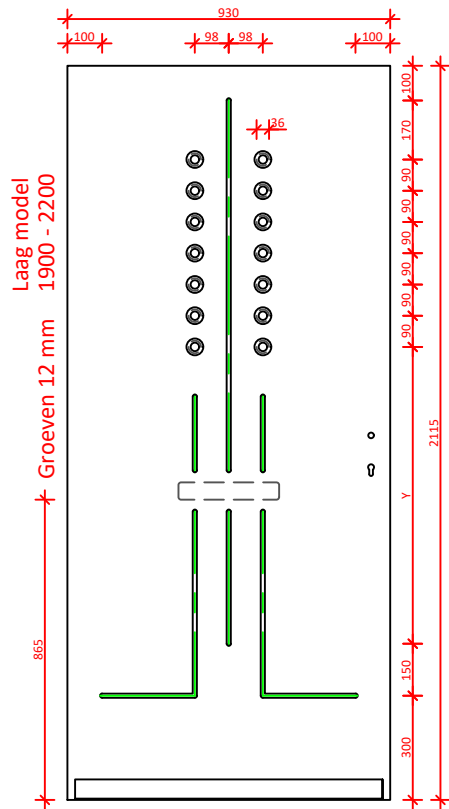

| | | | | | |
|-----------|------------|---------------|------------------------------------------------------------------|-------------------------|-------------|
| DATUM: | GEWIJZIGD: | CALCULATIENR: | TEKENINGNR: | MODEL: 9814 | HOUTSOORT: |
| | | | KLANT/PROJECT: overzicht modellen 9817 met briefsleuf R2 - L3 | | DCM NUMMER: |
| AANVRAAG: | | SCHAAL: | GETEKEND: MN | LEVERWEEK: 1.2a P.78 | |

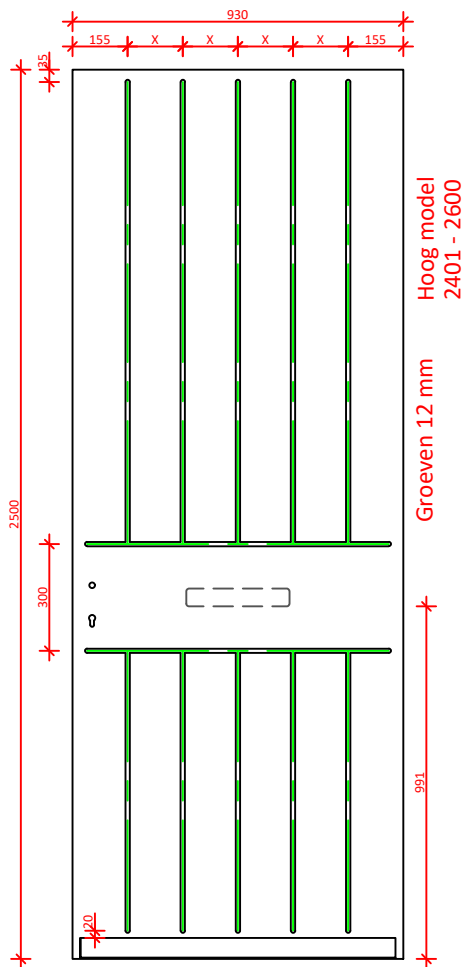
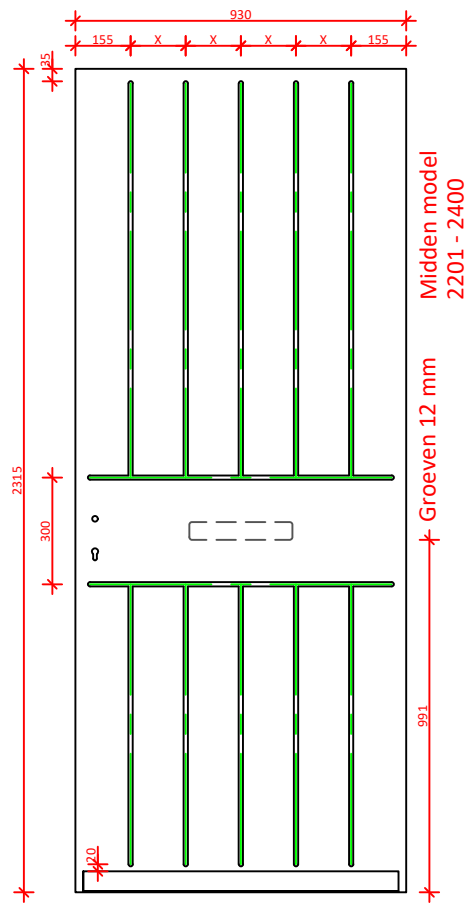
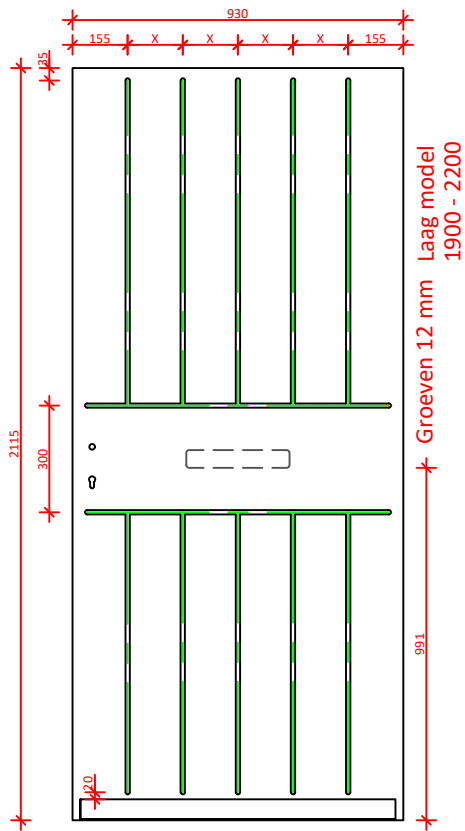

| | | | | | |
|--------|------------|---------------|-------------|----------------|------------|
| DATUM: | GEWIJZIGD: | CALCULATIENR: | TEKENINGNR: | MODEL: 9821 | HOUTSOORT: |
|--------|------------|---------------|-------------|----------------|------------|

| | | | | |
|--|-------------------------------------------|--|--|-------------|
| | KLANT/PROJECT: overzicht modellen 9821 | | | DCM NUMMER: |
|--|-------------------------------------------|--|--|-------------|

| | | | |
|-----------|---------|-----------------|-------------------------|
| AANVRAAG: | SCHAAL: | GETEKEND: MN | LEVERWEEK: 1.2a P.79 |
|-----------|---------|-----------------|-------------------------|

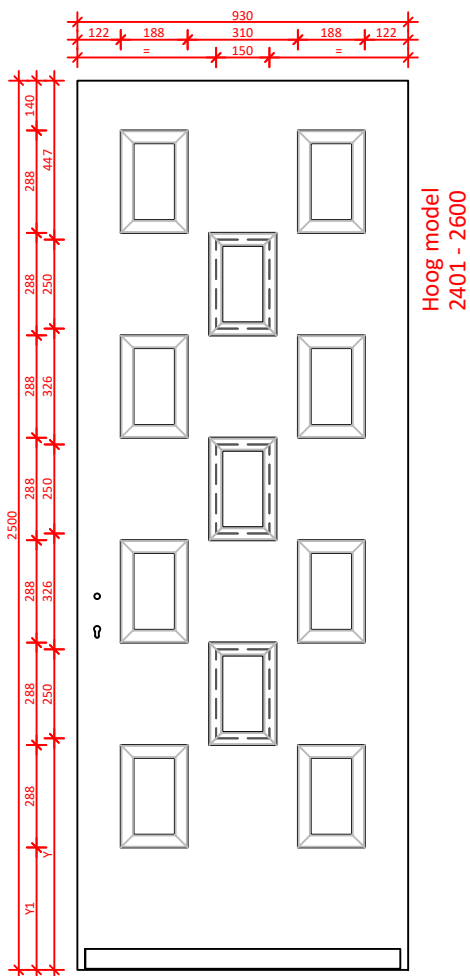
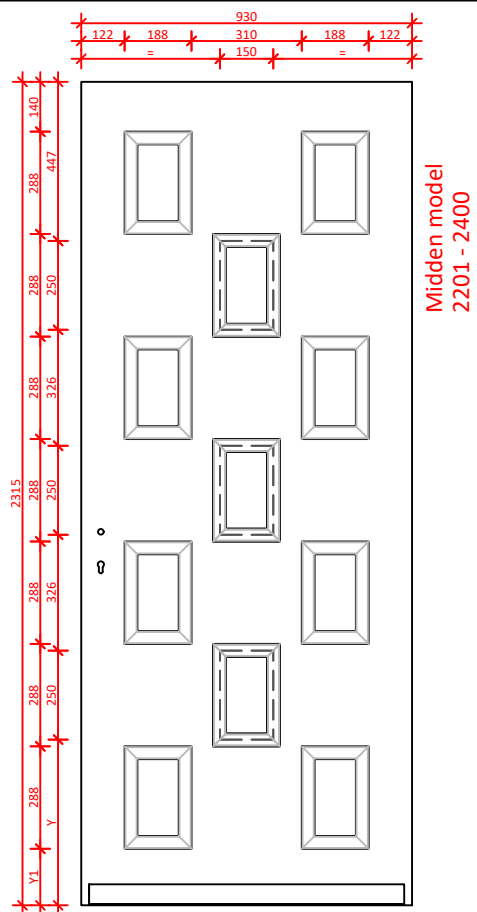
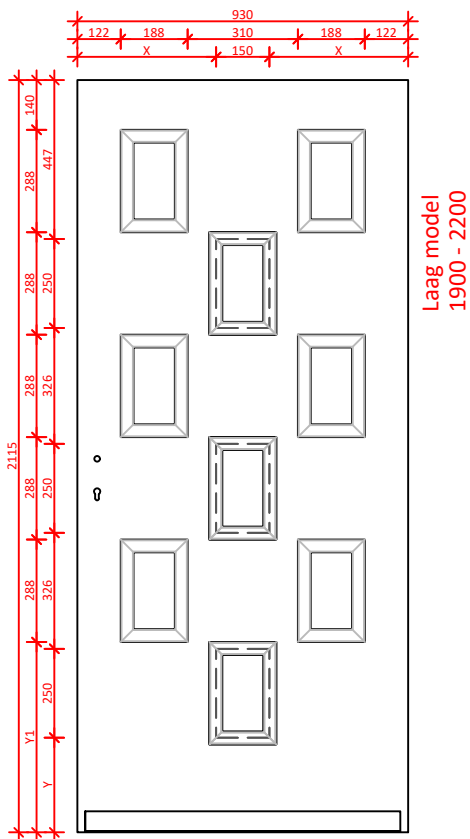

| | | | | | |
|--------|------------|---------------|-------------|-----------------|------------|
| DATUM: | GEWIJZIGD: | CALCULATIENR: | TEKENINGNR: | MODEL: 9823N | HOUTSOORT: |
|--------|------------|---------------|-------------|-----------------|------------|

| | | | | |
|--|--------------------------------------------|--|--|-------------|
| | KLANT/PROJECT: overzicht modellen 9823N | | | DCM NUMMER: |
|--|--------------------------------------------|--|--|-------------|

| | | | | |
|-----------|---------|-----------------|------------|-----------|
| AANVRAAG: | SCHAAL: | GETEKEND: MN | LEVERWEEK: | 1.2a P.80 |
|-----------|---------|-----------------|------------|-----------|

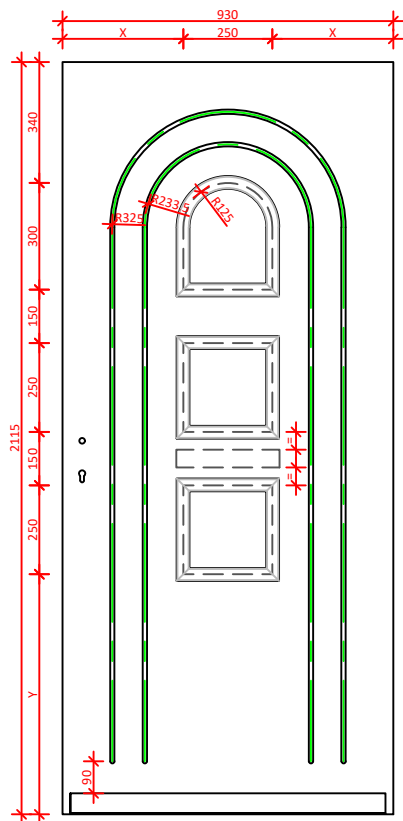

Groeven 12 mm Laag model
1900 - 2200

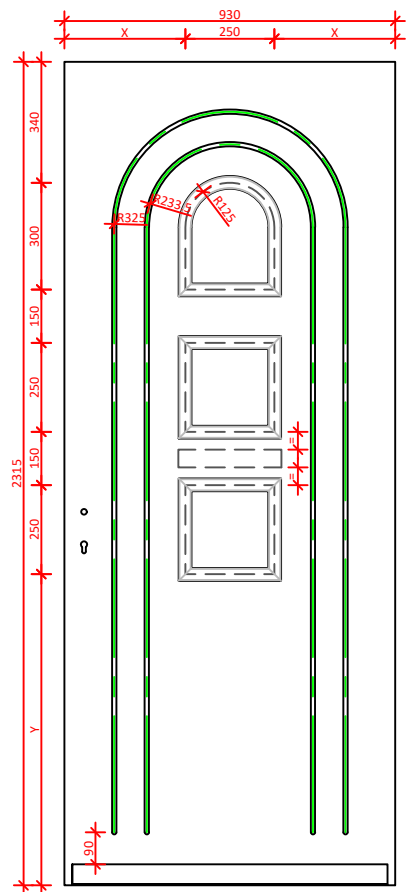

Groeven 12 mm Midden model
2201 - 2400

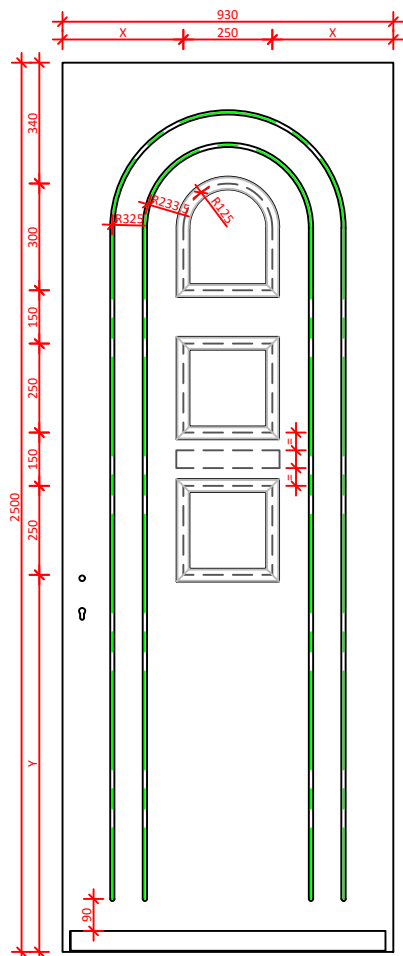

Groeven 12 mm Hoog model
2401 - 2600

| | | | | | |
|--------|------------|---------------|-------------|-----------------|------------|
| DATUM: | GEWIJZIGD: | CALCULATIENR: | TEKENINGNR: | MODEL: 9825N | HOUTSOORT: |
|--------|------------|---------------|-------------|-----------------|------------|

| | | | | |
|--|--------------------------------------------|--|--|-------------|
| | KLANT/PROJECT: overzicht modellen 9825N | | | DCM NUMMER: |
|--|--------------------------------------------|--|--|-------------|

| | | | | |
|-----------|---------|-----------------|------------|-----------|
| AANVRAAG: | SCHAAL: | GETEKEND: MN | LEVERWEEK: | 1.2a P.81 |
|-----------|---------|-----------------|------------|-----------|

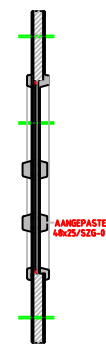
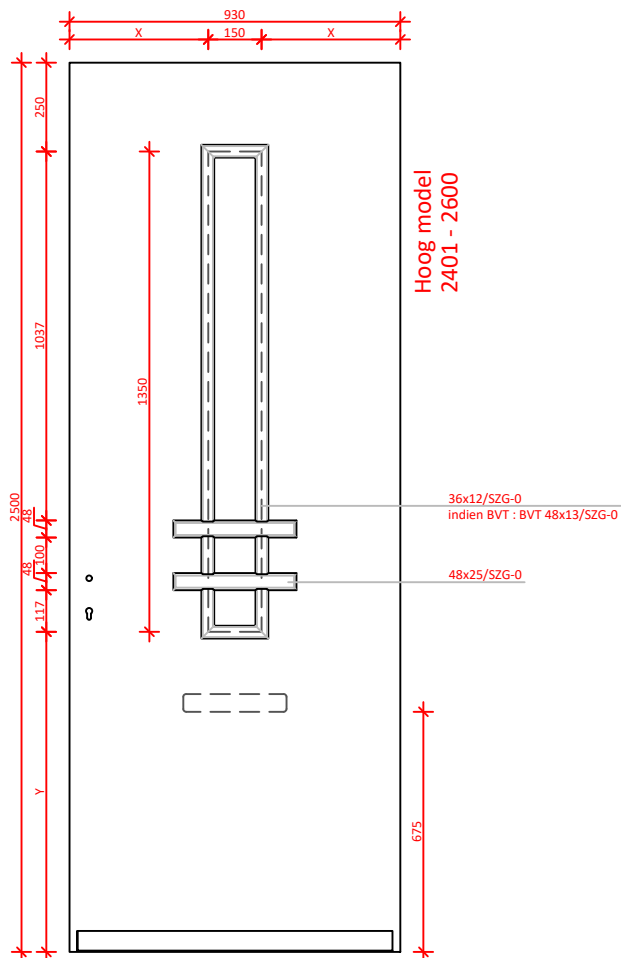
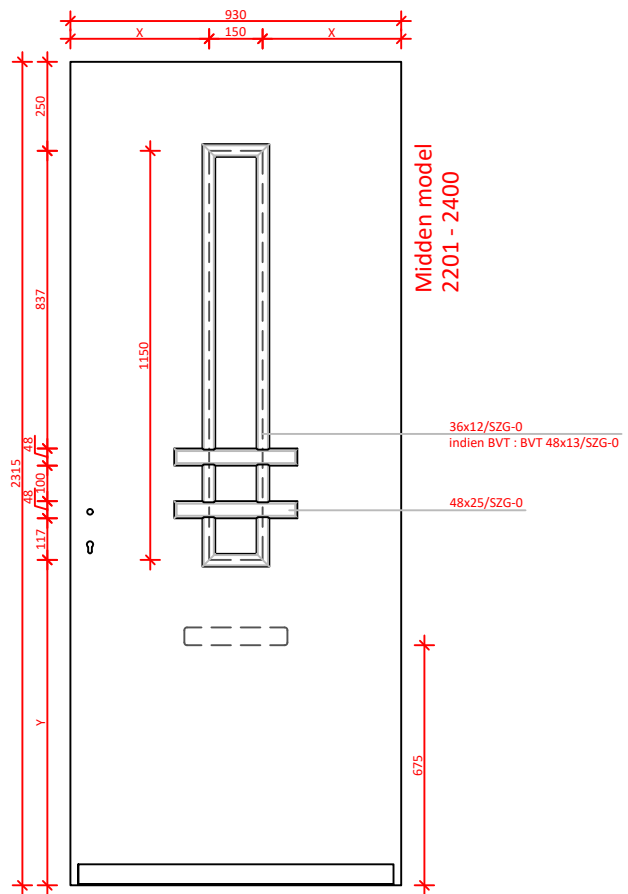
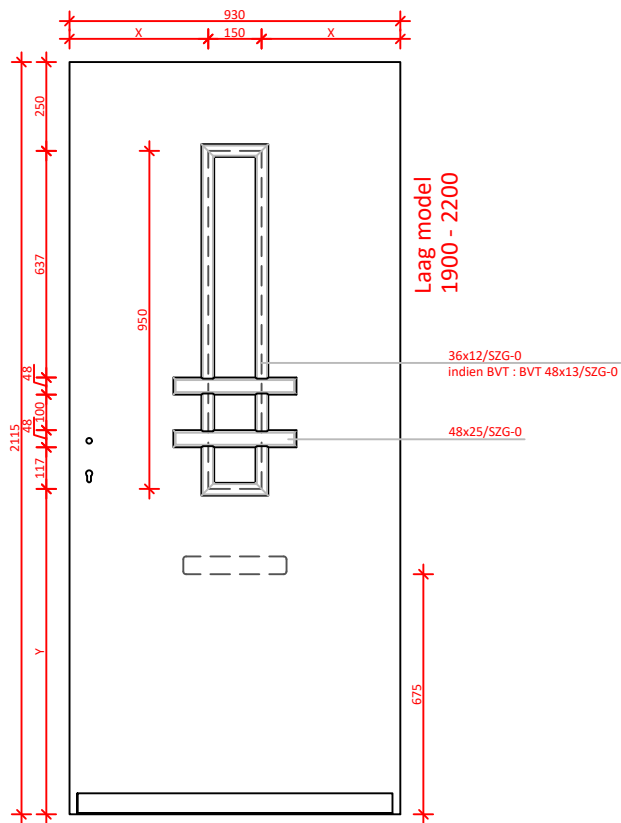

| | | | | | |
|--------|------------|---------------|----------------------|--------|------------|
| DATUM: | GEWIJZIGD: | CALCULATIENR: | TEKENINGNR: 9828N | MODEL: | HOUTSOORT: |
|--------|------------|---------------|----------------------|--------|------------|

| | | | | |
|-----------------------|--------------------------------------------|--|--|-------------|
| KEGRO DEUREN | KLANT/PROJECT: overzicht modellen 9828N | | | DCM NUMMER: |
|-----------------------|--------------------------------------------|--|--|-------------|

| | | | | |
|-----------|---------|-----------|------------|-----------|
| AANVRAAG: | SCHAAL: | GETEKEND: | LEVERWEEK: | 1.2a P.82 |
|-----------|---------|-----------|------------|-----------|

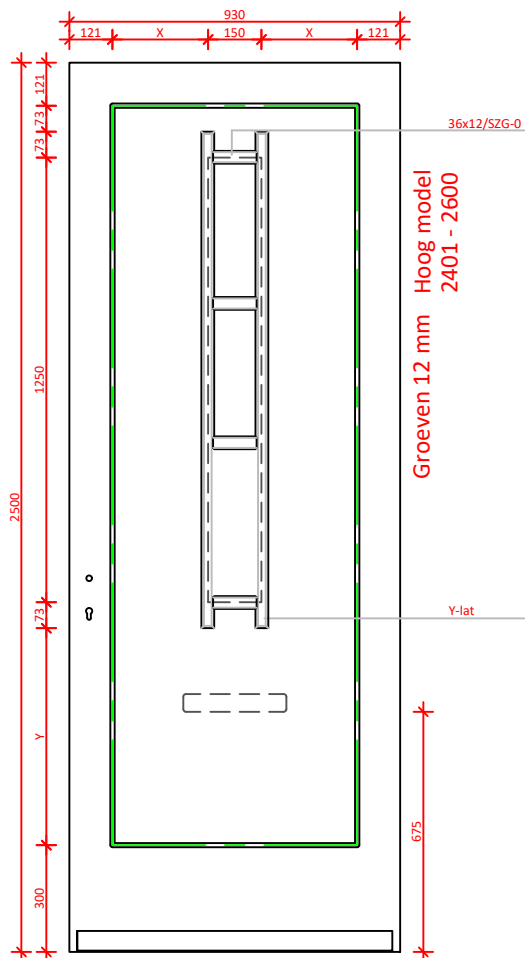
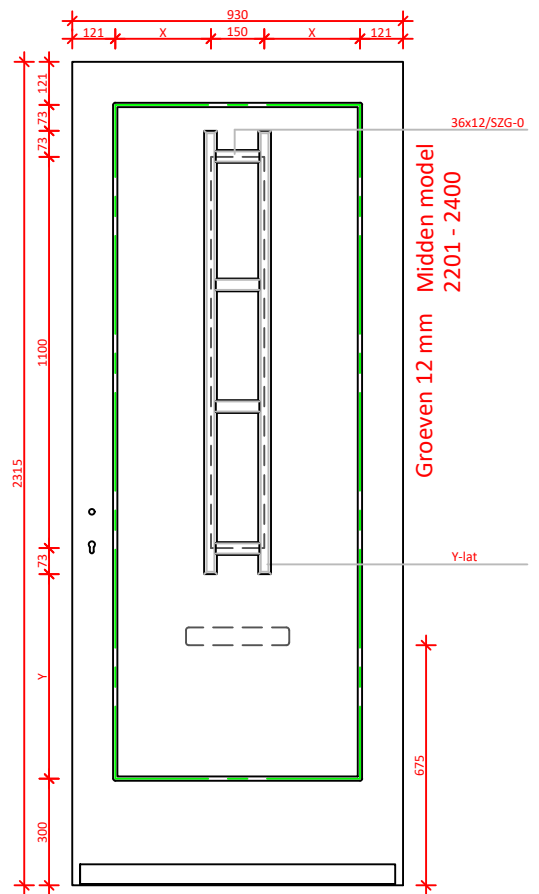
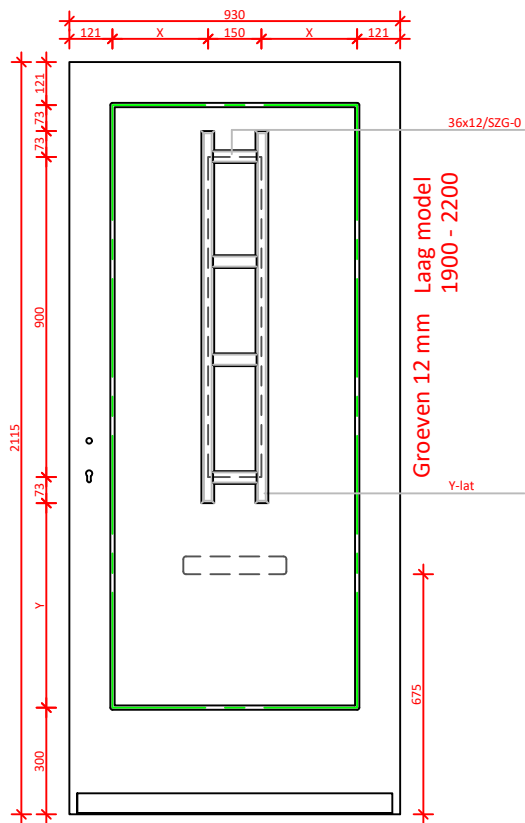

| | | | | | |
|--------|------------|---------------|----------------------|--------|------------|
| DATUM: | GEWIJZIGD: | CALCULATIENR: | TEKENINGNR: 9829N | MODEL: | HOUTSOORT: |
|--------|------------|---------------|----------------------|--------|------------|

| | | | | |
|--|--------------------------------------------|--|--|-------------|
| | KLANT/PROJECT: overzicht modellen 9829N | | | DCM NUMMER: |
|--|--------------------------------------------|--|--|-------------|

| | | | | |
|-----------|---------|-----------|------------|-----------|
| AANVRAAG: | SCHAAL: | GETEKEND: | LEVERWEEK: | 1.2a P.83 |
|-----------|---------|-----------|------------|-----------|

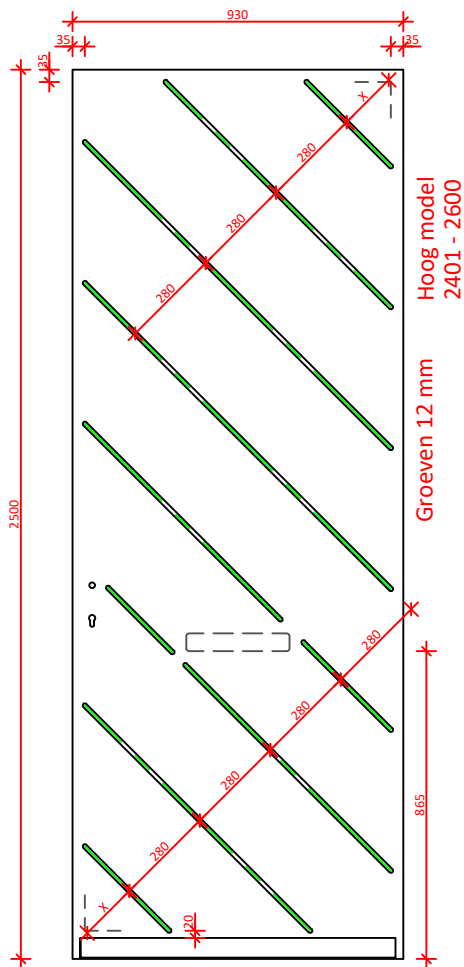
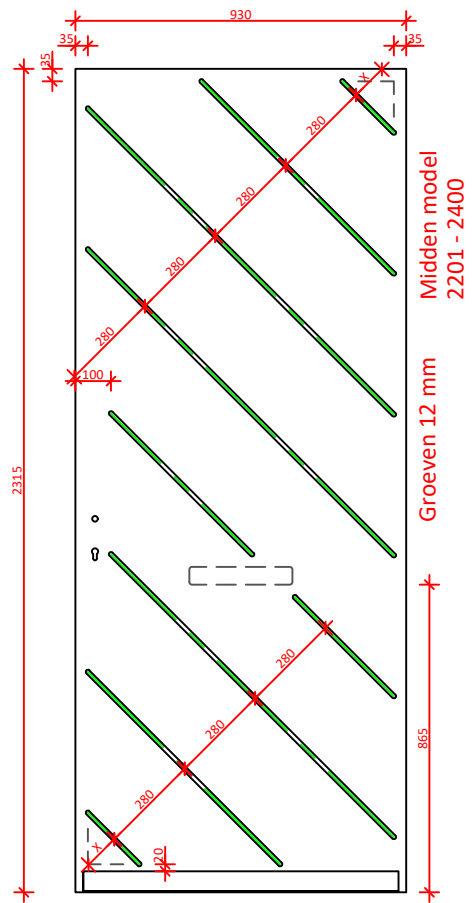
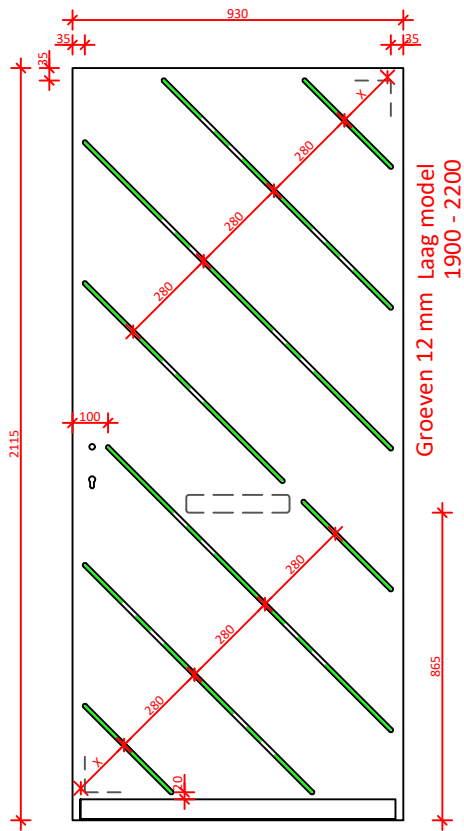

| | | | | | |
|--------|------------|---------------|-------------|----------------|------------|
| DATUM: | GEWIJZIGD: | CALCULATIENR: | TEKENINGNR: | MODEL: 9830 | HOUTSOORT: |
|--------|------------|---------------|-------------|----------------|------------|

| | | | | |
|--|----------------------------------------------------------|--|--|-------------|
| | KLANT/PROJECT: overzicht modellen 9830 met briefsleuf | | | DCM NUMMER: |
|--|----------------------------------------------------------|--|--|-------------|

| | | | | |
|-----------|---------|-----------------|------------|-----------|
| AANVRAAG: | SCHAAL: | GETEKEND: MN | LEVERWEEK: | 1.2a P.84 |
|-----------|---------|-----------------|------------|-----------|

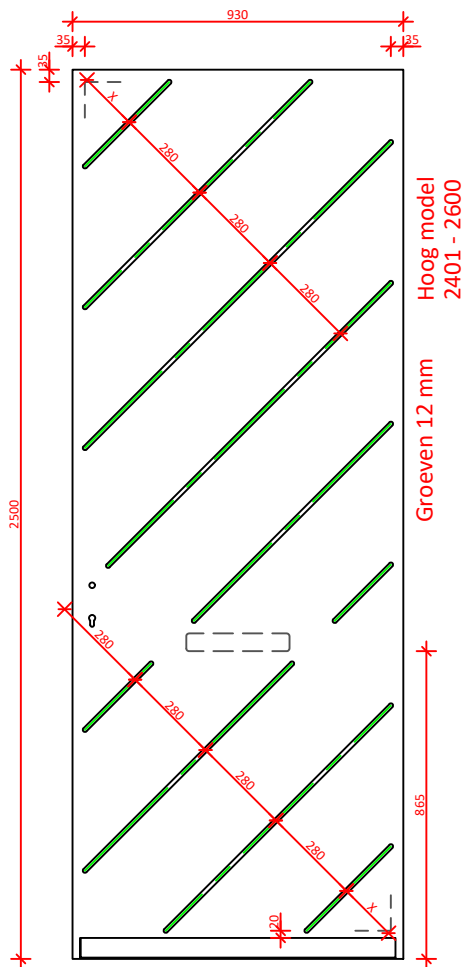
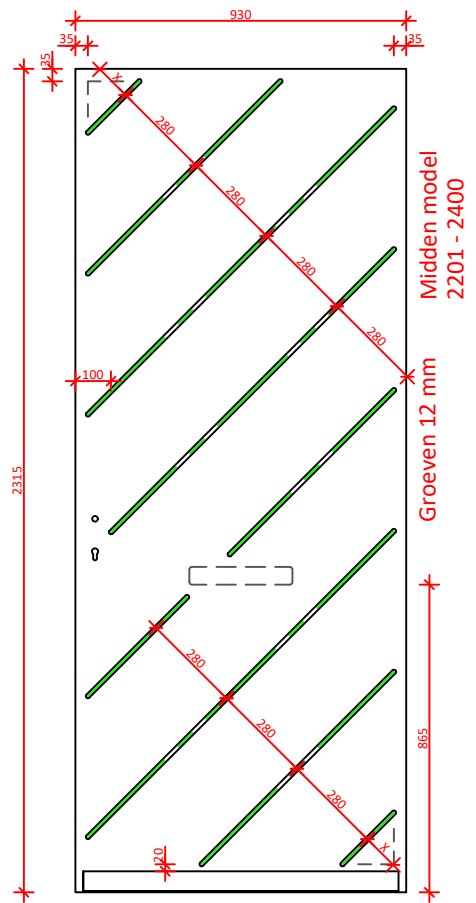
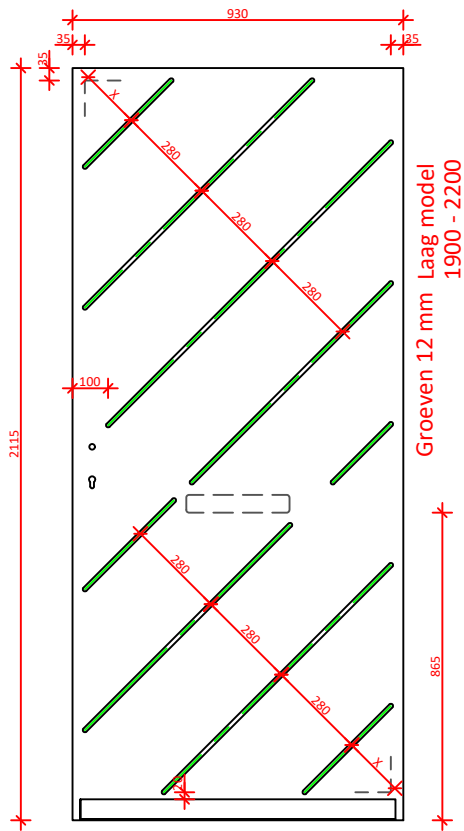

| | | | | | |
|--------|------------|---------------|-------------|----------------|------------|
| DATUM: | GEWIJZIGD: | CALCULATIENR: | TEKENINGNR: | MODEL: 9831 | HOUTSOORT: |
|--------|------------|---------------|-------------|----------------|------------|

| | | | | |
|--|----------------------------------------------------------|--|--|-------------|
| | KLANT/PROJECT: overzicht modellen 9831 met briefsleuf | | | DCM NUMMER: |
|--|----------------------------------------------------------|--|--|-------------|

| | | | | |
|-----------|---------|-----------------|------------|-----------|
| AANVRAAG: | SCHAAL: | GETEKEND: MN | LEVERWEEK: | 1.2a P.85 |
|-----------|---------|-----------------|------------|-----------|

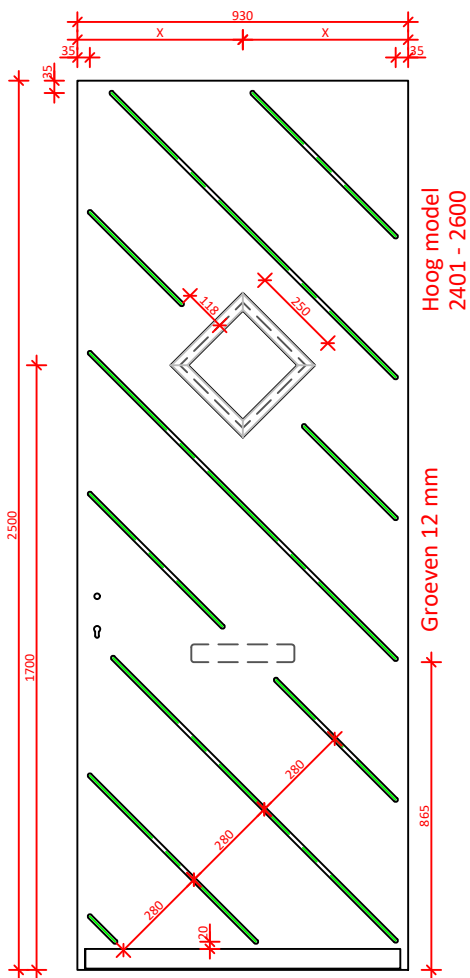
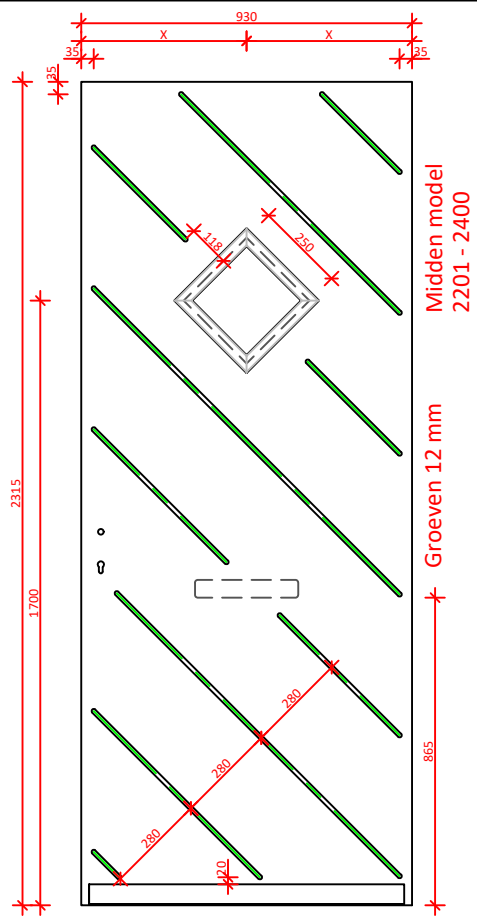
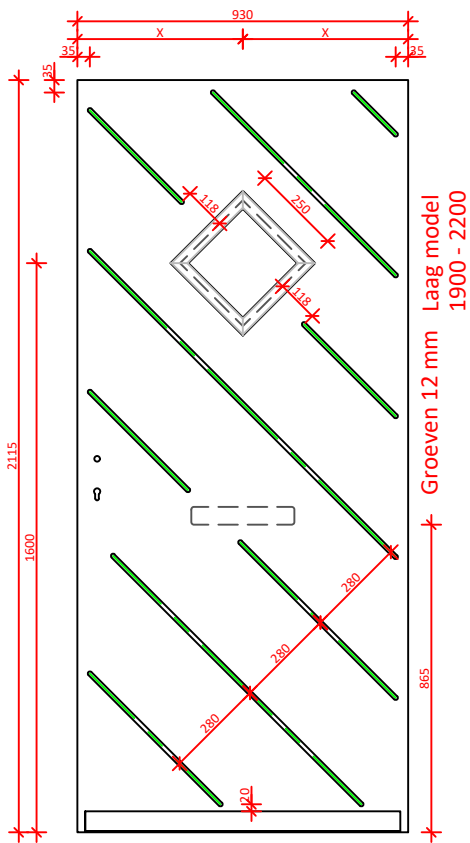

| | | | | | |
|--------|------------|---------------|-------------|-----------------|------------|
| DATUM: | GEWIJZIGD: | CALCULATIENR: | TEKENINGNR: | MODEL: 9832N | HOUTSOORT: |
|--------|------------|---------------|-------------|-----------------|------------|

| | | | | |
|--|-----------------------------------------------------------|--|--|-------------|
| | KLANT/PROJECT: overzicht modellen 9832N met briefsleuf | | | DCM NUMMER: |
|--|-----------------------------------------------------------|--|--|-------------|

| | | | | |
|-----------|---------|-----------------|------------|-----------|
| AANVRAAG: | SCHAAL: | GETEKEND: MN | LEVERWEEK: | 1.2a P.86 |
|-----------|---------|-----------------|------------|-----------|

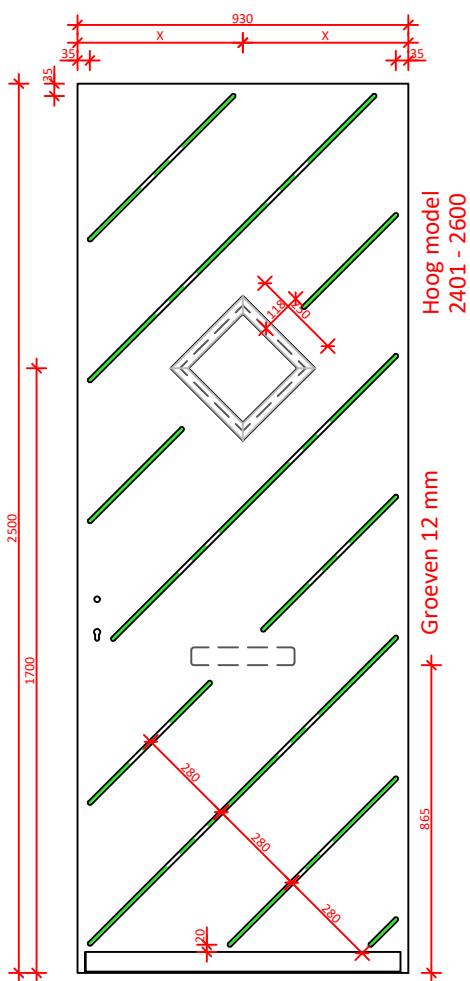
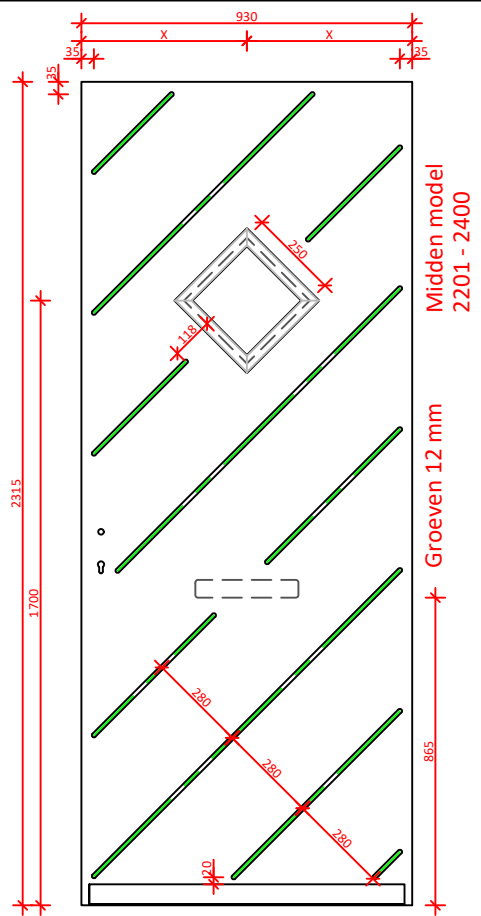
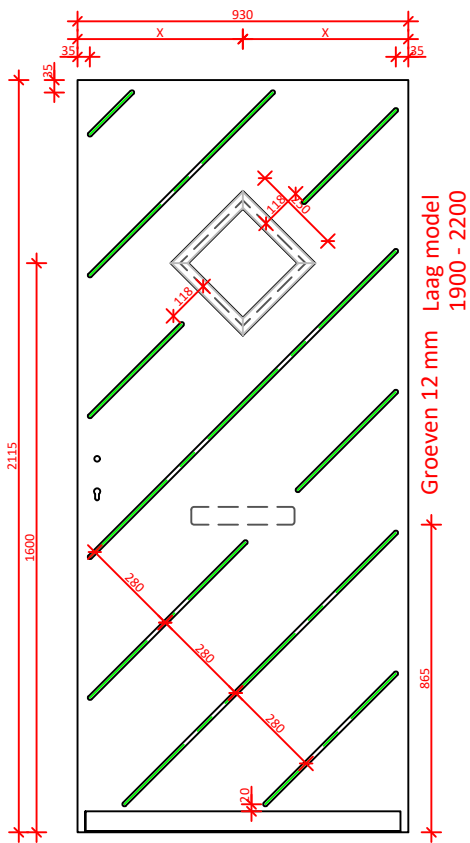

| | | | | | |
|--------|------------|---------------|-------------|-----------------|------------|
| DATUM: | GEWIJZIGD: | CALCULATIENR: | TEKENINGNR: | MODEL: 9833N | HOUTSOORT: |
|--------|------------|---------------|-------------|-----------------|------------|

| | | | | |
|--|-----------------------------------------------------------|--|--|-------------|
| | KLANT/PROJECT: overzicht modellen 9833N met briefsleuf | | | DCM NUMMER: |
|--|-----------------------------------------------------------|--|--|-------------|

| | | | | |
|-----------|---------|-----------------|------------|-----------|
| AANVRAAG: | SCHAAL: | GETEKEND: MN | LEVERWEEK: | 1.2a P.87 |
|-----------|---------|-----------------|------------|-----------|

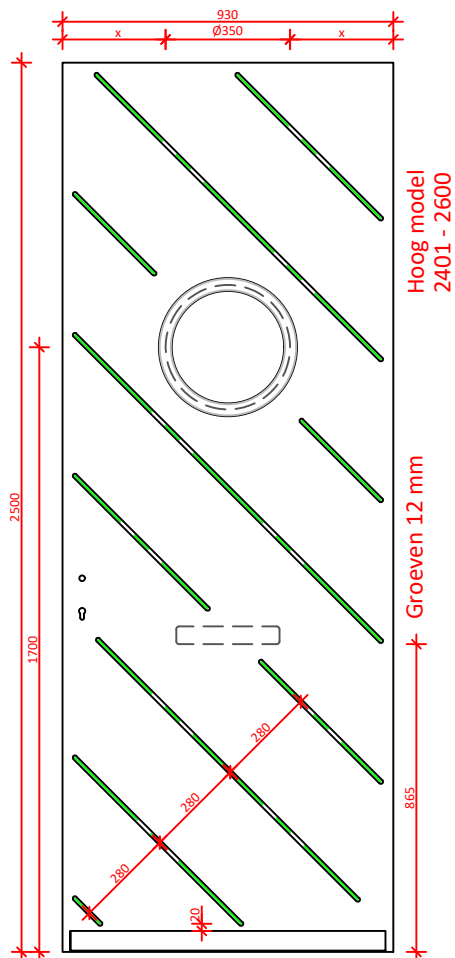
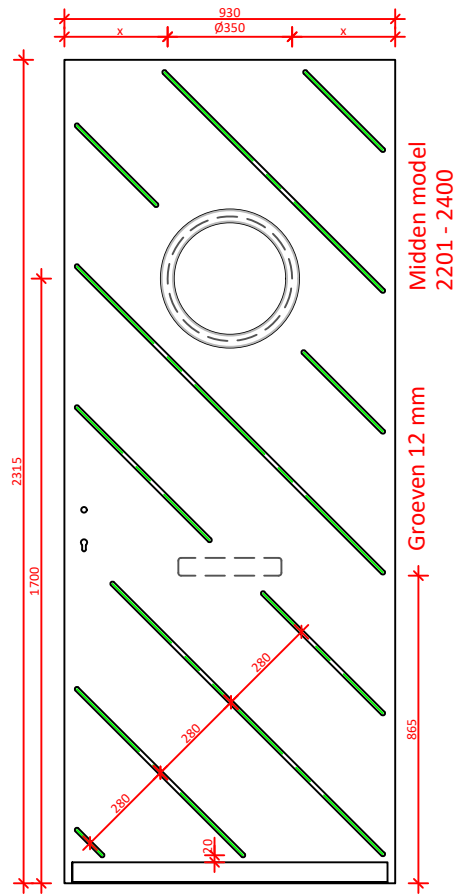
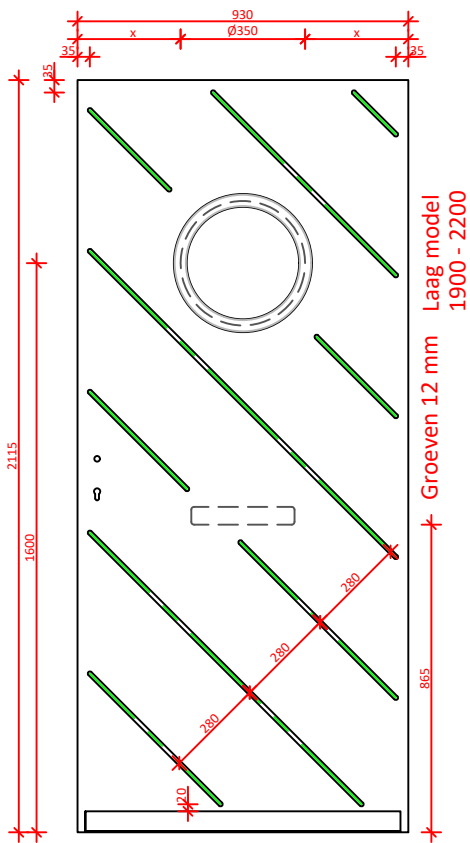

| | | | | | |
|--------|------------|---------------|----------------------|--------|------------|
| DATUM: | GEWIJZIGD: | CALCULATIENR: | TEKENINGNR: 9834N | MODEL: | HOUTSOORT: |
|--------|------------|---------------|----------------------|--------|------------|

| | | | | |
|--|----------------------------------------------------------|--|--|-------------|
| | KLANT/PROJECT: overzicht modellen 9834N met briefleuf | | | DCM NUMMER: |
|--|----------------------------------------------------------|--|--|-------------|

| | | | | |
|-----------|---------|-----------|------------|-----------|
| AANVRAAG: | SCHAAL: | GETEKEND: | LEVERWEEK: | 1.2a P.88 |
|-----------|---------|-----------|------------|-----------|

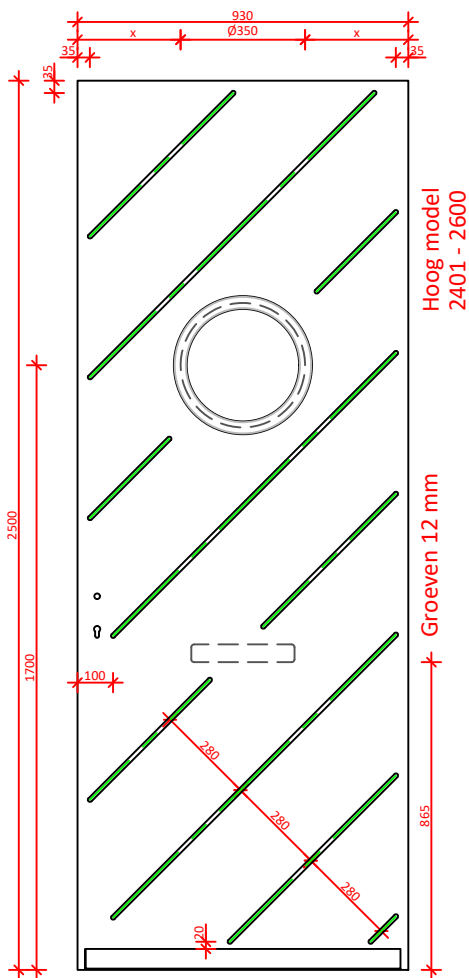
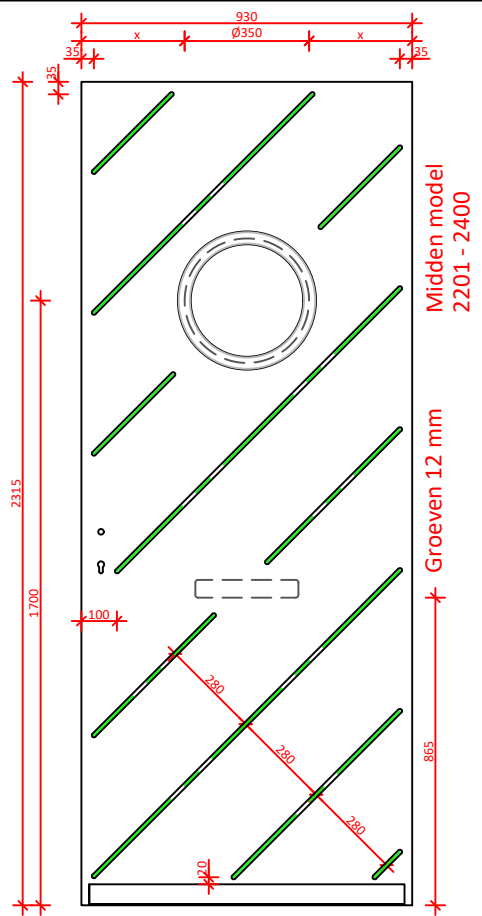
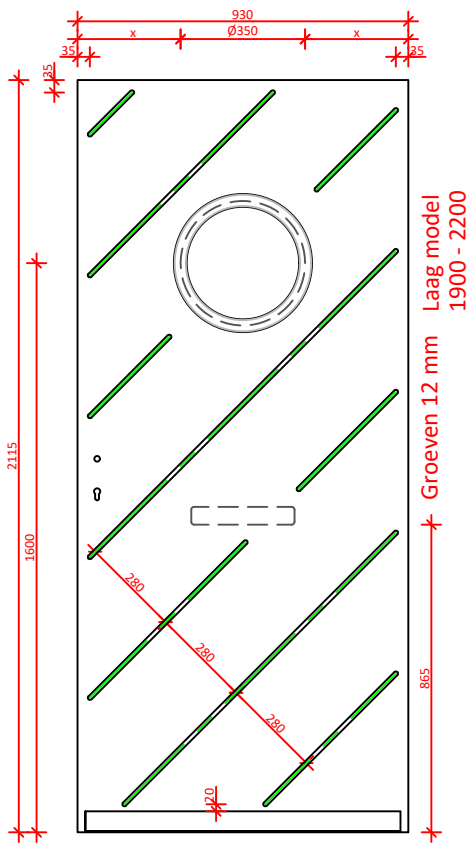

| | | | | | |
|--------|------------|---------------|----------------------|--------|------------|
| DATUM: | GEWIJZIGD: | CALCULATIENR: | TEKENINGNR: 9835N | MODEL: | HOUTSOORT: |
|--------|------------|---------------|----------------------|--------|------------|

| | | | | |
|--|-----------------------------------------------------------|--|--|-------------|
| | KLANT/PROJECT: overzicht modellen 9835N met briefsleuf | | | DCM NUMMER: |
|--|-----------------------------------------------------------|--|--|-------------|

| | | | | |
|-----------|---------|-----------|------------|-----------|
| AANVRAAG: | SCHAAL: | GETEKEND: | LEVERWEEK: | 1.2a P.89 |
|-----------|---------|-----------|------------|-----------|

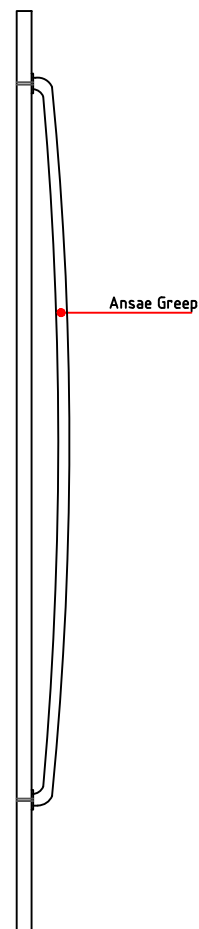
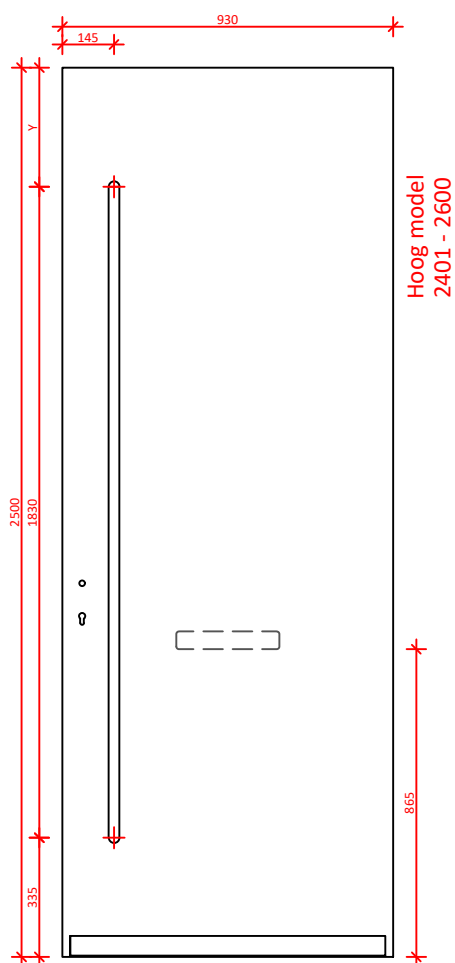
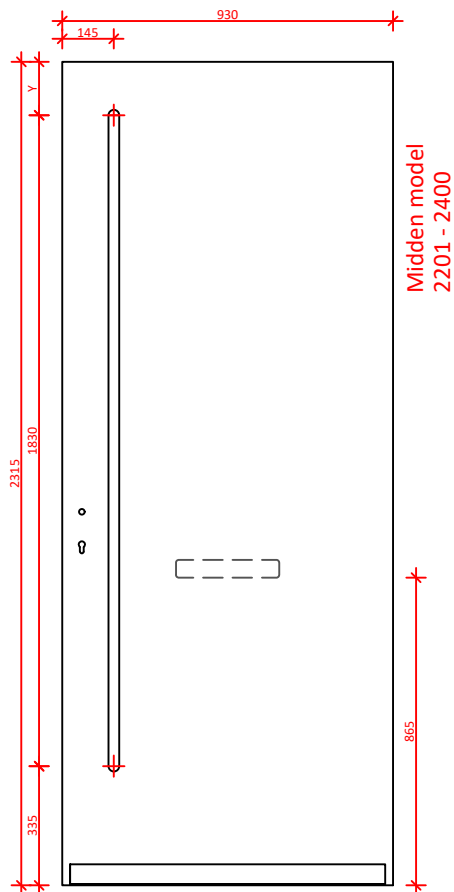
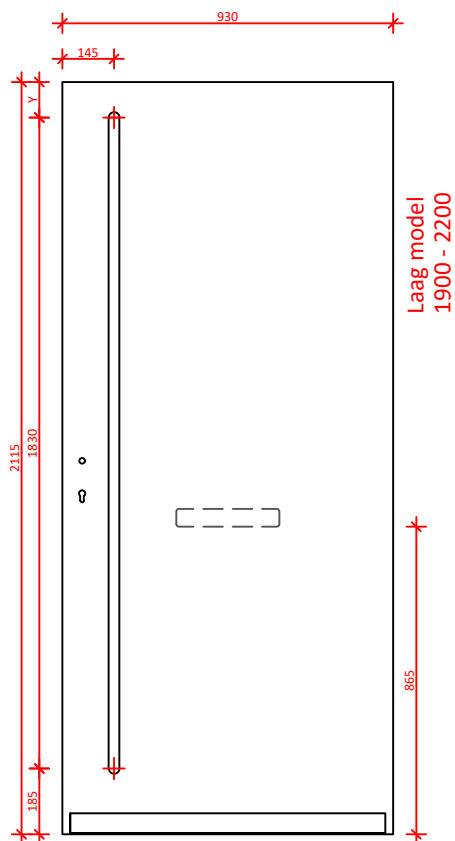

| | | | | | |
|--------|------------|---------------|-------------|----------------|------------|
| DATUM: | GEWIJZIGD: | CALCULATIENR: | TEKENINGNR: | MODEL: 9837 | HOUTSOORT: |
|--------|------------|---------------|-------------|----------------|------------|

| | | | | |
|--|-------------------------------------------|--|--|-------------|
| | KLANT/PROJECT: overzicht modellen 9837 | | | DCM NUMMER: |
|--|-------------------------------------------|--|--|-------------|

| | | | | |
|-----------|---------|-----------------|------------|-----------|
| AANVRAAG: | SCHAAL: | GETEKEND: MN | LEVERWEEK: | 1.2a P.90 |
|-----------|---------|-----------------|------------|-----------|

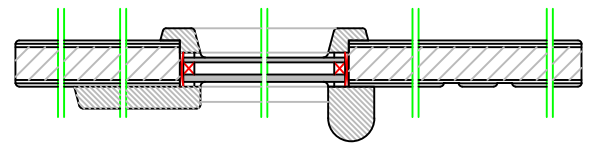
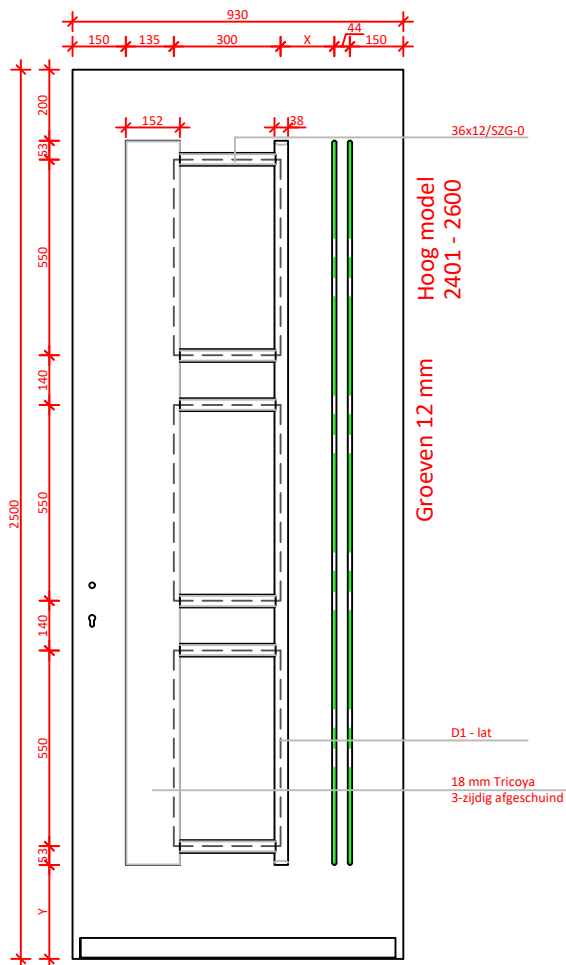
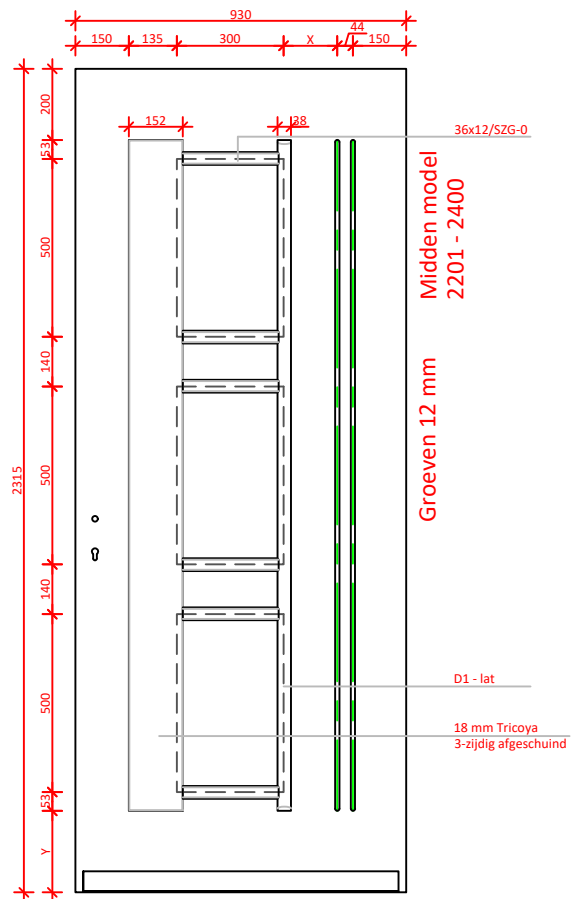
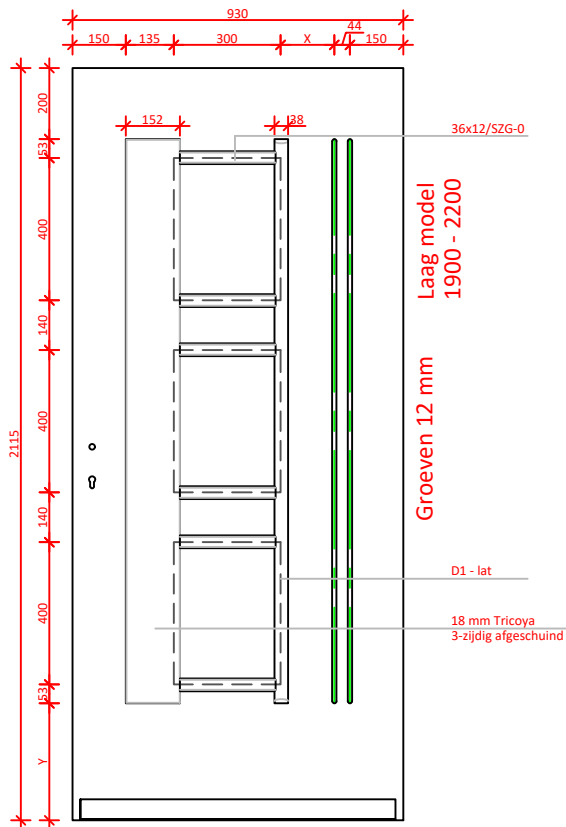

| | | | | | |
|--------|------------|---------------|-------------|-----------------|------------|
| DATUM: | GEWIJZIGD: | CALCULATIENR: | TEKENINGNR: | MODEL: 9843N | HOUTSOORT: |
|--------|------------|---------------|-------------|-----------------|------------|

| | | | | | |
|----------------------------------------------------|--|--|--|-------------|--|
| KLANT/PROJECT: overzicht modellen 9843N L1 - R4 | | | | DCM NUMMER: | |
|----------------------------------------------------|--|--|--|-------------|--|

KEGRO | DEUREN

| | | | |
|-----------|---------|-----------------|-------------------------|
| AANVRAAG: | SCHAAL: | GETEKEND: MN | LEVERWEEK: 1.2a P.91 |
|-----------|---------|-----------------|-------------------------|

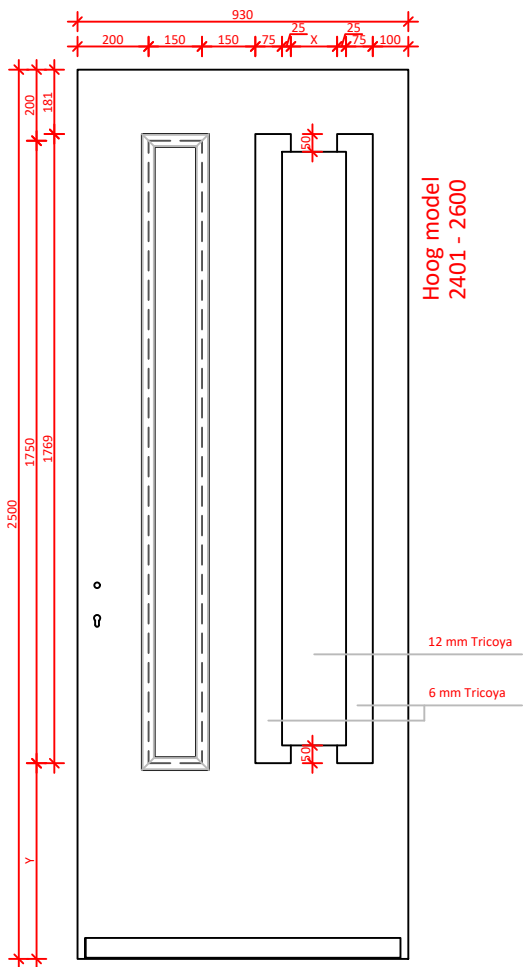
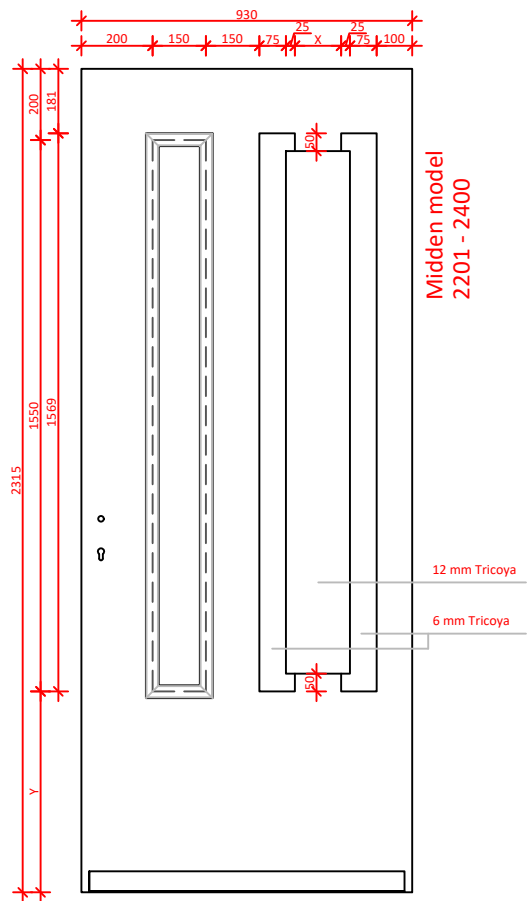
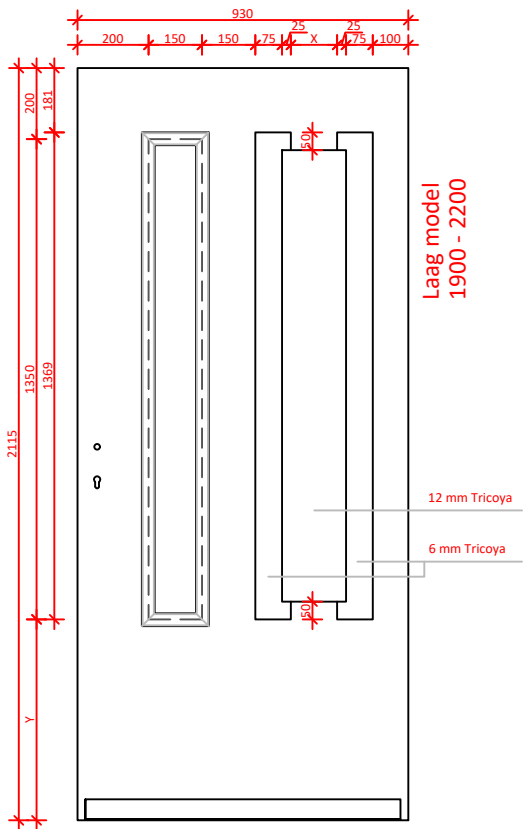

| | | | | | |
|--------|------------|---------------|-------------|-----------------|------------|
| DATUM: | GEWIJZIGD: | CALCULATIENR: | TEKENINGNR: | MODEL: 9844N | HOUTSOORT: |
|--------|------------|---------------|-------------|-----------------|------------|

| | | | | |
|--|----------------------------------------------------|--|--|-------------|
| | KLANT/PROJECT: overzicht modellen 9844N L1 - R4 | | | DCM NUMMER: |
|--|----------------------------------------------------|--|--|-------------|

| | | | |
|-----------|---------|-----------------|-------------------------|
| AANVRAAG: | SCHAAL: | GETEKEND: MN | LEVERWEEK: 1.2a P.92 |
|-----------|---------|-----------------|-------------------------|

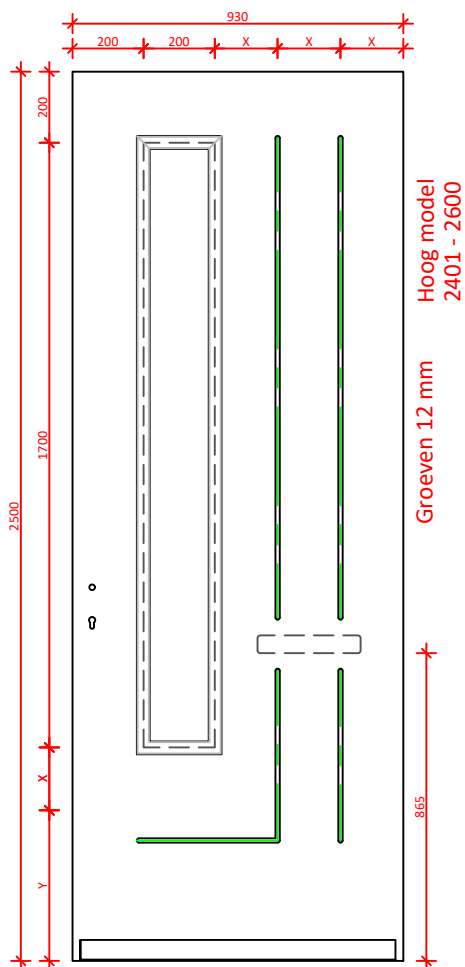
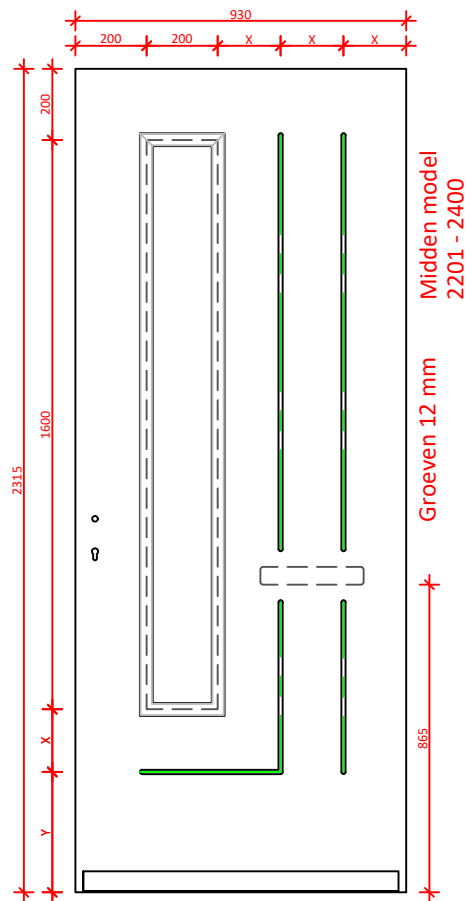
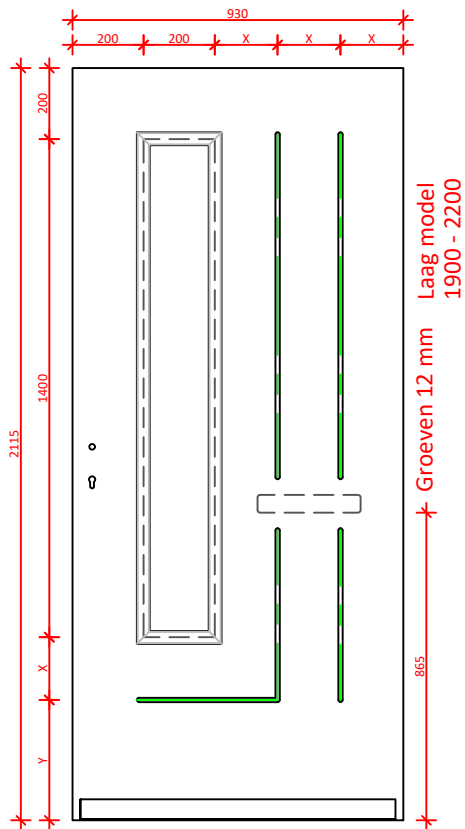

| | | | | | |
|--------|------------|---------------|-------------|-----------------|------------|
| DATUM: | GEWIJZIGD: | CALCULATIENR: | TEKENINGNR: | MODEL: 9846N | HOUTSOORT: |
|--------|------------|---------------|-------------|-----------------|------------|

| | | | | |
|--|-----------------------------------------------------------|--|--|-------------|
| | KLANT/PROJECT: overzicht modellen 9846N met briefsleuf | | | DCM NUMMER: |
|--|-----------------------------------------------------------|--|--|-------------|

| | | | | |
|-----------|---------|-----------------|------------|-----------|
| AANVRAAG: | SCHAAL: | GETEKEND: MN | LEVERWEEK: | 1.2a P.93 |
|-----------|---------|-----------------|------------|-----------|

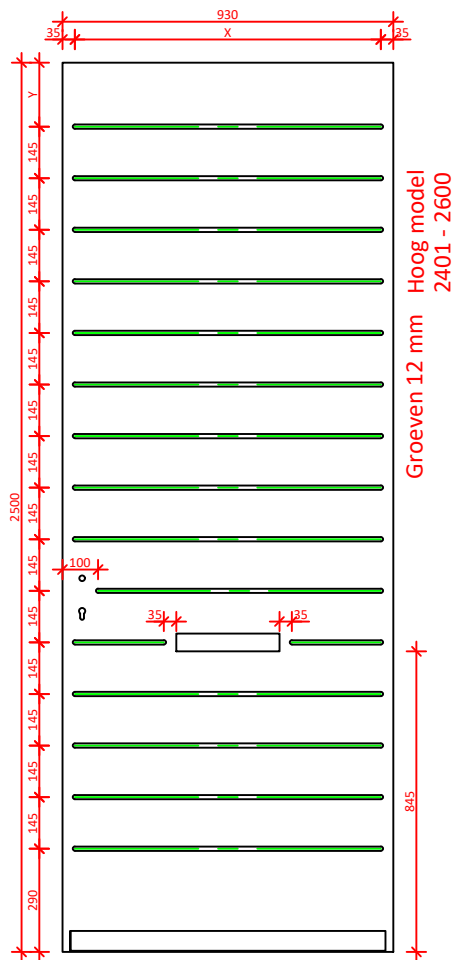
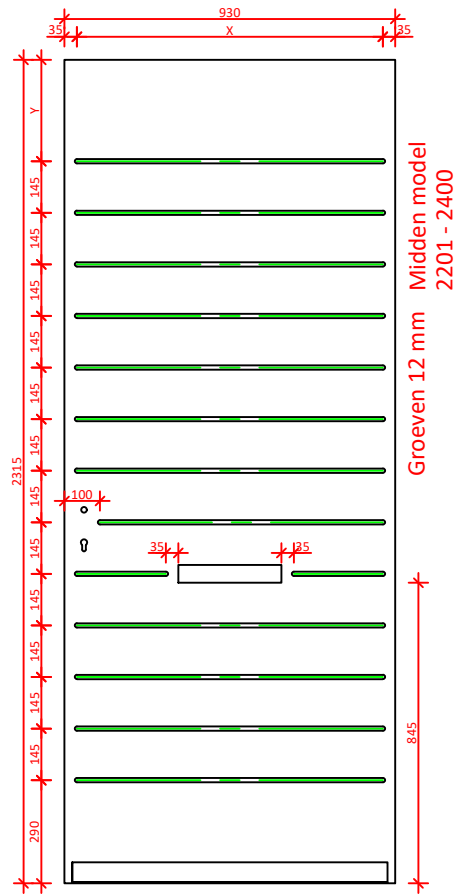
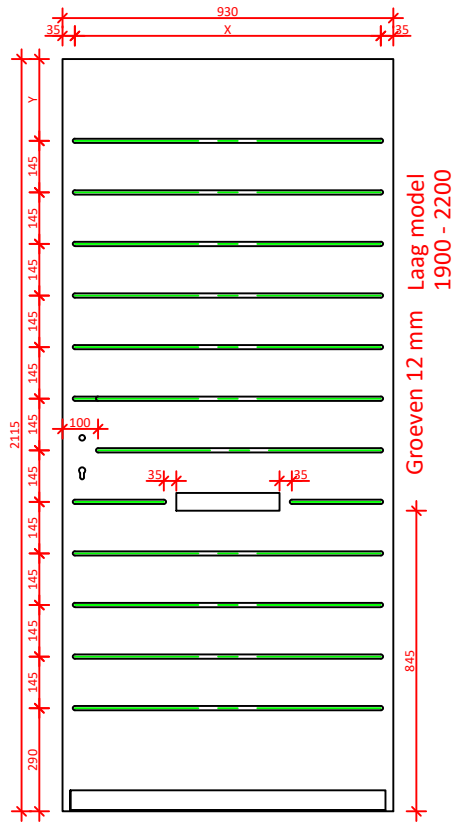

Rekening houden met slothoogte bij senioren schild

| | | | | | |
|--------|------------|---------------|-------------|-----------------|------------|
| DATUM: | GEWIJZIGD: | CALCULATIENR: | TEKENINGNR: | MODEL: 9847N | HOUTSOORT: |
|--------|------------|---------------|-------------|-----------------|------------|

| | | | | |
|--|-------------------------------------------------------|--|--|-------------|
| | KLANT/PROJECT: overzicht modellen 9847N briefsleuf | | | DCM NUMMER: |
|--|-------------------------------------------------------|--|--|-------------|

| | | | | |
|-----------|---------|-----------------|------------|-----------|
| AANVRAAG: | SCHAAL: | GETEKEND: MN | LEVERWEEK: | 1.2a P.94 |
|-----------|---------|-----------------|------------|-----------|

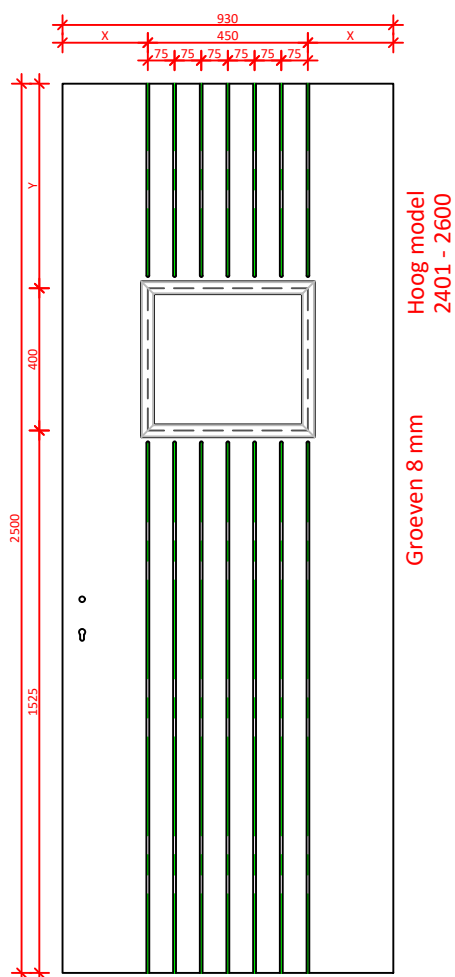
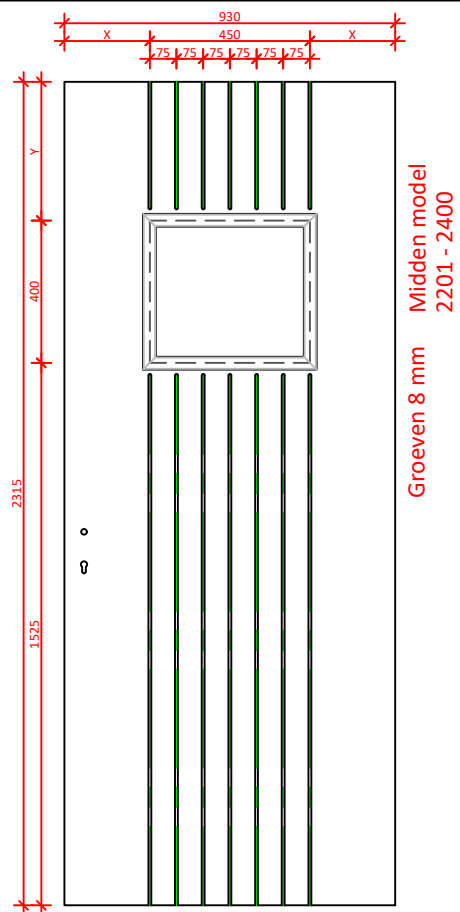
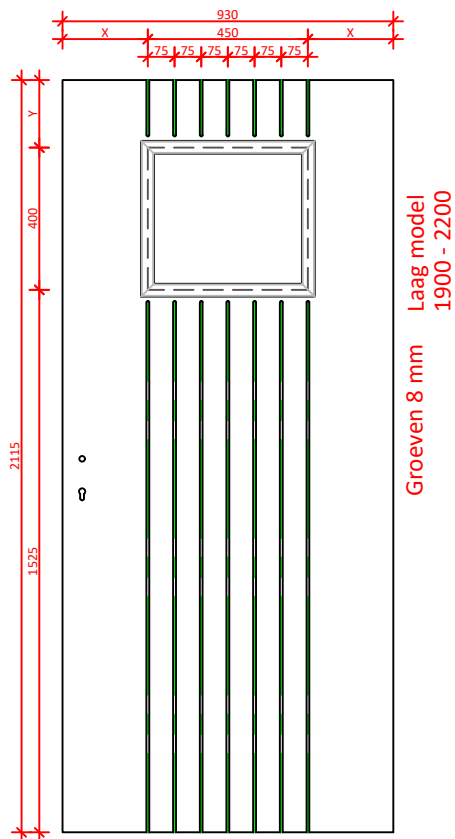

| | | | | | |
|--------|------------|---------------|-------------|-----------------|------------|
| DATUM: | GEWIJZIGD: | CALCULATIENR: | TEKENINGNR: | MODEL: 9848N | HOUTSOORT: |
|--------|------------|---------------|-------------|-----------------|------------|

| | | | | |
|--|-------------------------------------------------------|--|--|-------------|
| | KLANT/PROJECT: overzicht modellen 9848N briefsleuf | | | DCM NUMMER: |
|--|-------------------------------------------------------|--|--|-------------|

| | | | |
|-----------|---------|-----------------|-------------------------|
| AANVRAAG: | SCHAAL: | GETEKEND: MN | LEVERWEEK: 1.2a P.95 |
|-----------|---------|-----------------|-------------------------|

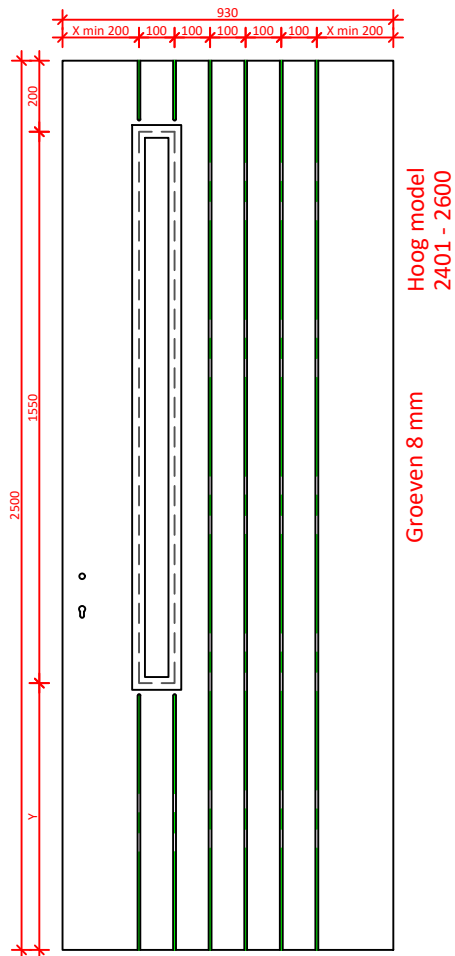
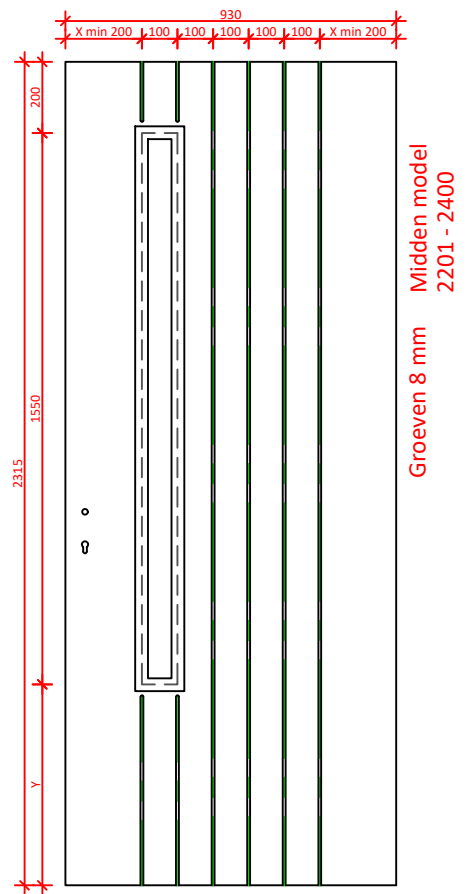
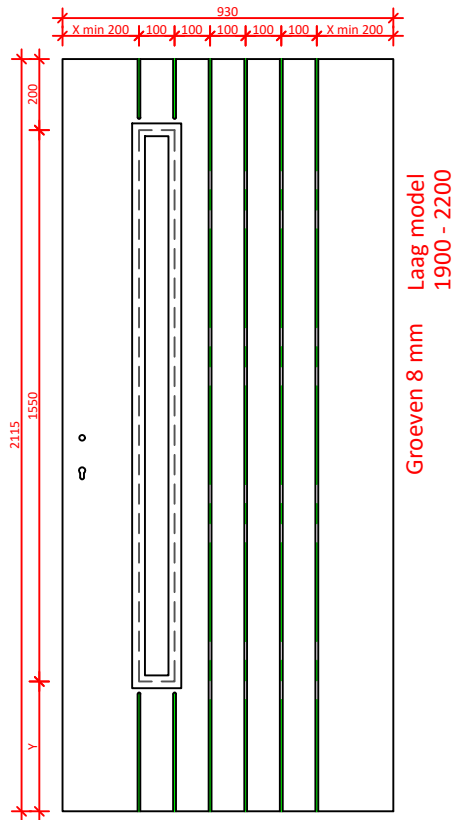

| | | | | | |
|--------|------------|---------------|-------------|-----------------|------------|
| DATUM: | GEWIJZIGD: | CALCULATIENR: | TEKENINGNR: | MODEL: 9849N | HOUTSOORT: |
|--------|------------|---------------|-------------|-----------------|------------|

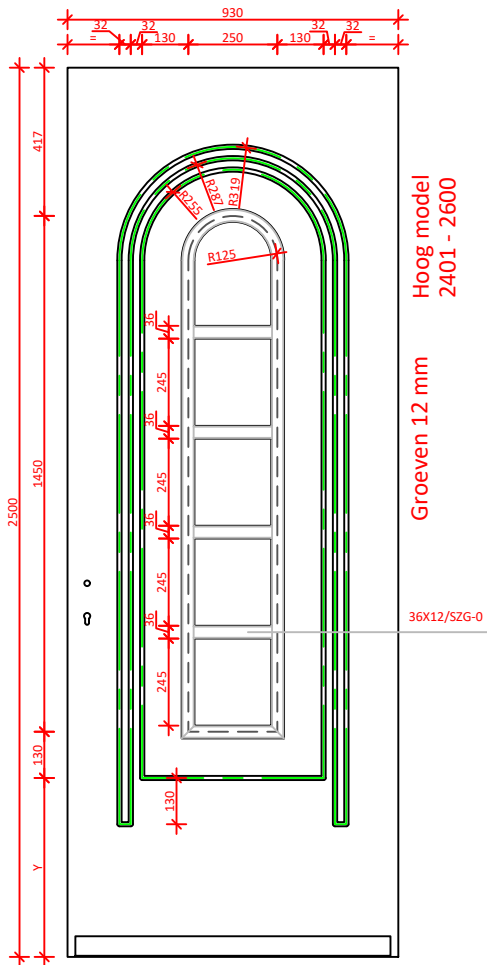
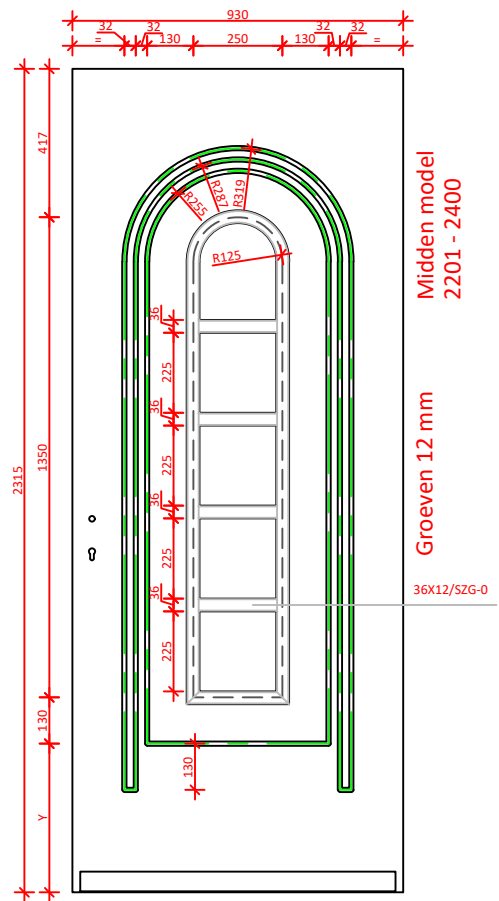
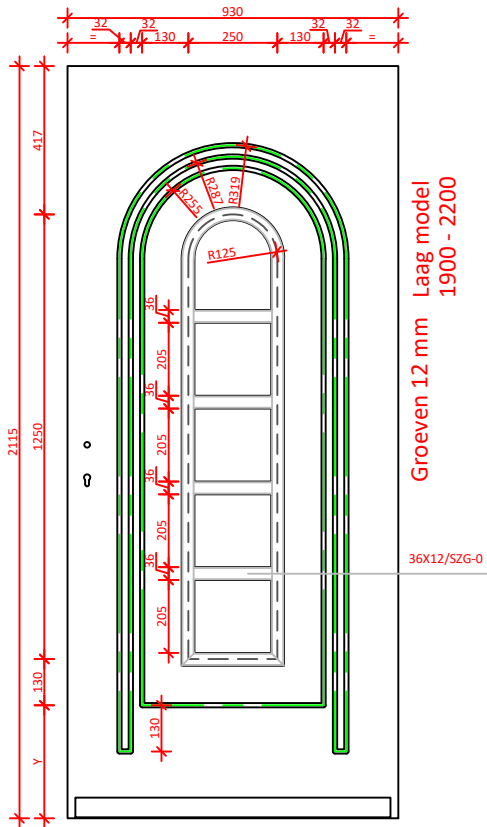

| | | | | | |
|--------|------------|---------------|----------------------|-----------------|------------|
| DATUM: | GEWIJZIGD: | CALCULATIENR: | TEKENINGNR: 9860N | MODEL: 9860N | HOUTSOORT: |
|--------|------------|---------------|----------------------|-----------------|------------|

| | | | | |
|--|-------------------------------------------------------|--|--|-------------|
| | KLANT/PROJECT: overzicht modellen 9860N briefsleuf | | | DCM NUMMER: |
|--|-------------------------------------------------------|--|--|-------------|

| | | | | |
|-----------|---------|-----------------|------------|-----------|
| AANVRAAG: | SCHAAL: | GETEKEND: MN | LEVERWEEK: | 1.2a P.97 |
|-----------|---------|-----------------|------------|-----------|

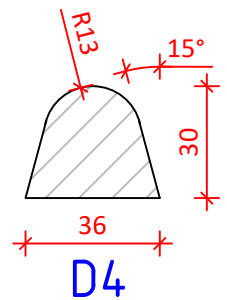
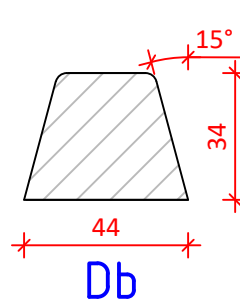
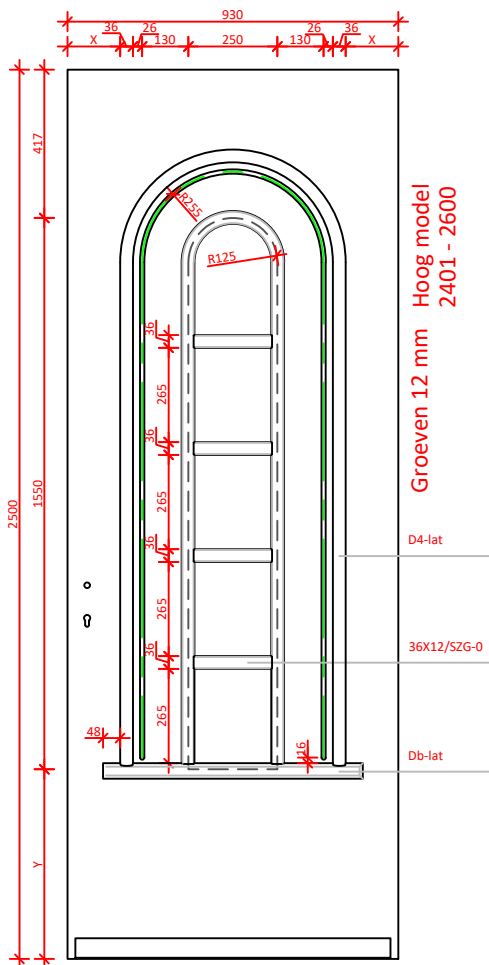
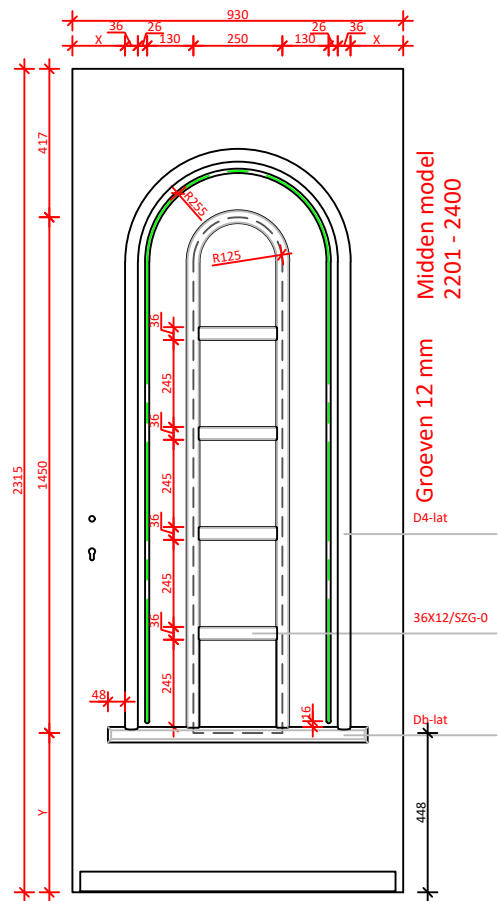
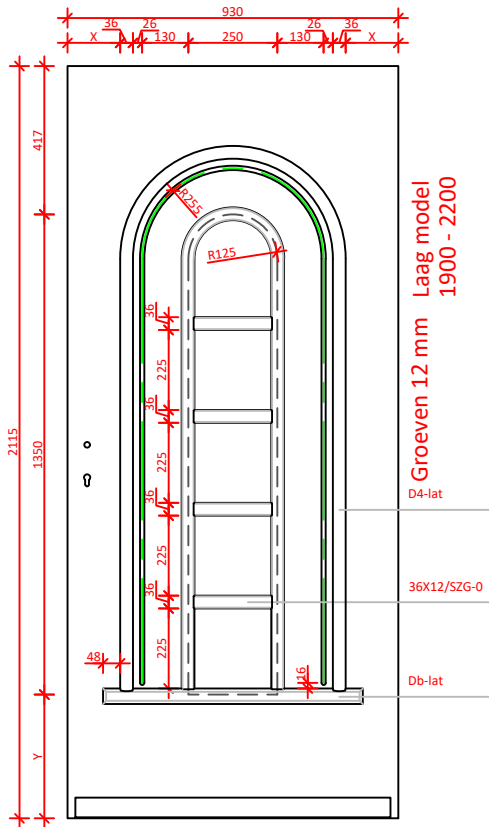

| | | | | | |
|--------|------------|---------------|-------------|-----------------|------------|
| DATUM: | GEWIJZIGD: | CALCULATIENR: | TEKENINGNR: | MODEL: 9861N | HOUTSOORT: |
|--------|------------|---------------|-------------|-----------------|------------|

| | | | | |
|-----------------------|--------------------------------------------|--|--|-------------|
| KEGRO DEUREN | KLANT/PROJECT: overzicht modellen 9861N | | | DCM NUMMER: |
|-----------------------|--------------------------------------------|--|--|-------------|

| | | | |
|-----------|---------|-----------------|-------------------------|
| AANVRAAG: | SCHAAL: | GETEKEND: MN | LEVERWEEK: 1.2a P.98 |
|-----------|---------|-----------------|-------------------------|

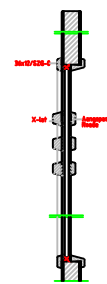
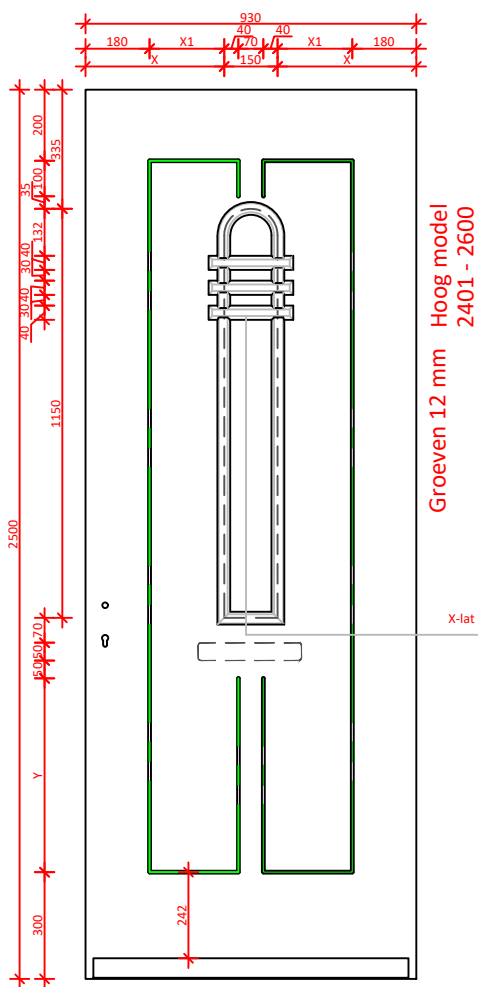
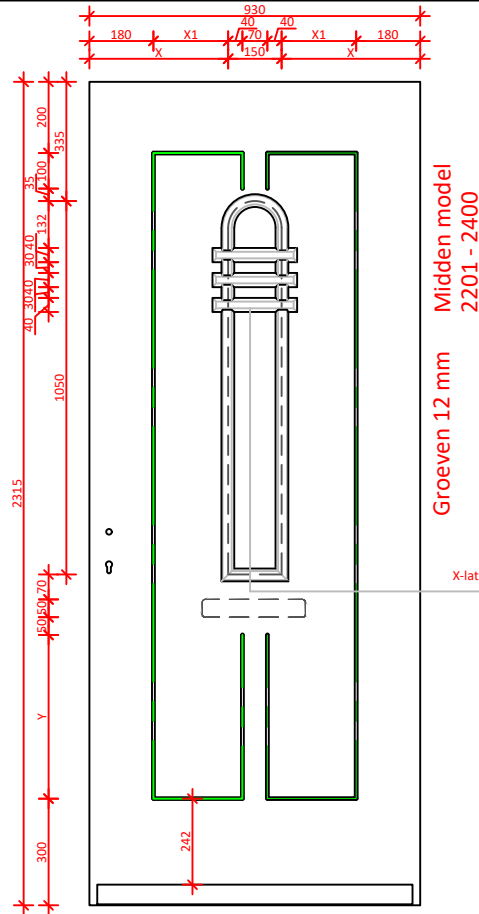
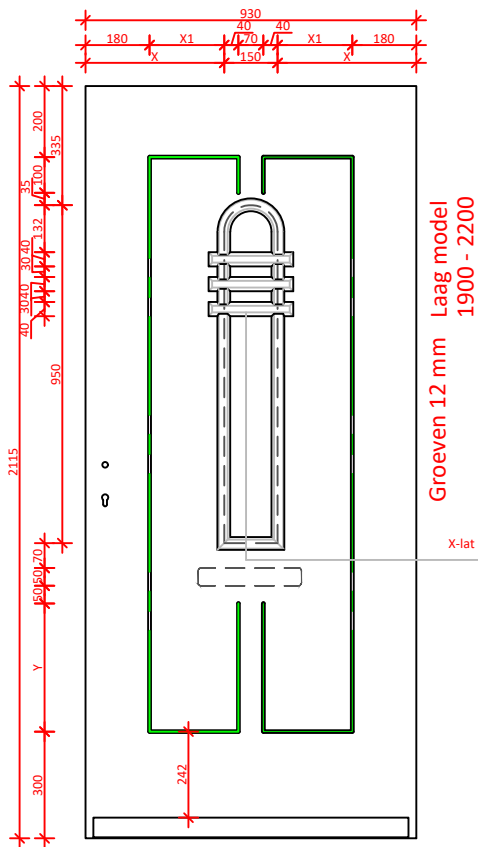

| | | | | | |
|--------|------------|---------------|-------------|-----------------|------------|
| DATUM: | GEWIJZIGD: | CALCULATIENR: | TEKENINGNR: | MODEL: 9862N | HOUTSOORT: |
|--------|------------|---------------|-------------|-----------------|------------|

| | | | | |
|------------------------------------------------------------------------------------|-------------------------------------------------------|--|--|-------------|
|  | KLANT/PROJECT: overzicht modellen 9862N briefsleuf | | | DCM NUMMER: |
|------------------------------------------------------------------------------------|-------------------------------------------------------|--|--|-------------|

| | | | |
|-----------|---------|-----------------|-------------------------|
| AANVRAAG: | SCHAAL: | GETEKEND: MN | LEVERWEEK: 1.2a P.99 |
|-----------|---------|-----------------|-------------------------|

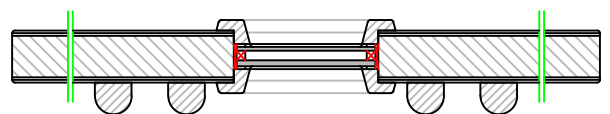
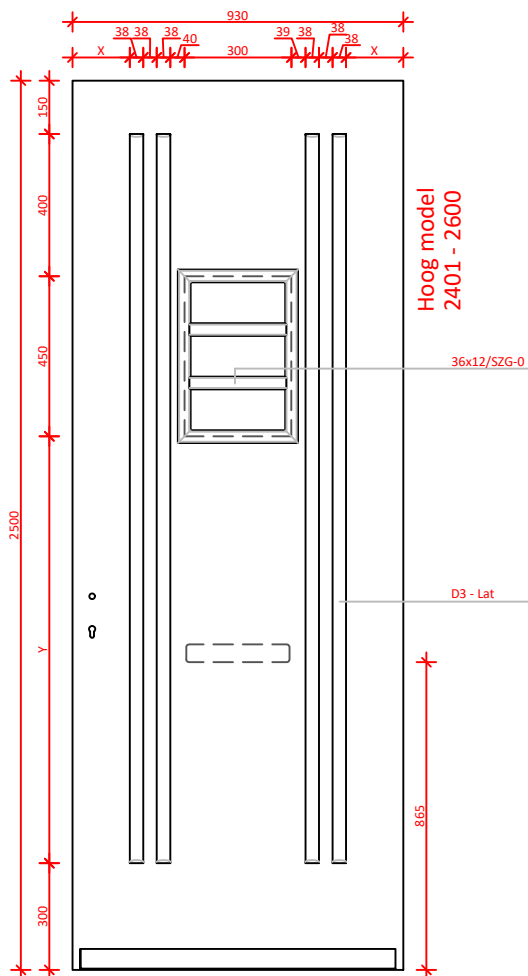
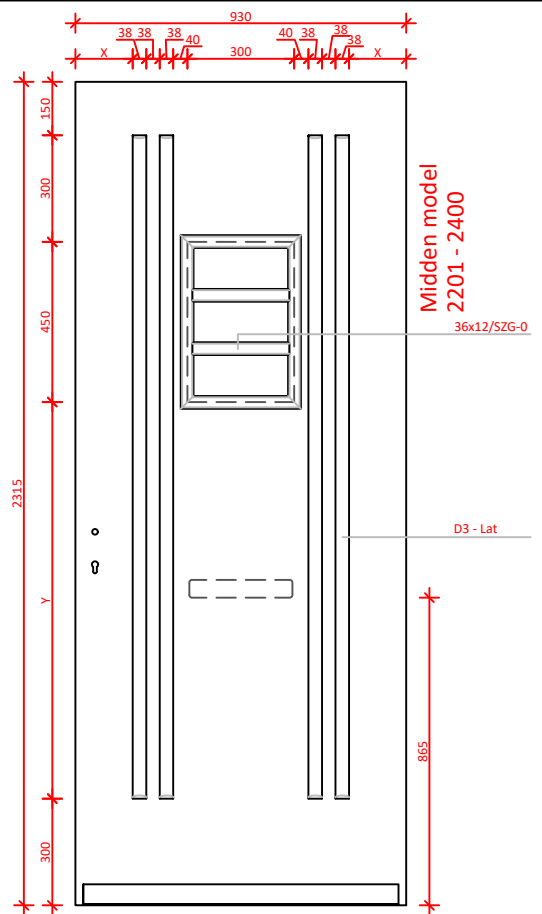
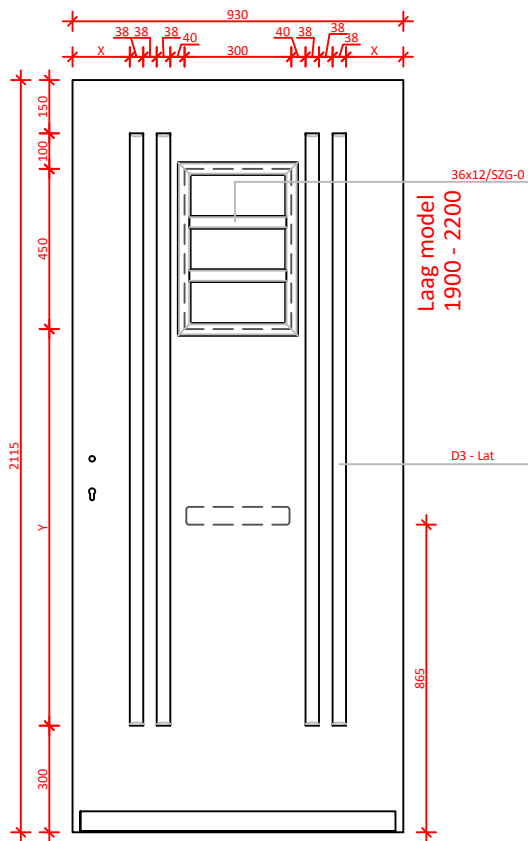

| | | | | | |
|--------|------------|---------------|-------------|-----------------|------------|
| DATUM: | GEWIJZIGD: | CALCULATIENR: | TEKENINGNR: | MODEL: 9863N | HOUTSOORT: |
|--------|------------|---------------|-------------|-----------------|------------|

| | | | | |
|------------------------------------------------------------------------------------|--------------------------------------------|--|--|-------------|
|  | KLANT/PROJECT: overzicht modellen 9863N | | | DCM NUMMER: |
|------------------------------------------------------------------------------------|--------------------------------------------|--|--|-------------|

| | | | | |
|-----------|---------|-----------------|------------|------------|
| AANVRAAG: | SCHAAL: | GETEKEND: MN | LEVERWEEK: | 1.2a P.100 |
|-----------|---------|-----------------|------------|------------|

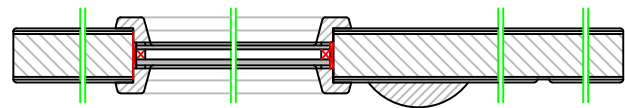
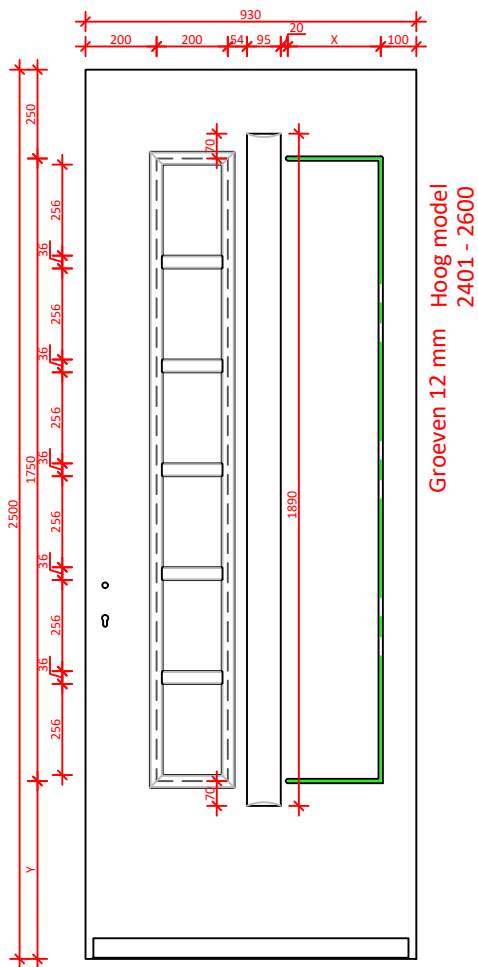
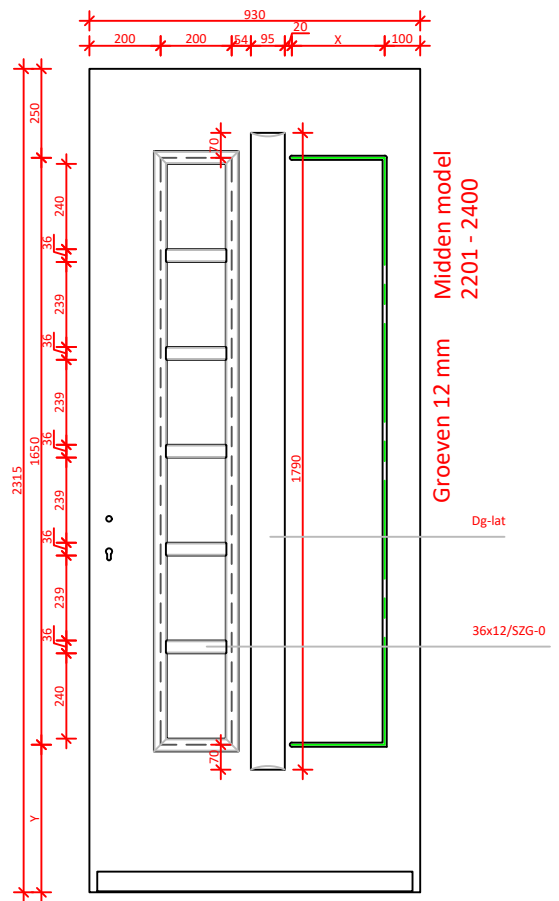
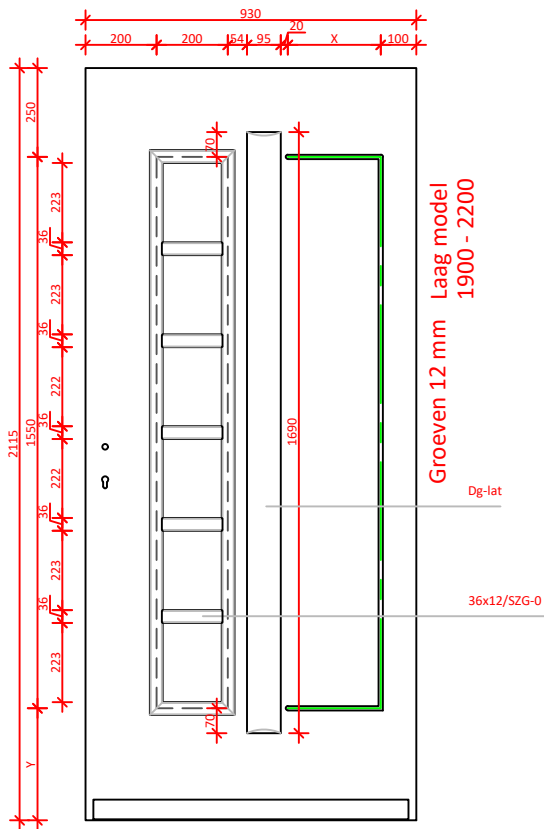

| | | | | | |
|--------|------------|---------------|-------------|-----------------|------------|
| DATUM: | GEWIJZIGD: | CALCULATIENR: | TEKENINGNR: | MODEL: 9864N | HOUTSOORT: |
|--------|------------|---------------|-------------|-----------------|------------|

| | | | | |
|--|--------------------------------------------|--|--|-------------|
| | KLANT/PROJECT: overzicht modellen 9864N | | | DCM NUMMER: |
|--|--------------------------------------------|--|--|-------------|

| | | | |
|-----------|---------|-----------------|--------------------------|
| AANVRAAG: | SCHAAL: | GETEKEND: MN | LEVERWEEK: 1.2a P.101 |
|-----------|---------|-----------------|--------------------------|

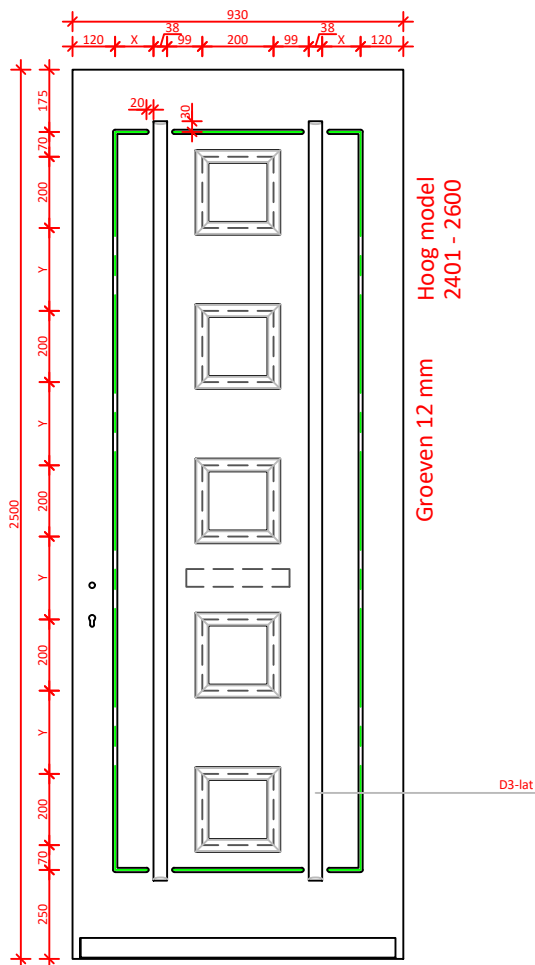
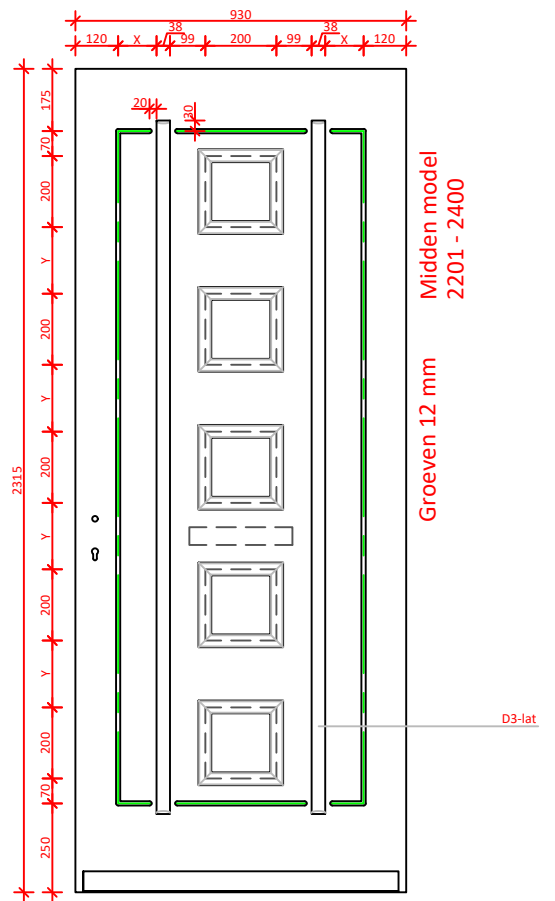
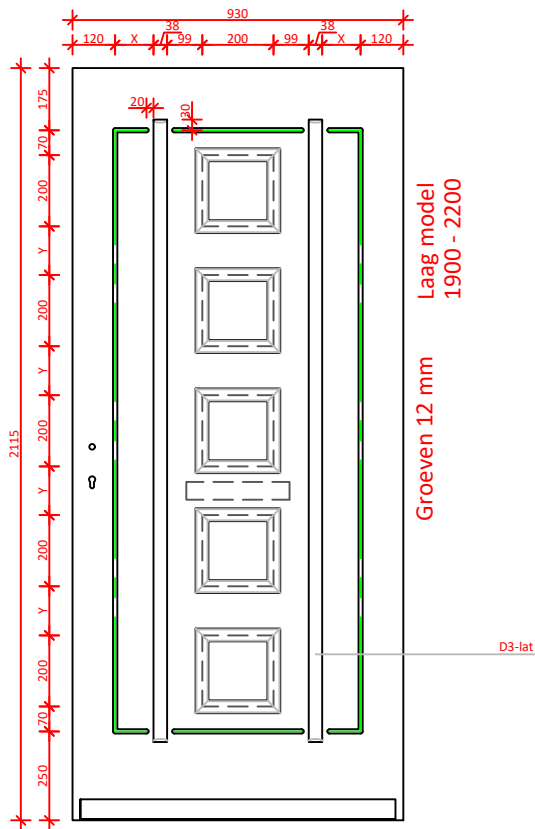

| | | | | | |
|--------|------------|---------------|-------------|-----------------|------------|
| DATUM: | GEWIJZIGD: | CALCULATIENR: | TEKENINGNR: | MODEL: 9865N | HOUTSOORT: |
|--------|------------|---------------|-------------|-----------------|------------|

| | | | | |
|--|--------------------------------------------|--|--|-------------|
| | KLANT/PROJECT: overzicht modellen 9865N | | | DCM NUMMER: |
|--|--------------------------------------------|--|--|-------------|

| | | | |
|-----------|---------|-----------------|--------------------------|
| AANVRAAG: | SCHAAL: | GETEKEND: MN | LEVERWEEK: 1.2a P.102 |
|-----------|---------|-----------------|--------------------------|

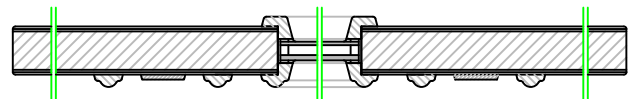
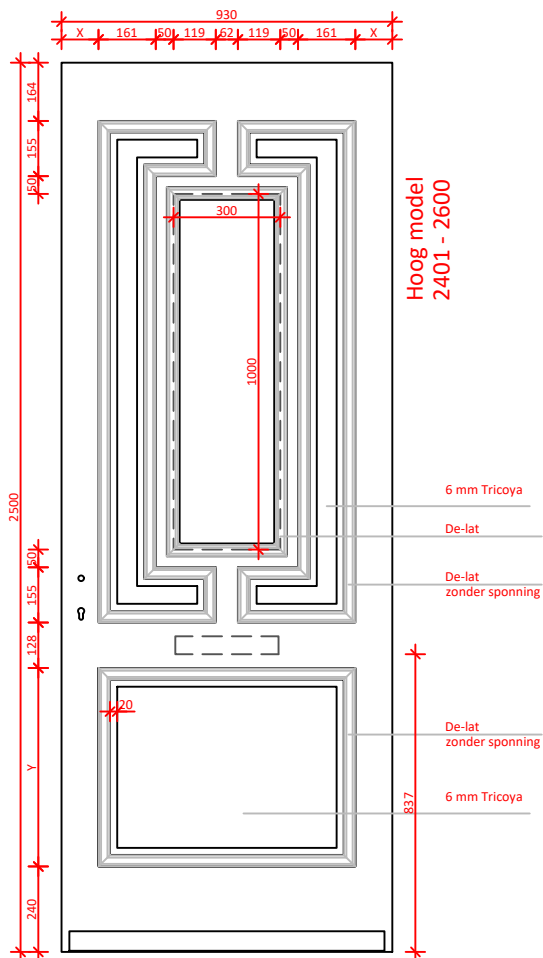
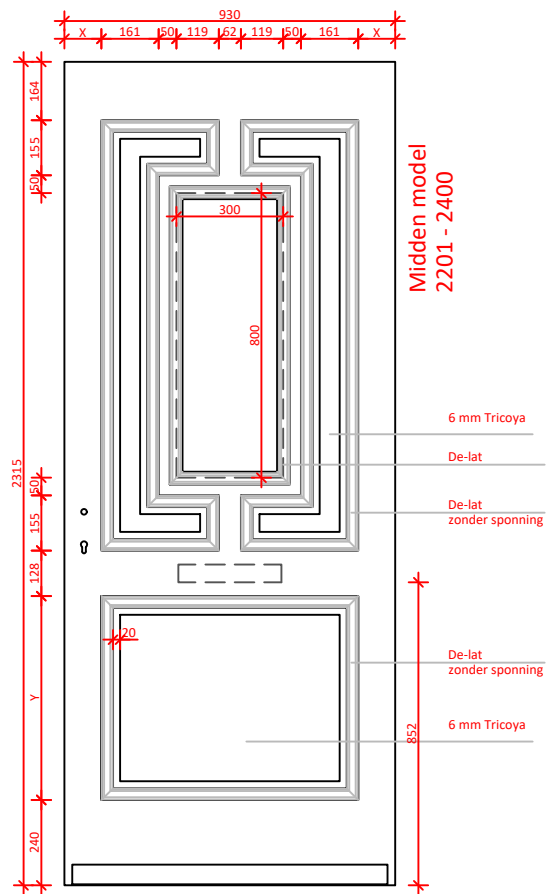
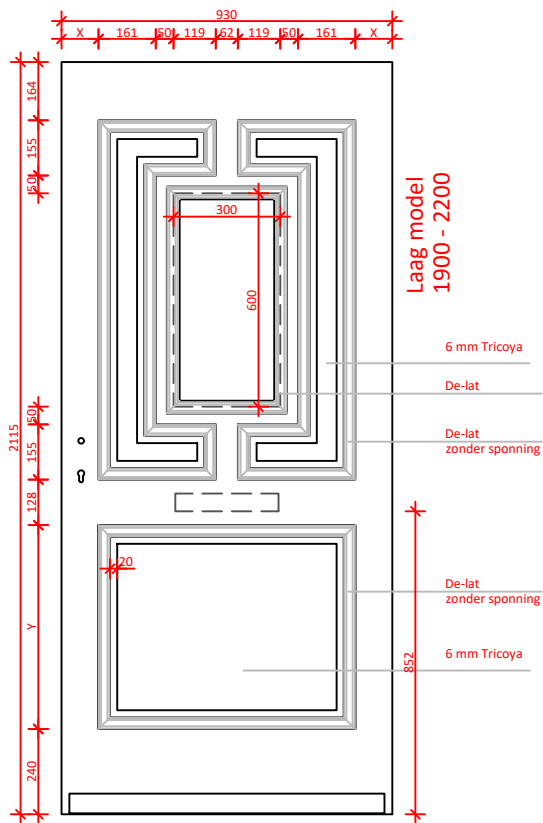

| | | | | | |
|--------|------------|---------------|----------------------|-----------------|------------|
| DATUM: | GEWIJZIGD: | CALCULATIENR: | TEKENINGNR: 9866N | MODEL: 9866N | HOUTSOORT: |
|--------|------------|---------------|----------------------|-----------------|------------|

| | | | | |
|-----------------------|--------------------------------------------|--|--|-------------|
| KEGRO DEUREN | KLANT/PROJECT: overzicht modellen 9866N | | | DCM NUMMER: |
|-----------------------|--------------------------------------------|--|--|-------------|

| | | | |
|-----------|---------|-----------------|--------------------------|
| AANVRAAG: | SCHAAL: | GETEKEND: MN | LEVERWEEK: 1.2a P.103 |
|-----------|---------|-----------------|--------------------------|

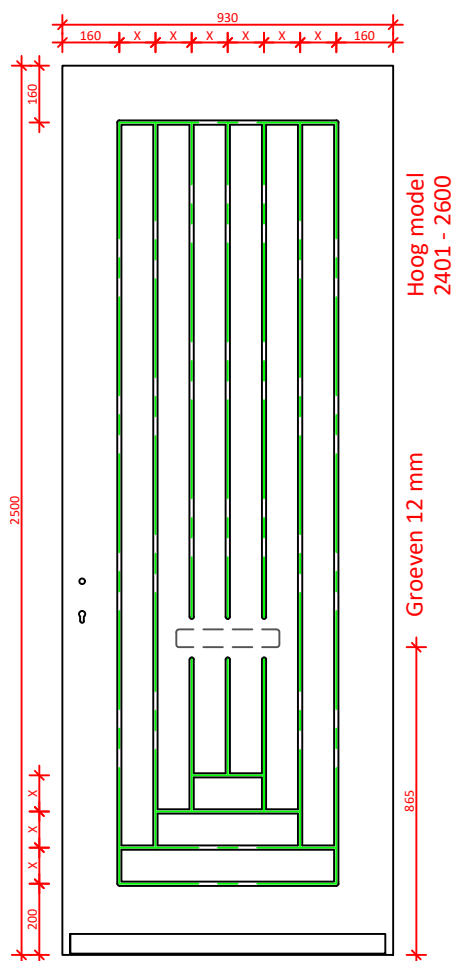
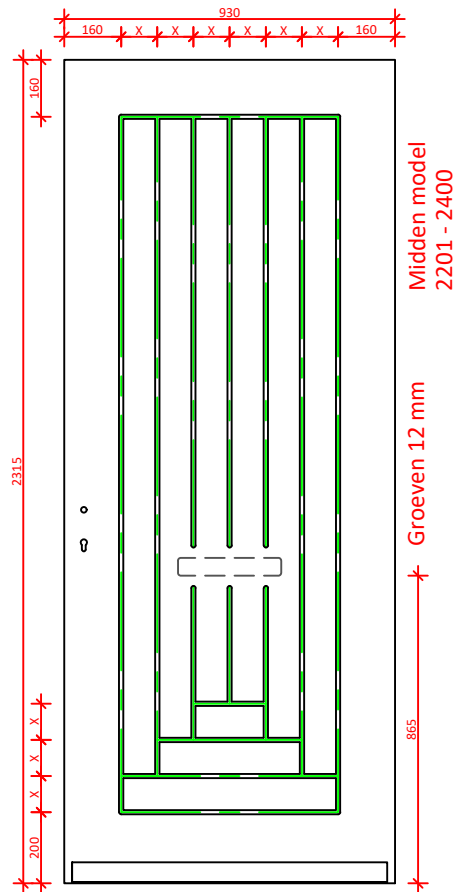
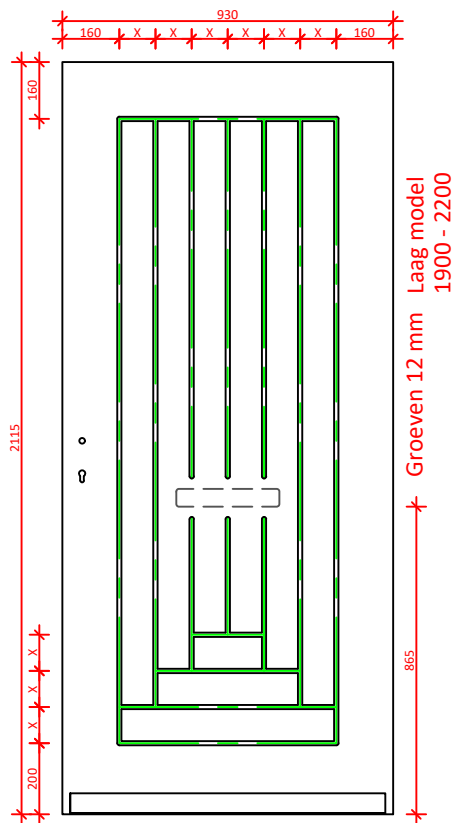

| | | | | | |
|--------|------------|---------------|-------------|----------------|------------|
| DATUM: | GEWIJZIGD: | CALCULATIENR: | TEKENINGNR: | MODEL: 9867 | HOUTSOORT: |
|--------|------------|---------------|-------------|----------------|------------|

| | | | | |
|-----------------------|----------------------------------------------------------|--|--|-------------|
| KEGRO DEUREN | KLANT/PROJECT: overzicht modellen 9867 met briefsleuf | | | DCM NUMMER: |
|-----------------------|----------------------------------------------------------|--|--|-------------|

| | | | |
|-----------|---------|-----------------|--------------------------|
| AANVRAAG: | SCHAAL: | GETEKEND: MN | LEVERWEEK: 1.2a P.104 |
|-----------|---------|-----------------|--------------------------|

dé makers van buitendeuren

BEZOEKADRES
Industrieweg 25
6562 AP Groesbeek
+31 (0)24 399 95 55
info@kegro.nl
www.kegro.nl

SOCIAL MEDIA
 KegroDeuren
 @kegrodeuren
 kegro-Deuren

KEGRO | DEUREN