

## 1.2A Deuropbouw en maatvoering Vlakke Deuren

Kegro Deuren hanteert 1 modelnummer voor de afmetingen hoog, midden en laag. De Glasmaat staat hierbij vast.

Uitvoering in 3 hoogtes:

- <2200mm = Laag model
- 2201 – 2400mm = Midden model
- >2401mm = Hoog model
- De minimale maat is veelal 1900mm

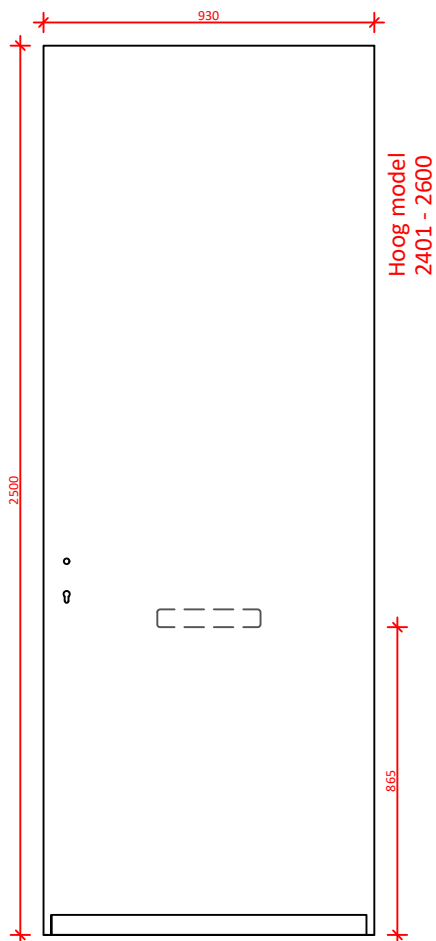
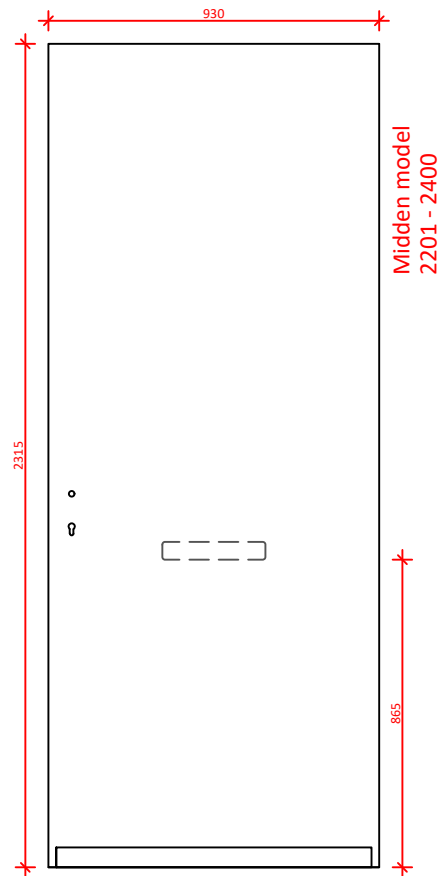
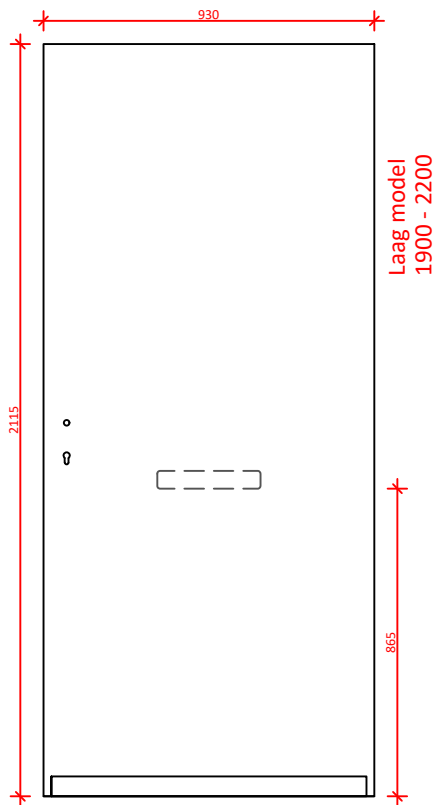

DATUM:	GEWIJZIGD:	CALCULATIENR:	TEKENINGNR: 9101	MODEL:	HOUTSOORT:
--------	------------	---------------	---------------------	--------	------------

<b>KEGRO   DEUREN</b>	KLANT/PROJECT: overzicht modellen 9101 L1 - R4			DCM NUMMER:	
-----------------------	---	--	--	-------------	--

AANVRAAG:	SCHAAL:	GETEKEND: MN	LEVERWEEK:	1.2a P.2
-----------	---------	-----------------	------------	----------

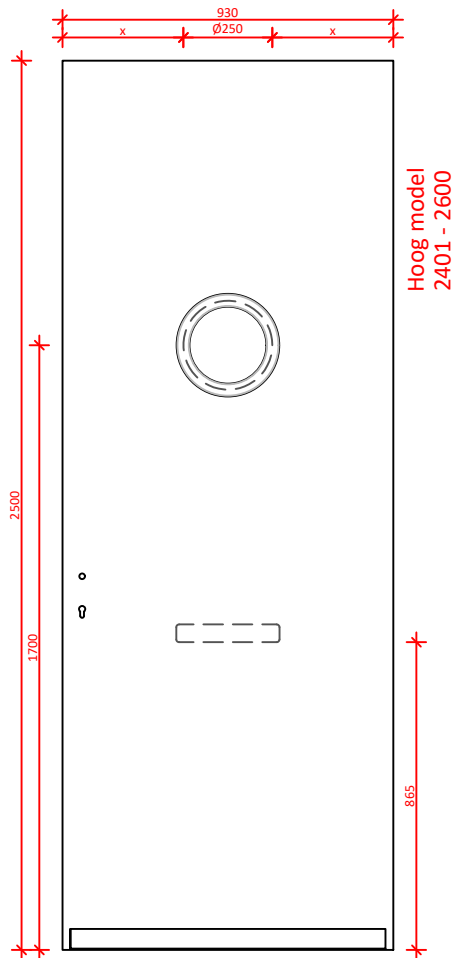
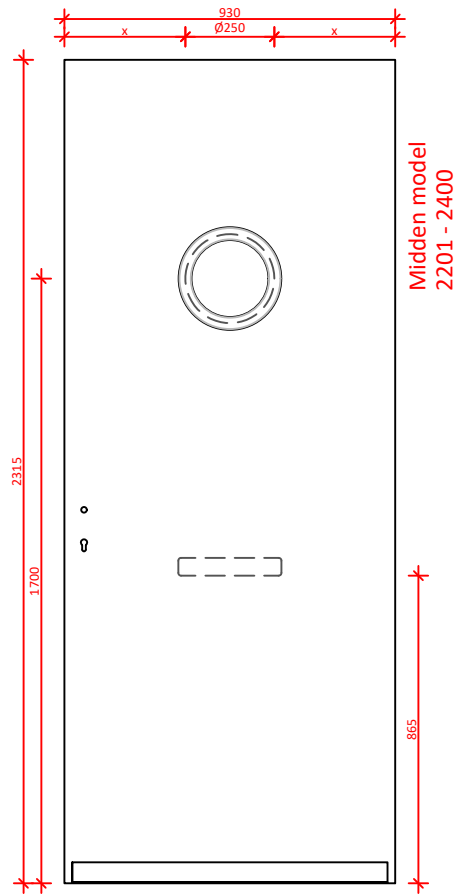
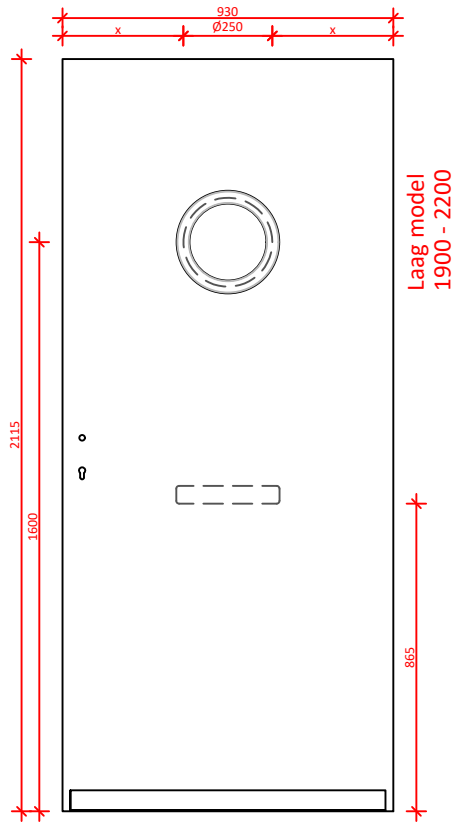

DATUM:	GEWIJZIGD:	CALCULATIENR:	TEKENINGNR:	MODEL: 9152N	HOUTSOORT:
--------	------------	---------------	-------------	-----------------	------------

<b>KEGRO   DEUREN</b>	KLANT/PROJECT: overzicht modellen 9152N			DCM NUMMER:
-----------------------	--	--	--	-------------

AANVRAAG:	SCHAAL:	GETEKEND:	LEVERWEEK:	1.2a P.3
-----------	---------	-----------	------------	----------

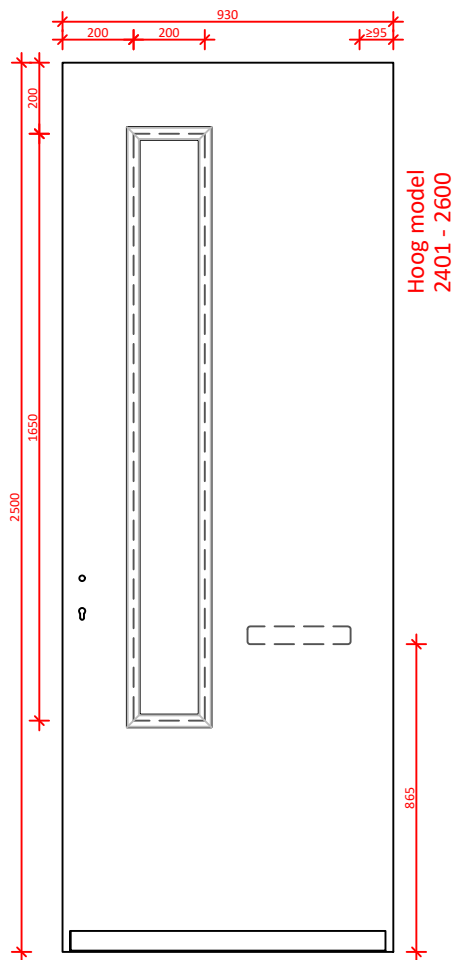
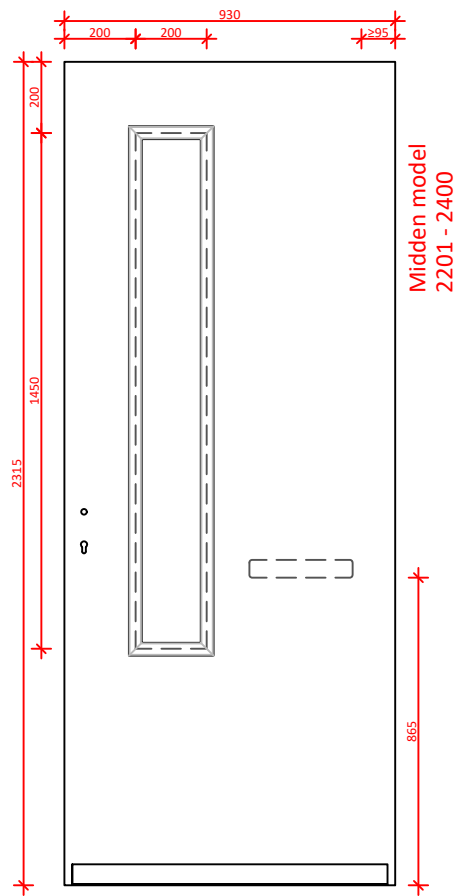
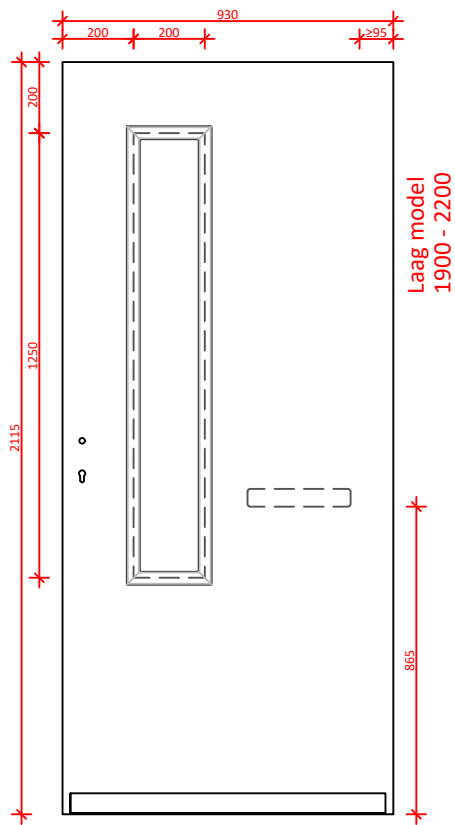



DATUM:	GEWIJZIGD:	CALCULATIENR:	TEKENINGNR:	MODEL: 9153N	HOUTSOORT:
--------	------------	---------------	-------------	-----------------	------------

	KLANT/PROJECT: overzicht modellen 9153N L1 - R4			DCM NUMMER:
--	--	--	--	-------------

AANVRAAG:	SCHAAL:	GETEKEND: MN	LEVERWEEK:	1.2a P.4
-----------	---------	-----------------	------------	----------

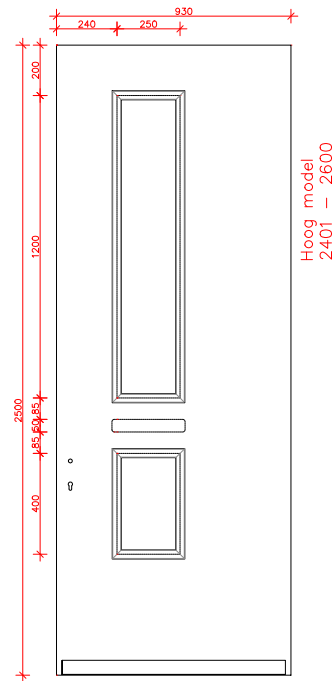
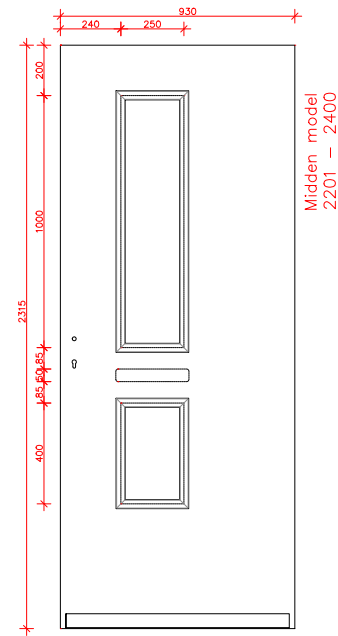
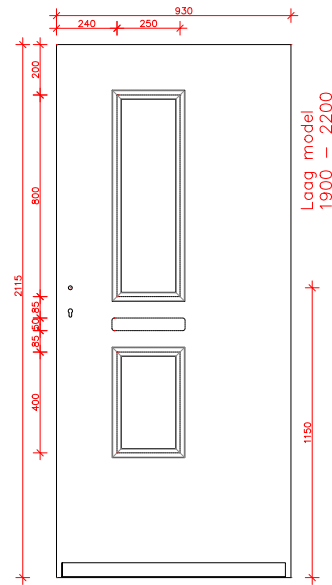



DATUM:	GEWIJZIGD:	CALCULATIENR:	TEKENINGNR: 9154N	MODEL: 9154N	HOUTSOORT:
			KLANT/PROJECT: overzicht modellen 9154N L1 - R4		DCM NUMMER:
			AANVRAAG:	SCHAAL:	GETEKEND: MN

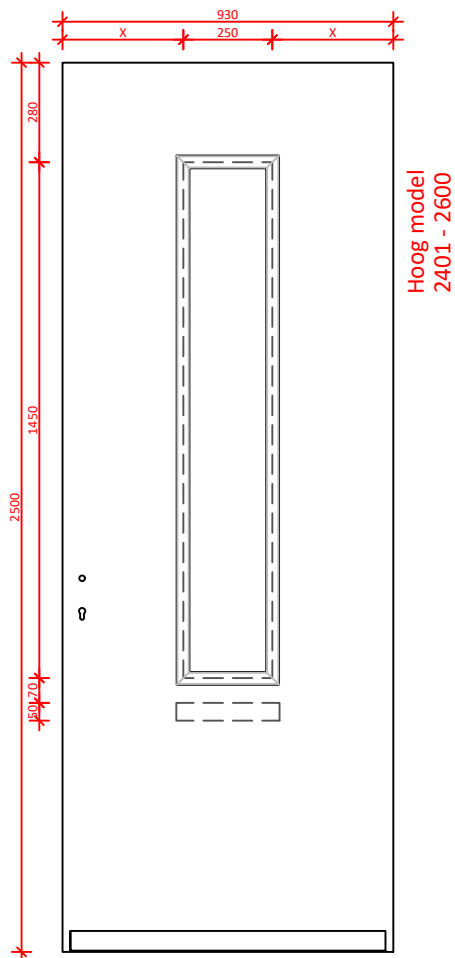
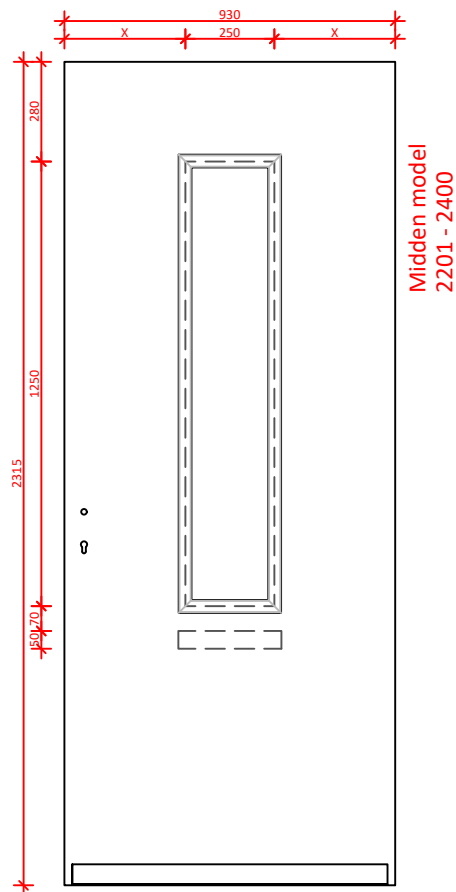
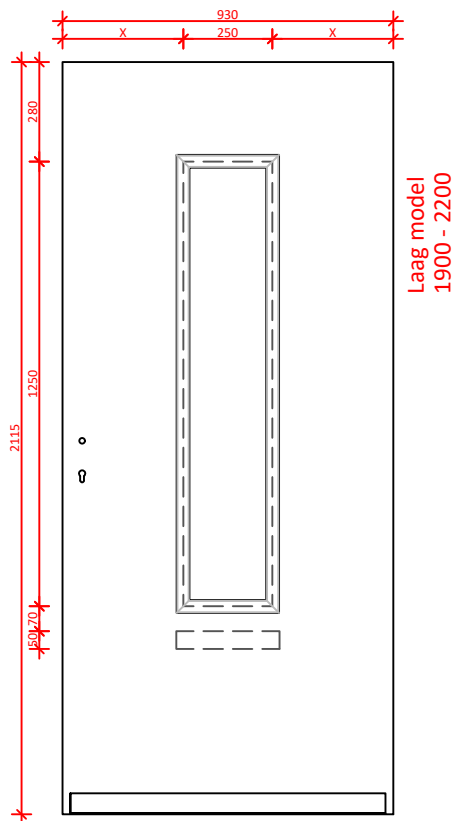

DATUM:	GEWIJZIGD:	CALCULATIENR:	TEKENINGNR: 9155N	MODEL:	HOUTSOORT:
			KLANT/PROJECT: overzicht modellen 9155N		DCM NUMMER:
			AANVRAAG:	SCHAAL:	GETEKEND: MN

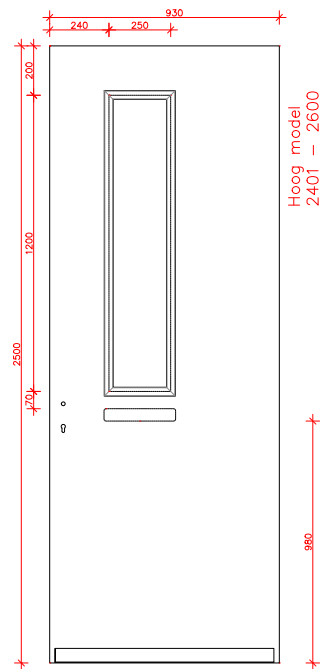
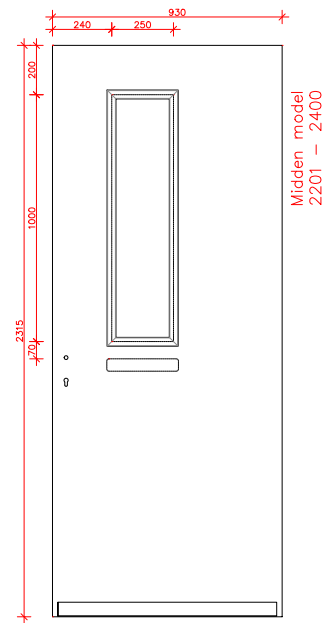
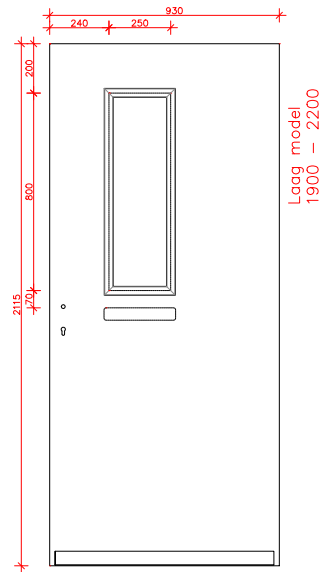

DATUM:	GEWIJZIGD:	CALCULATIENR:	TEKENINGNR: 9156N	MODEL: 9156N	HOUTSOORT:
			KLANT/PROJECT: overzicht modellen 9156N		DCM NUMMER:
			AANVRAAG:	SCHAAL:	GETEKEND: MN

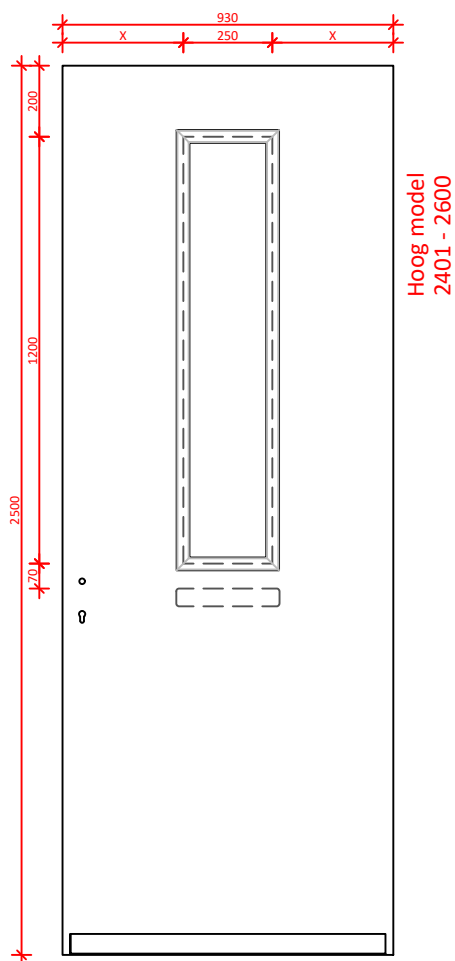
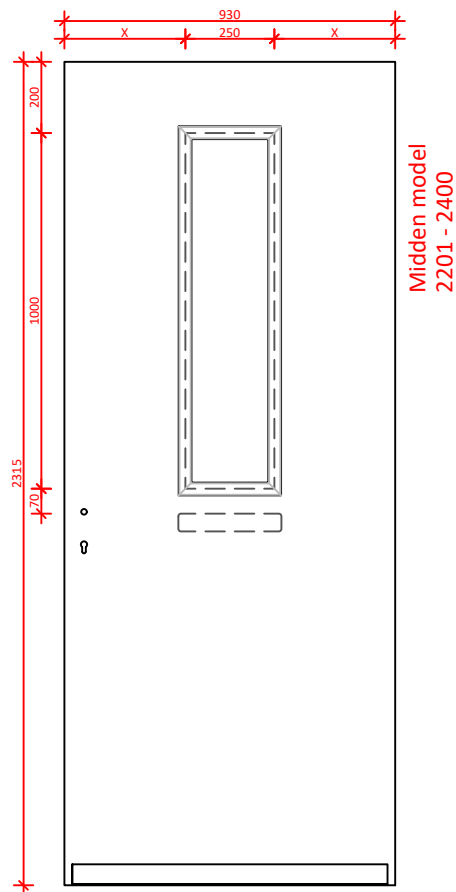
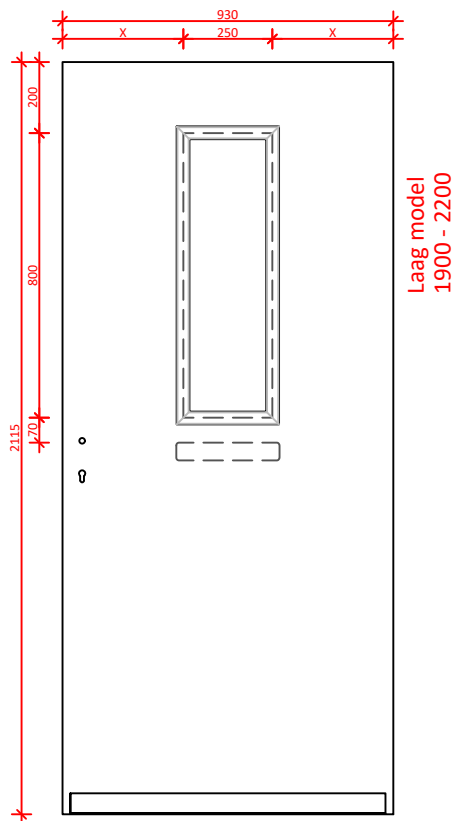

DATUM:	GEWIJZIGD:	CALCULATIENR:	TEKENINGNR: 9157N	MODEL:	HOUTSOORT:
--------	------------	---------------	----------------------	--------	------------

<b>KEGRO   DEUREN</b>	KLANT/PROJECT: overzicht modellen 9157N			DCM NUMMER:
-----------------------	--	--	--	-------------

AANVRAAG:	SCHAAL:	GETEKEND: MN	LEVERWEEK:	1.2a P.8
-----------	---------	-----------------	------------	----------

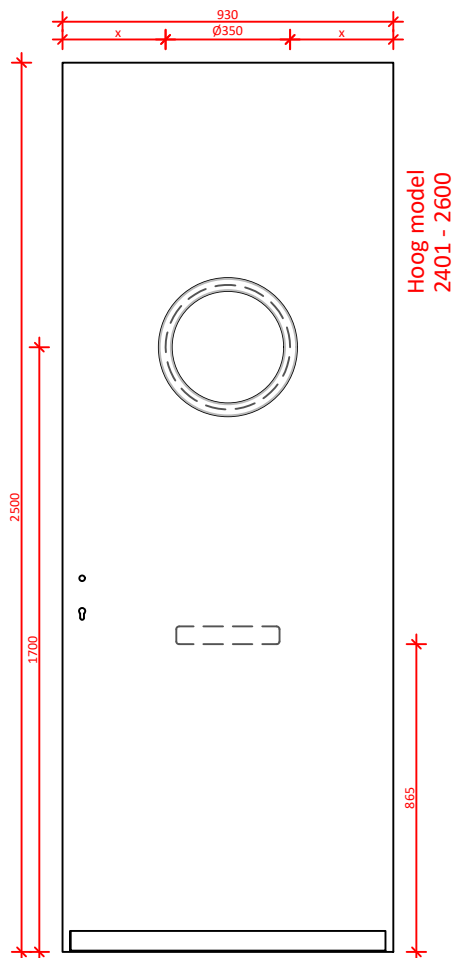
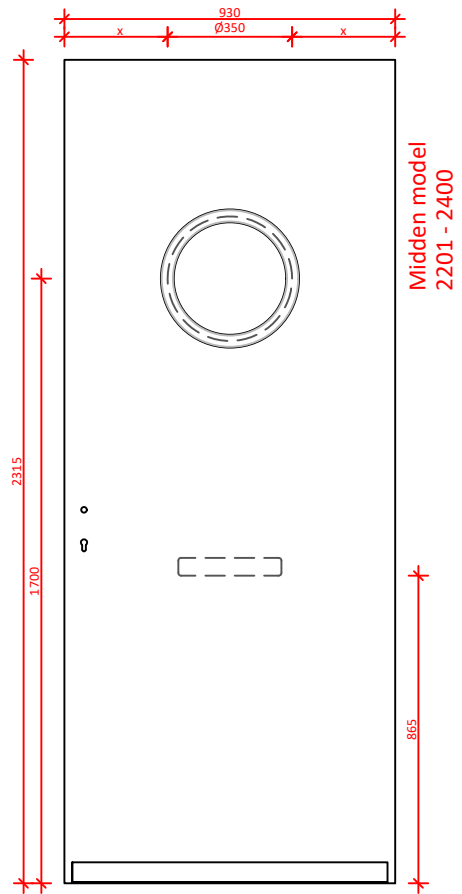
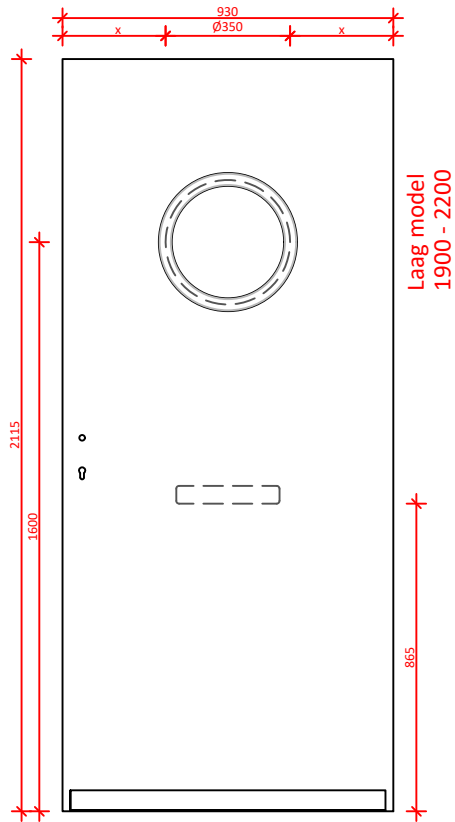

DATUM:	GEWIJZIGD:	CALCULATIENR:	TEKENINGNR: 9162N	MODEL:	HOUTSOORT:
--------	------------	---------------	----------------------	--------	------------

<b>KEGRO   DEUREN</b>	KLANT/PROJECT: overzicht modellen 9162N			DCM NUMMER:
-----------------------	--	--	--	-------------

AANVRAAG:	SCHAAL:	GETEKEND:	LEVERWEEK:	1.2a P.9
-----------	---------	-----------	------------	----------

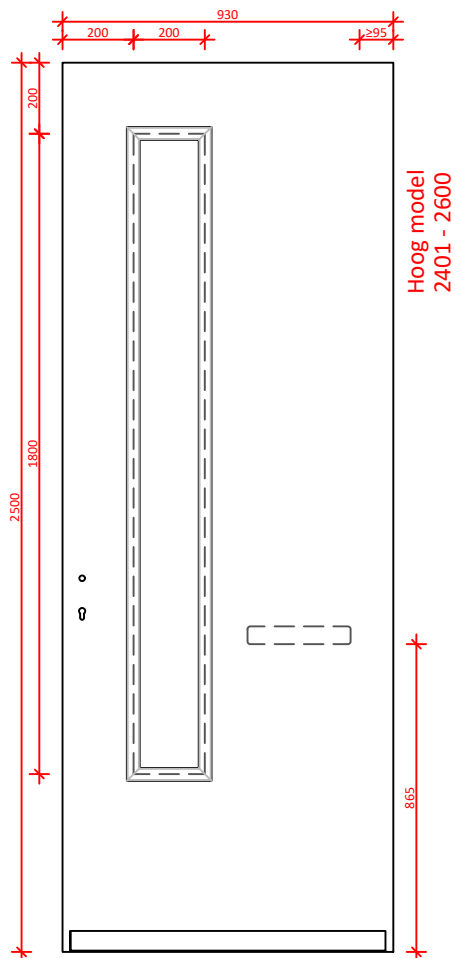
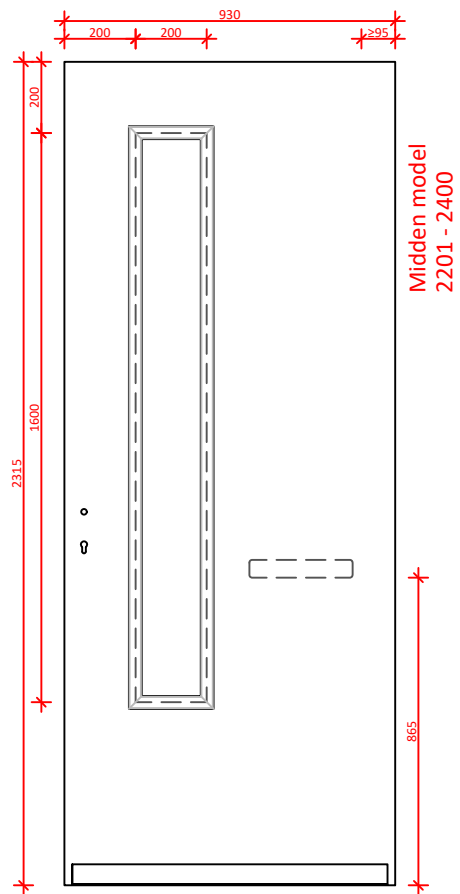
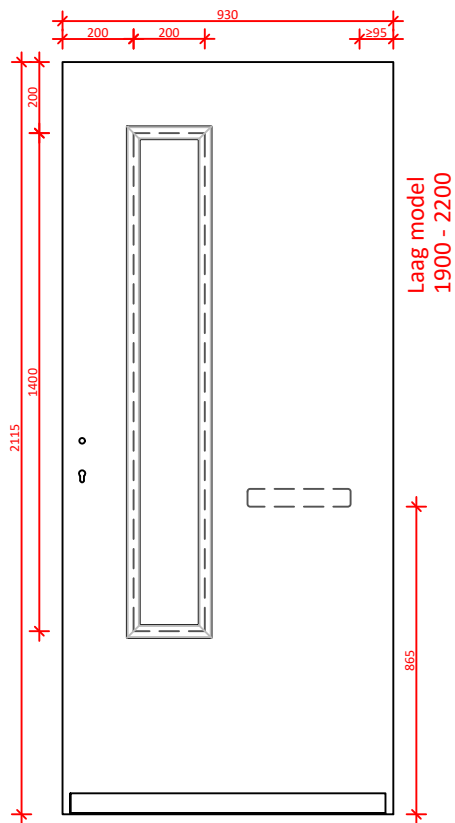

DATUM:	GEWIJZIGD:	CALCULATIENR:	TEKENINGNR: 9163N	MODEL:	HOUTSOORT:
--------	------------	---------------	----------------------	--------	------------

	KLANT/PROJECT: overzicht modellen 9163N L1 - R4			DCM NUMMER:
--	--	--	--	-------------

AANVRAAG:	SCHAAL:	GETEKEND: MN	LEVERWEEK:	1.2a P.10
-----------	---------	-----------------	------------	-----------

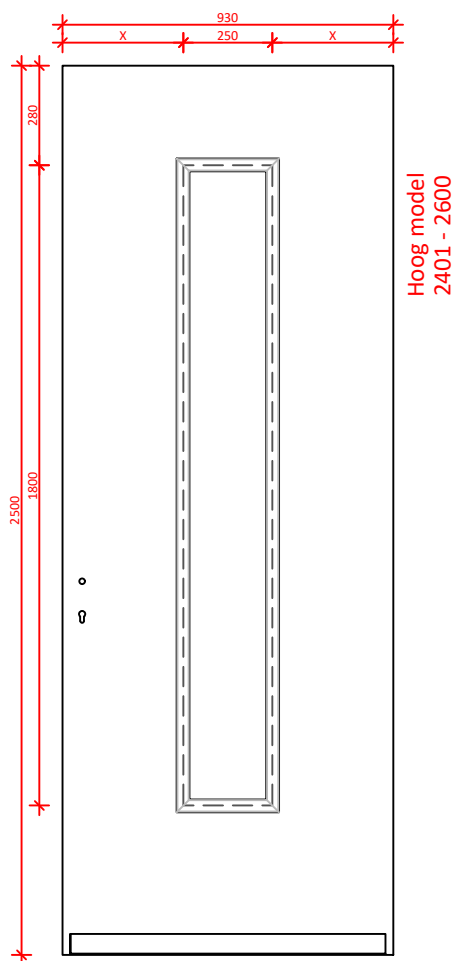
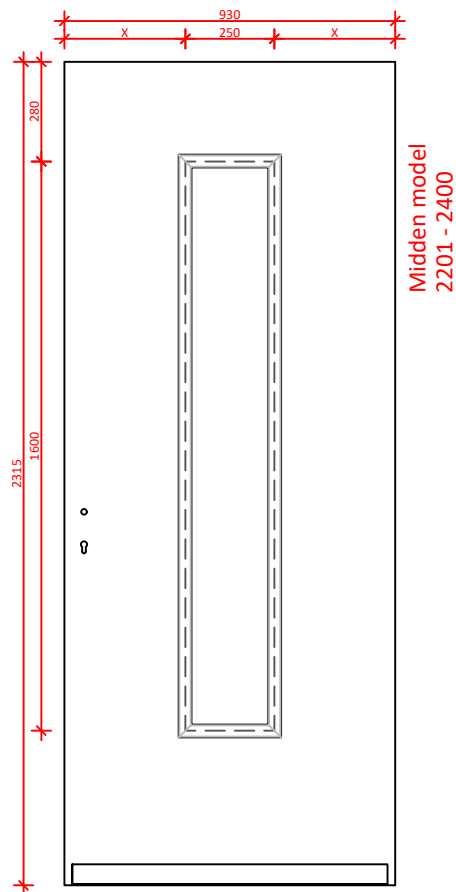
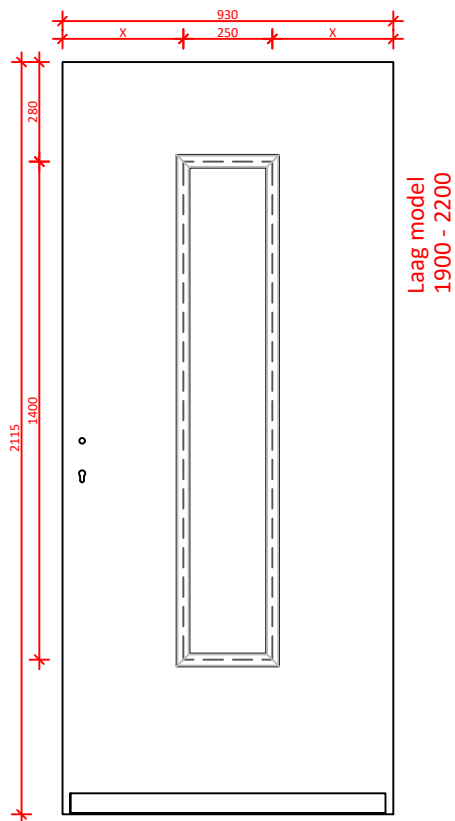

DATUM:	GEWIJZIGD:	CALCULATIENR:	TEKENINGNR: 9165N	MODEL:	HOUTSOORT:
--------	------------	---------------	----------------------	--------	------------

	KLANT/PROJECT: overzicht modellen 9165N			DCM NUMMER:
--	--	--	--	-------------

AANVRAAG:	SCHAAL:	GETEKEND: MN	LEVERWEEK:	1.2a P.11
-----------	---------	-----------------	------------	-----------

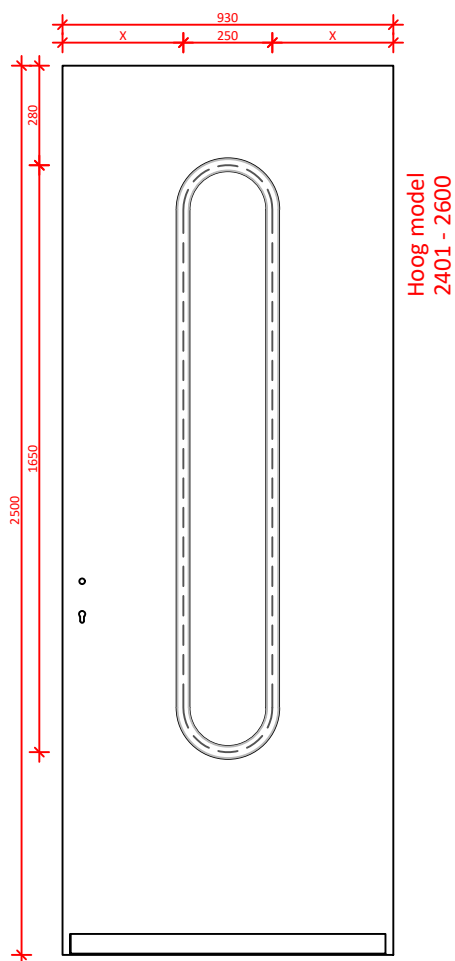
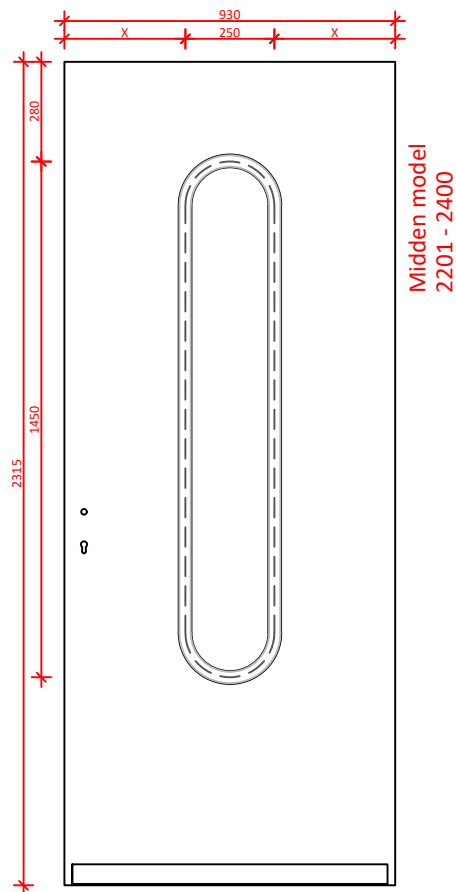
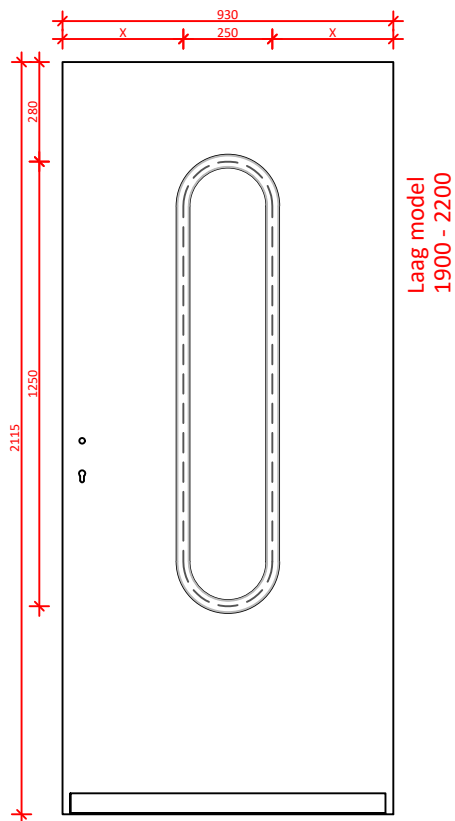

DATUM:	GEWIJZIGD:	CALCULATIENR:	TEKENINGNR: 9166N	MODEL:	HOUTSOORT:
--------	------------	---------------	----------------------	--------	------------

	KLANT/PROJECT: overzicht modellen 9166N			DCM NUMMER:
--	--	--	--	-------------

AANVRAAG:	SCHAAL:	GETEKEND: MN	LEVERWEEK:	1.2a P.12
-----------	---------	-----------------	------------	-----------



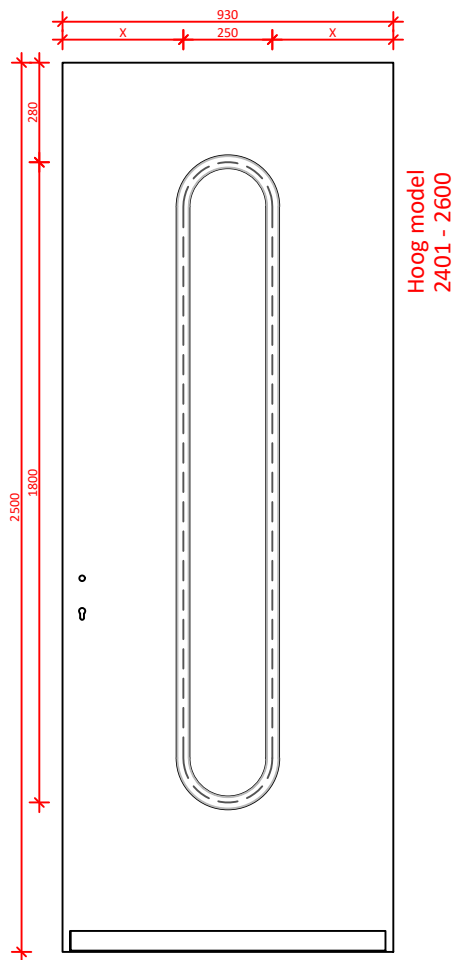
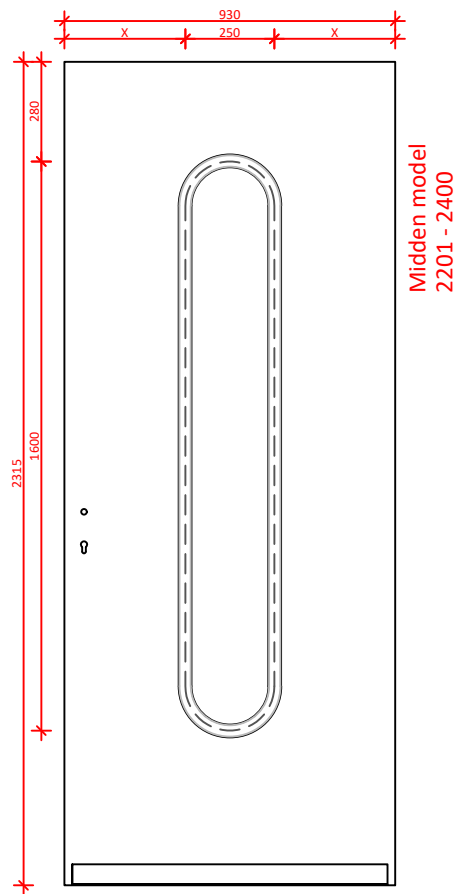
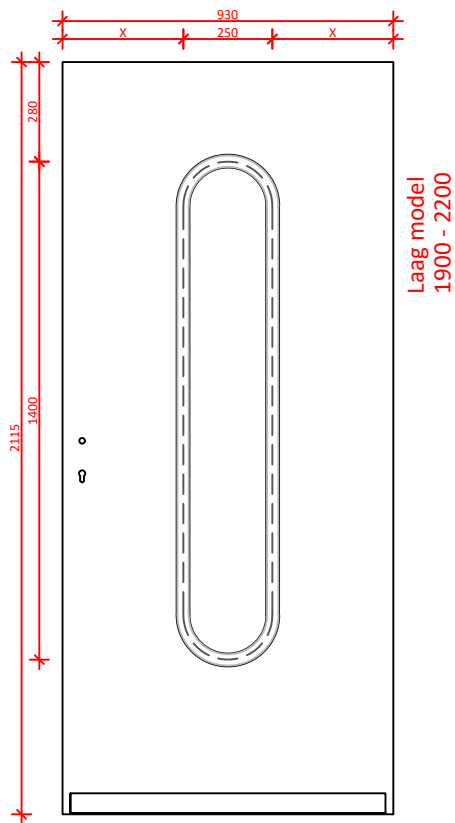

DATUM:	GEWIJZIGD:	CALCULATIENR:	TEKENINGNR: 9167N	MODEL:	HOUTSOORT:
--------	------------	---------------	----------------------	--------	------------

	KLANT/PROJECT: overzicht modellen 9167N			DCM NUMMER:
--	--	--	--	-------------

AANVRAAG:	SCHAAL:	GETEKEND: MN	LEVERWEEK:	1.2a P.13
-----------	---------	-----------------	------------	-----------

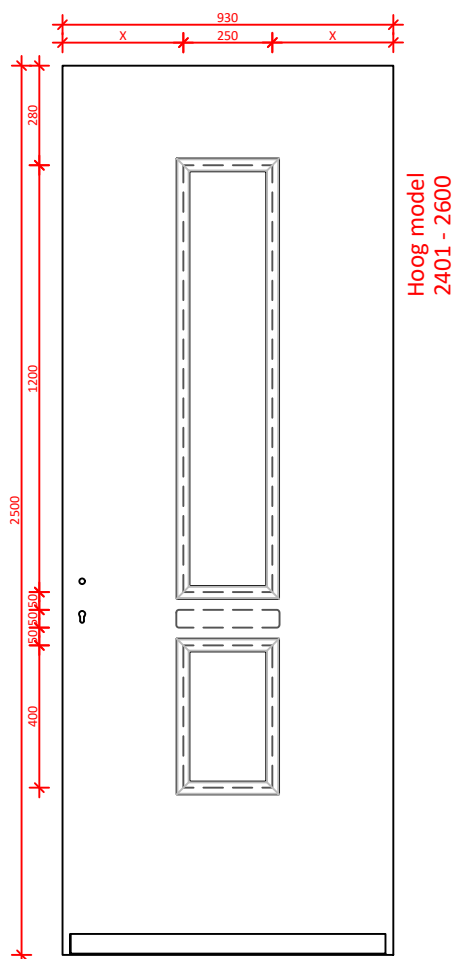
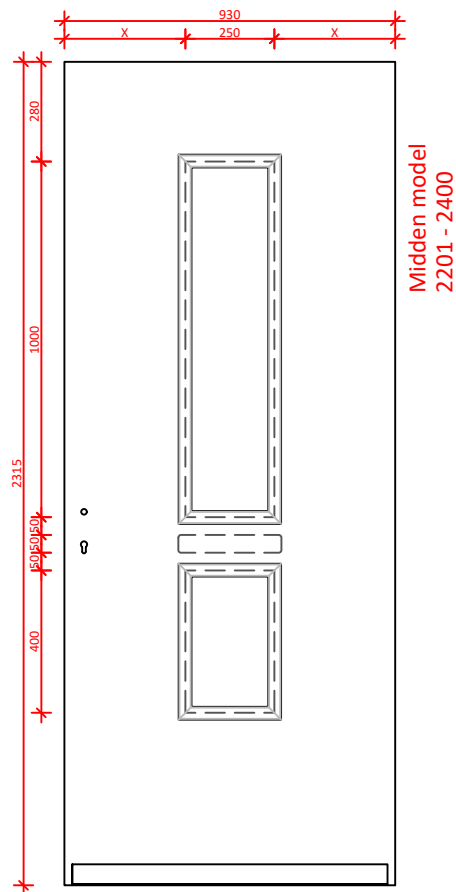
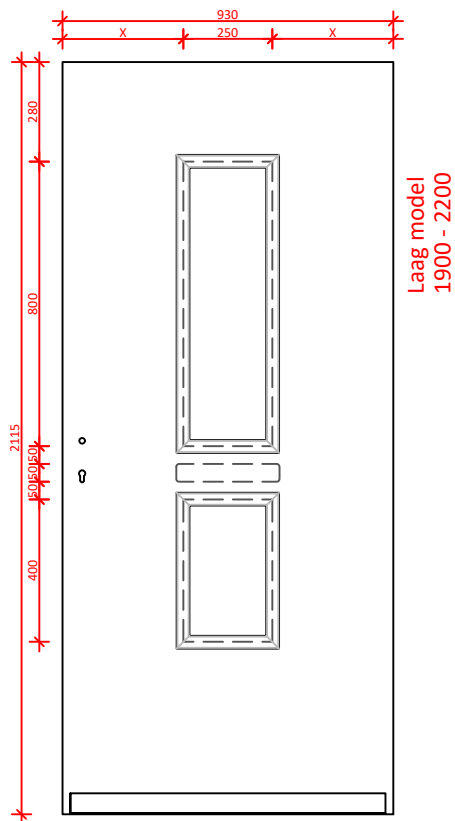

DATUM:	GEWIJZIGD:	CALCULATIENR:	TEKENINGNR: 9168N	MODEL:	HOUTSOORT:
--------	------------	---------------	----------------------	--------	------------

	KLANT/PROJECT: overzicht modellen 9168N			DCM NUMMER:
--	--	--	--	-------------

AANVRAAG:	SCHAAL:	GETEKEND: MN	LEVERWEEK:	1.2a P.14
-----------	---------	-----------------	------------	-----------

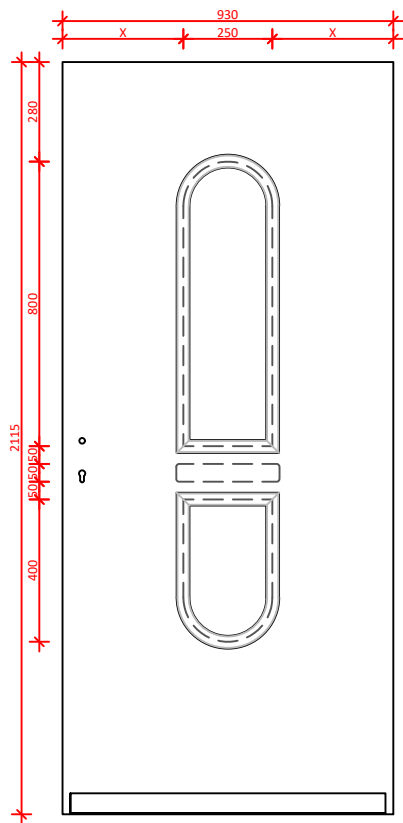

Laag model  
1900 - 2200

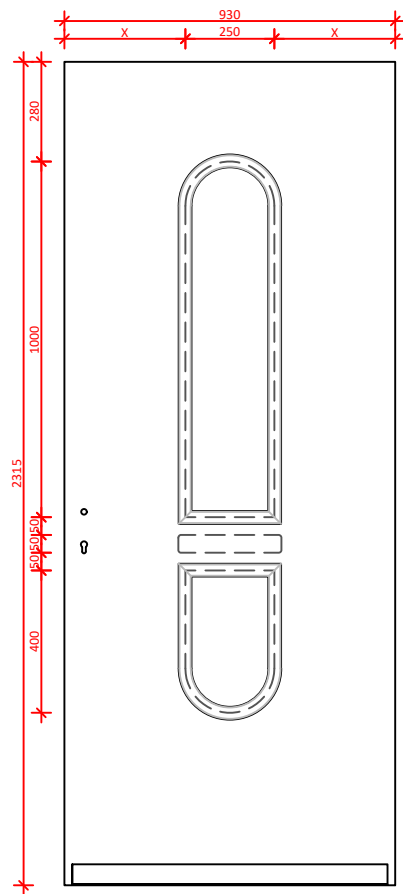

Midden model  
2201 - 2400

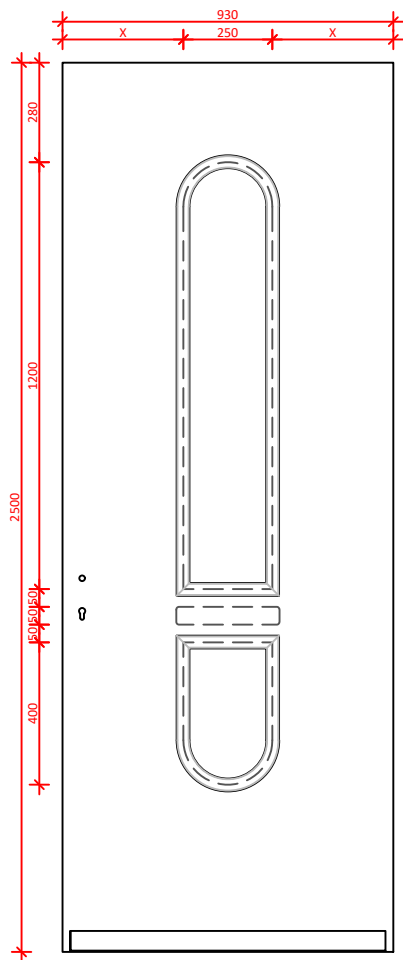

Hoog model  
2401 - 2600

DATUM:	GEWIJZIGD:	CALCULATIENR:	TEKENINGNR: 9169N	MODEL:	HOUTSOORT:
--------	------------	---------------	----------------------	--------	------------

	KLANT/PROJECT: overzicht modellen 9169N			DCM NUMMER:
--	--	--	--	-------------

AANVRAAG:	SCHAAL:	GETEKEND: MN	LEVERWEEK:	1.2a P.15
-----------	---------	-----------------	------------	-----------

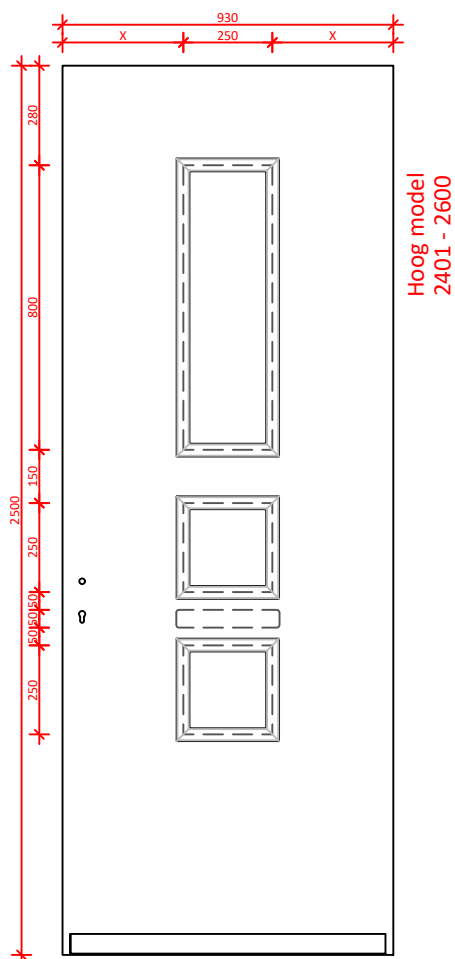
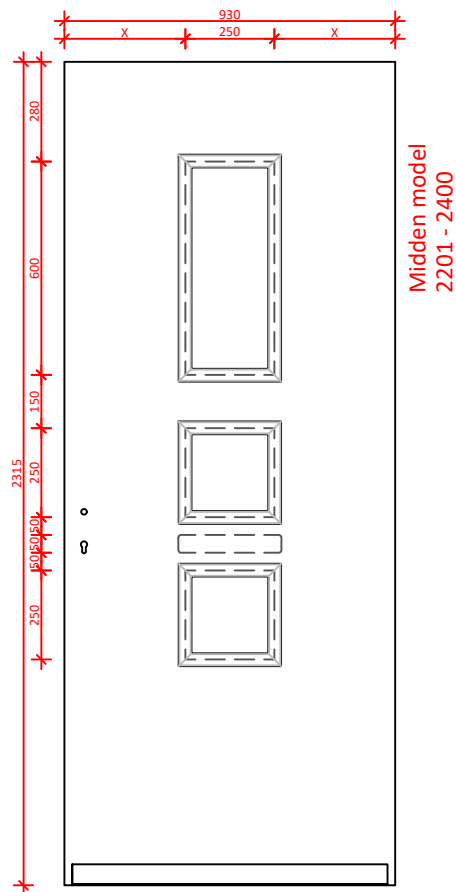
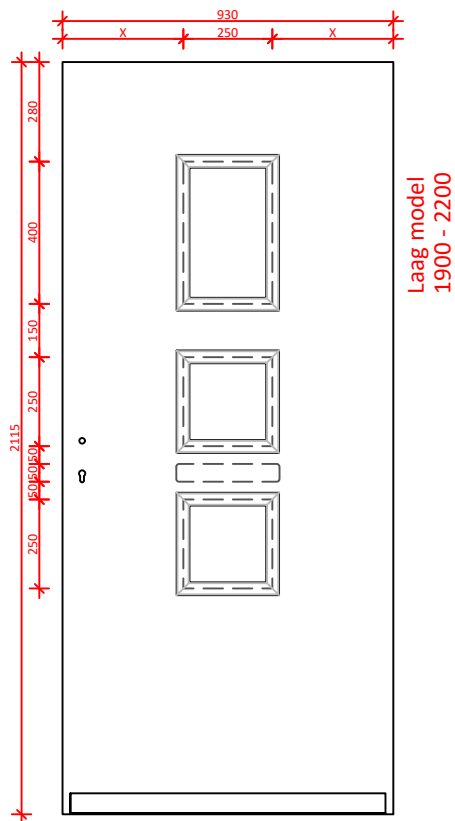

DATUM:	GEWIJZIGD:	CALCULATIENR:	TEKENINGNR:	MODEL: 9170N	HOUTSOORT:
--------	------------	---------------	-------------	-----------------	------------

	KLANT/PROJECT: overzicht modellen 9170N			DCM NUMMER:
--	--	--	--	-------------

AANVRAAG:	SCHAAL:	GETEKEND: MN	LEVERWEEK: 1.2a P.16
-----------	---------	-----------------	-------------------------

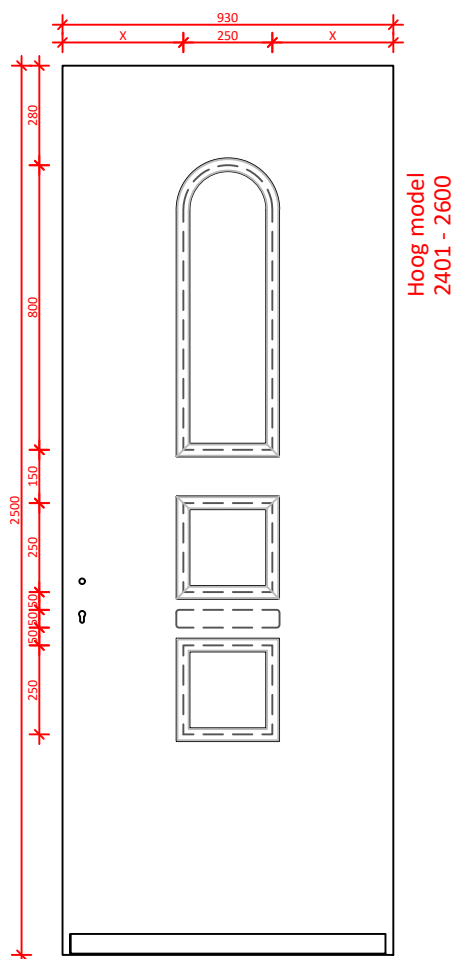
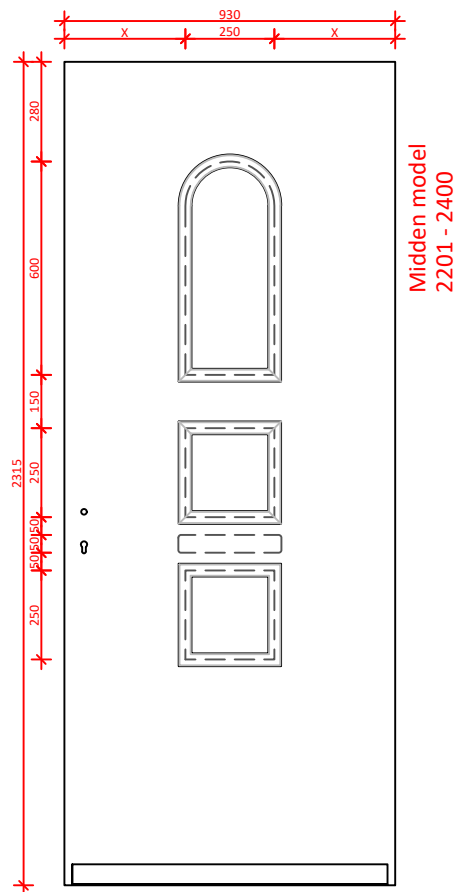
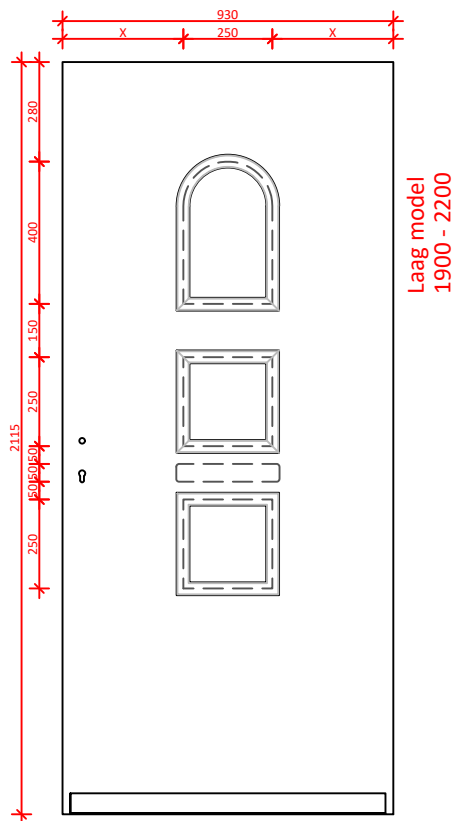

DATUM:	GEWIJZIGD:	CALCULATIENR:	TEKENINGNR:	MODEL: 9171N	HOUTSOORT:
--------	------------	---------------	-------------	-----------------	------------

<b>KEGRO   DEUREN</b>	KLANT/PROJECT: overzicht modellen 9171N			DCM NUMMER:
-----------------------	--	--	--	-------------

AANVRAAG:	SCHAAL:	GETEKEND: MN	LEVERWEEK: 1.2a P.17
-----------	---------	-----------------	-------------------------

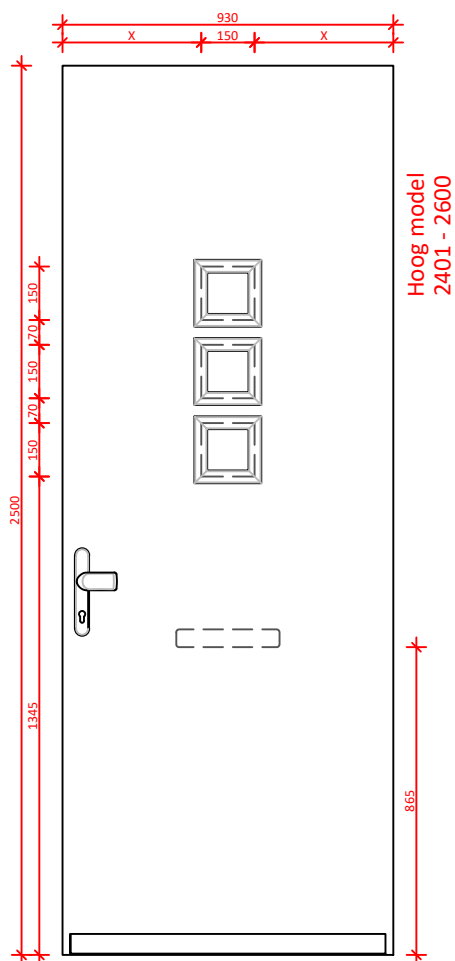
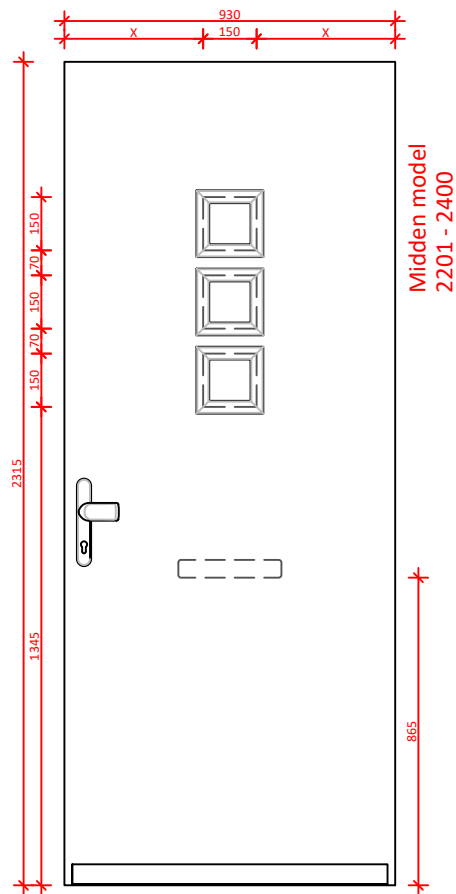
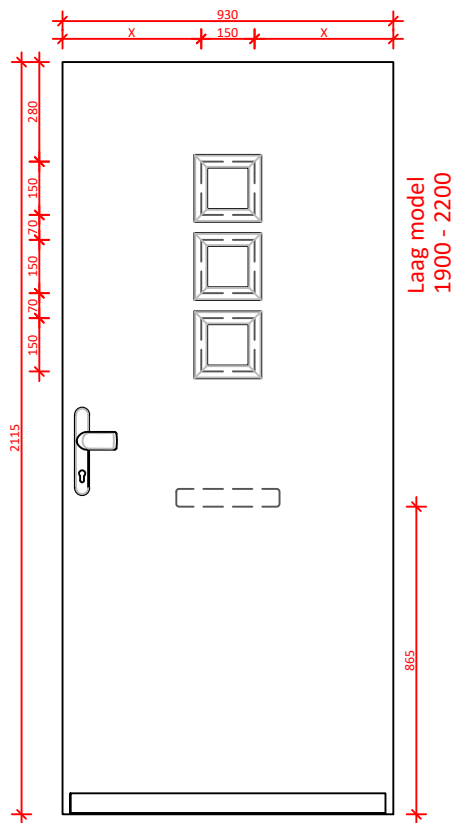

DATUM:	GEWIJZIGD:	CALCULATIENR:	TEKENINGNR:	MODEL: 9172N	HOUTSOORT:
--------	------------	---------------	-------------	-----------------	------------

<b>KEGRO   DEUREN</b>	KLANT/PROJECT: overzicht modellen 9172N			DCM NUMMER:
-----------------------	--	--	--	-------------

AANVRAAG:	SCHAAL:	GETEKEND: MN	LEVERWEEK: 1.2a P.18
-----------	---------	-----------------	-------------------------

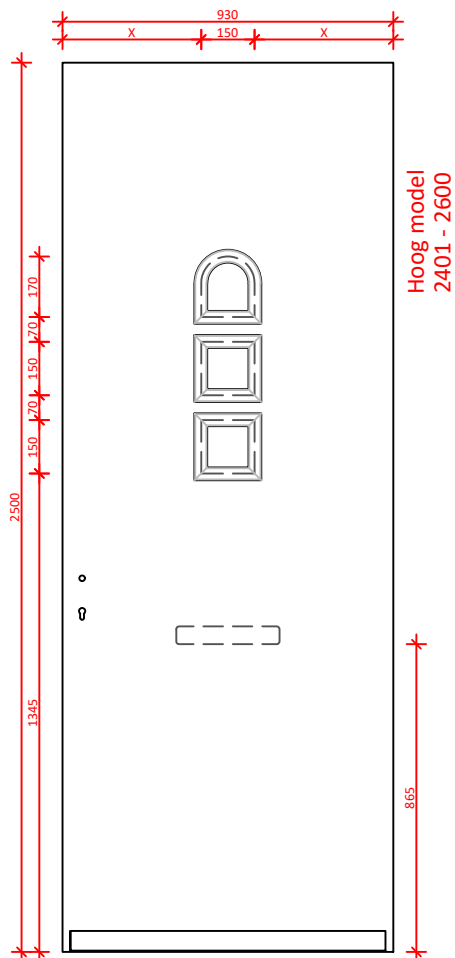
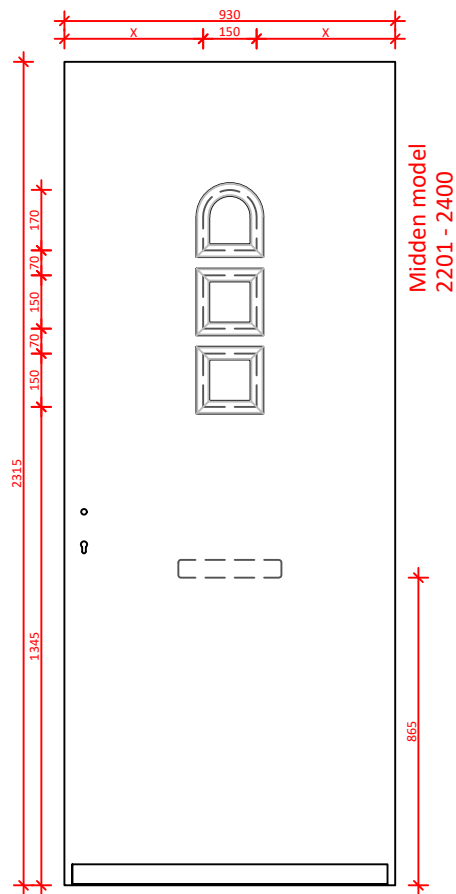
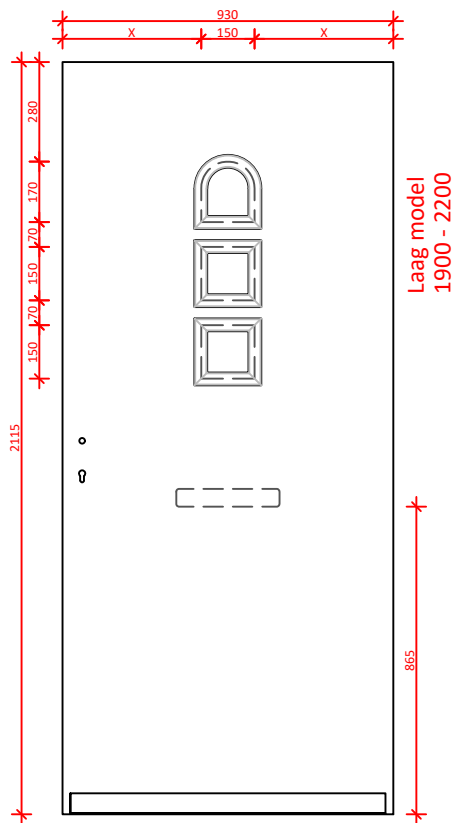

DATUM:	GEWIJZIGD:	CALCULATIENR:	TEKENINGNR:	MODEL: 9173N	HOUTSOORT:
			KLANT/PROJECT: overzicht modellen 9173N		DCM NUMMER:
			AANVRAAG:	SCHAAL:	GETEKEND: MN

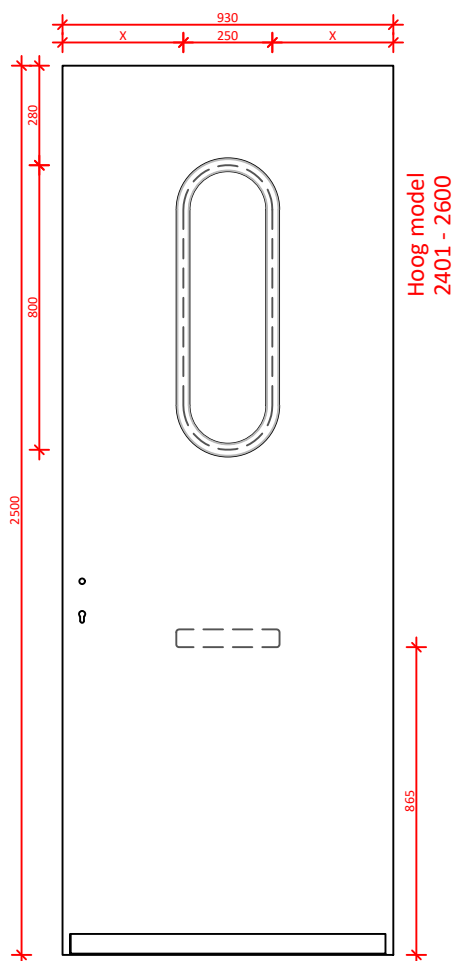
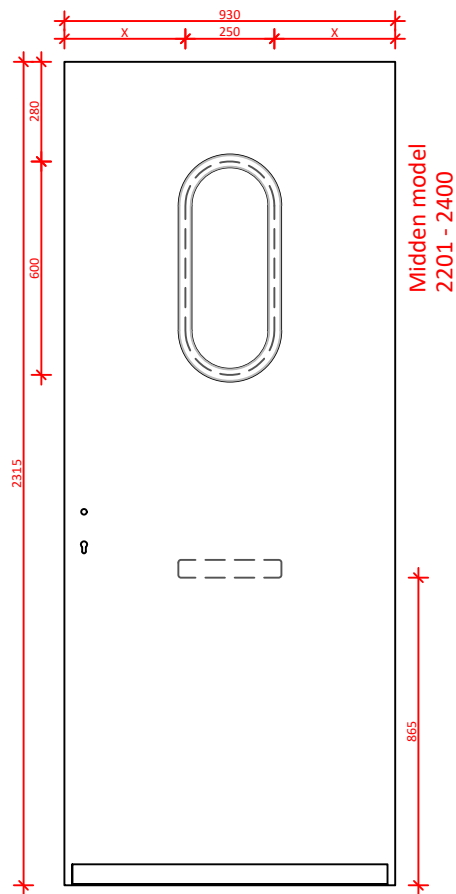
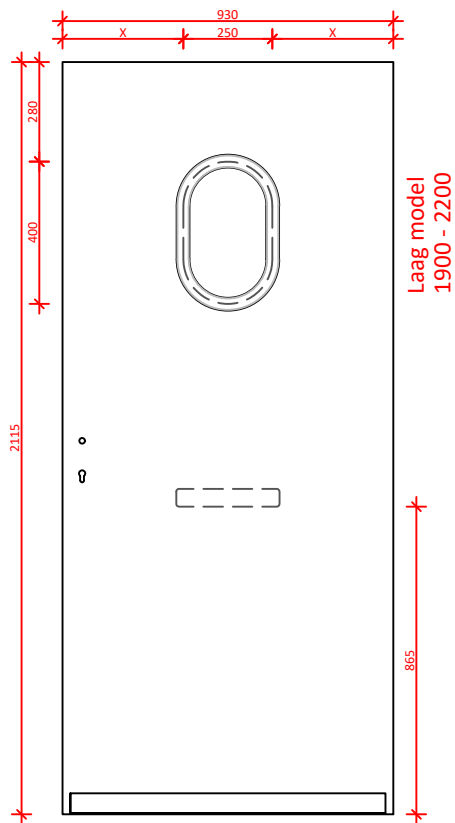

DATUM:	GEWIJZIGD:	CALCULATIENR:	TEKENINGNR:	MODEL: 9174N	HOUTSOORT:
--------	------------	---------------	-------------	-----------------	------------

	KLANT/PROJECT: overzicht modellen 9174N			DCM NUMMER:
--	--	--	--	-------------

AANVRAAG:	SCHAAL:	GETEKEND: MN	LEVERWEEK:	1.2a P.20
-----------	---------	-----------------	------------	-----------



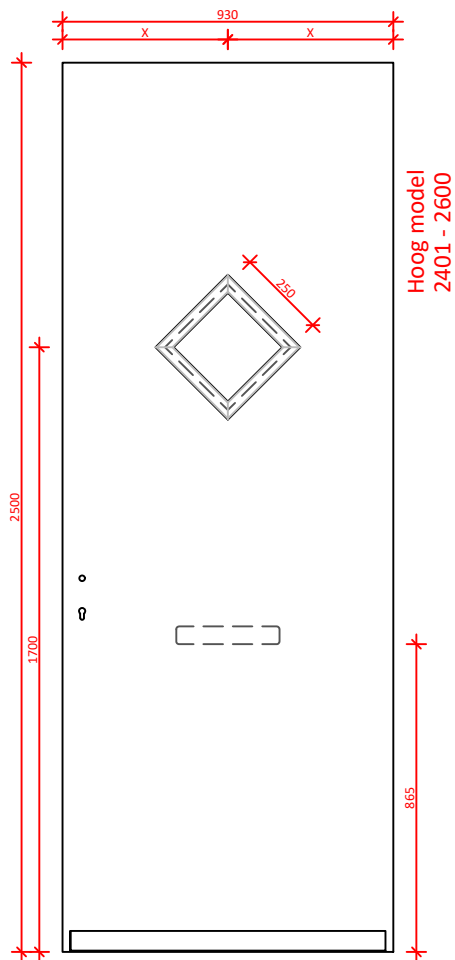
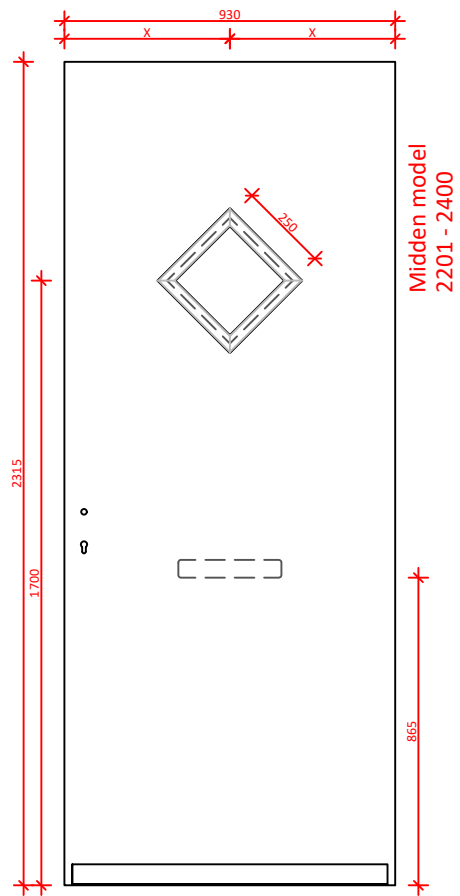
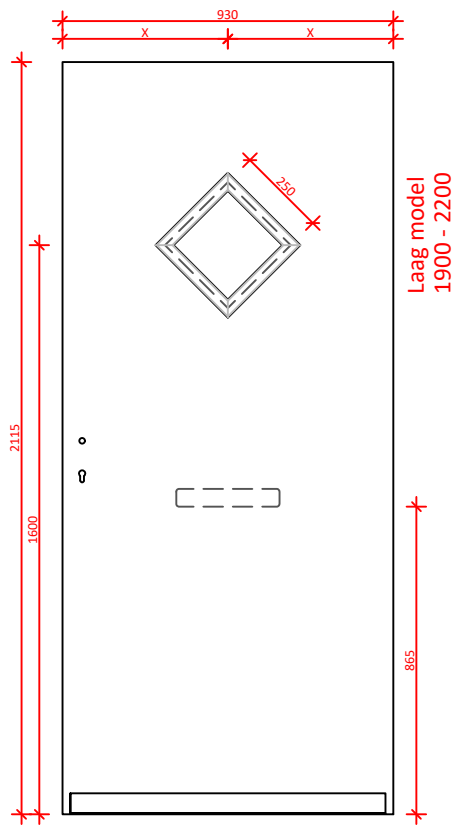

DATUM:	GEWIJZIGD:	CALCULATIENR:	TEKENINGNR:	MODEL: 9175N	HOUTSOORT:
--------	------------	---------------	-------------	-----------------	------------

	KLANT/PROJECT: overzicht modellen 9175N			DCM NUMMER:
--	--	--	--	-------------

AANVRAAG:	SCHAAL:	GETEKEND: MN	LEVERWEEK:	1.2a P.21
-----------	---------	-----------------	------------	-----------

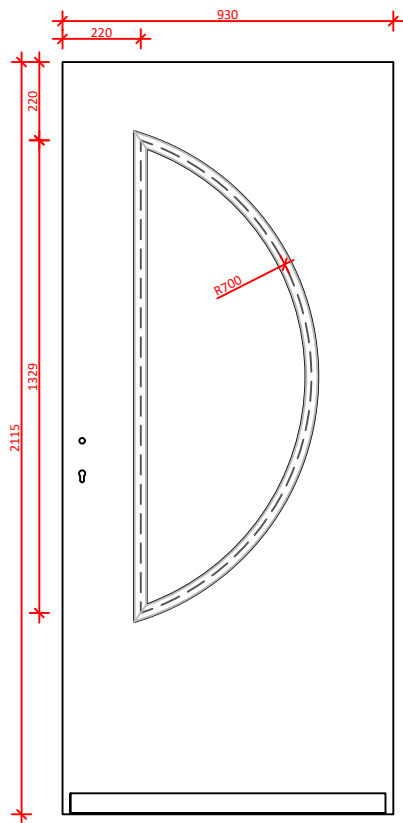

Laag model  
1900 - 2200

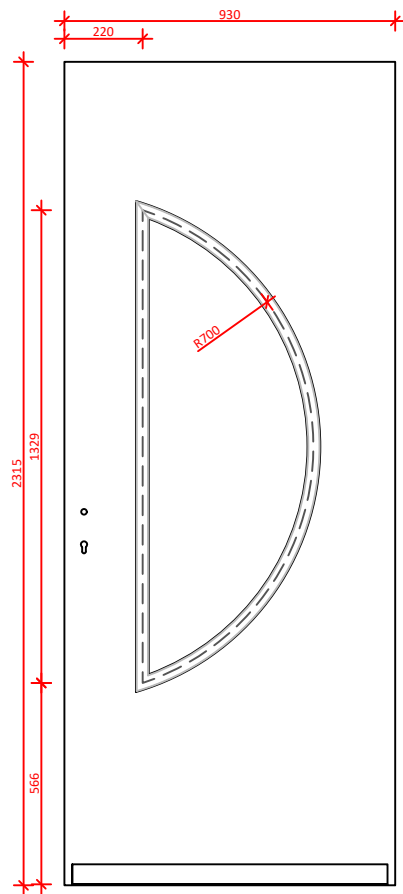

Midden model  
2201 - 2400

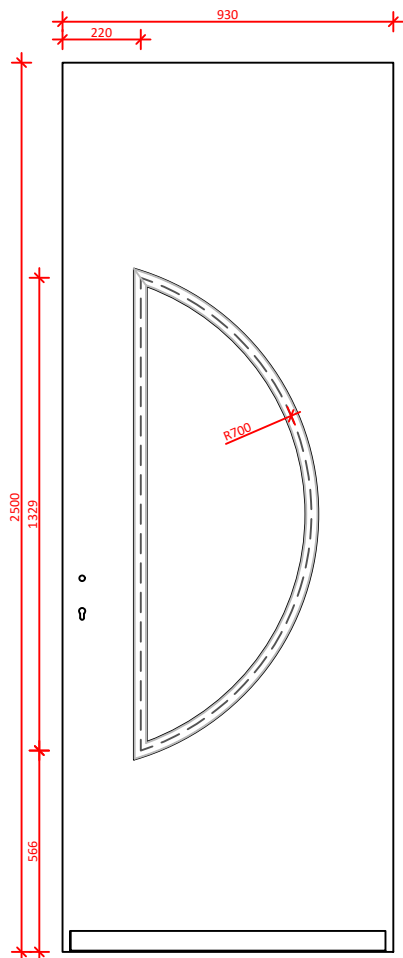

Hoog model  
2401 - 2600

DATUM:	GEWIJZIGD:	CALCULATIENR:	TEKENINGNR:	MODEL: 9176N	HOUTSOORT:
--------	------------	---------------	-------------	-----------------	------------

	KLANT/PROJECT: overzicht modellen 9176N L1 - R4			DCM NUMMER:
--	--	--	--	-------------

AANVRAAG:	SCHAAL:	GETEKEND: MN	LEVERWEEK:	1.2a P.22
-----------	---------	-----------------	------------	-----------

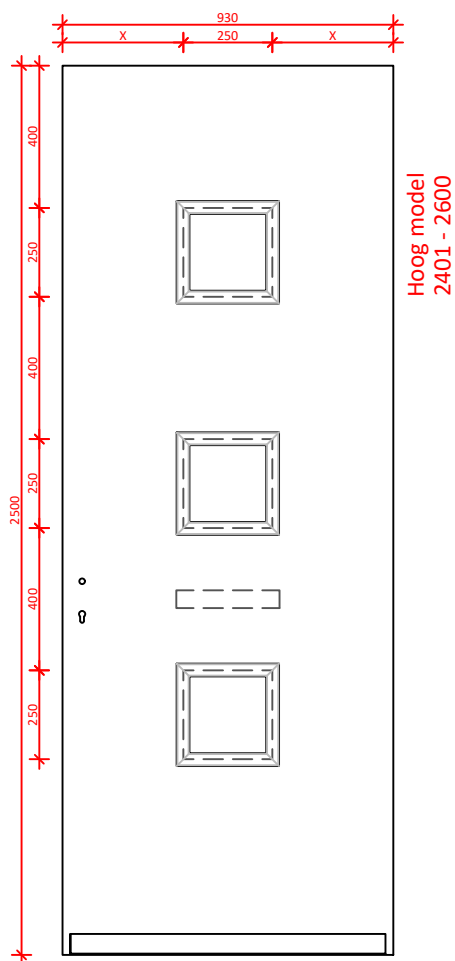
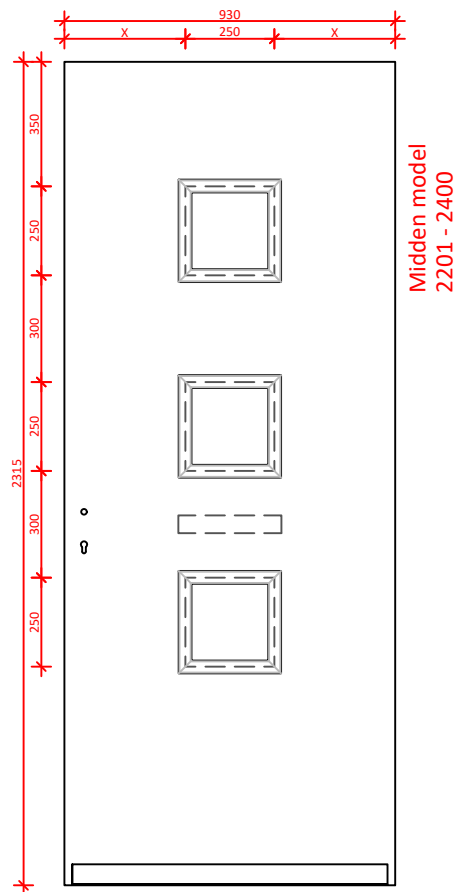
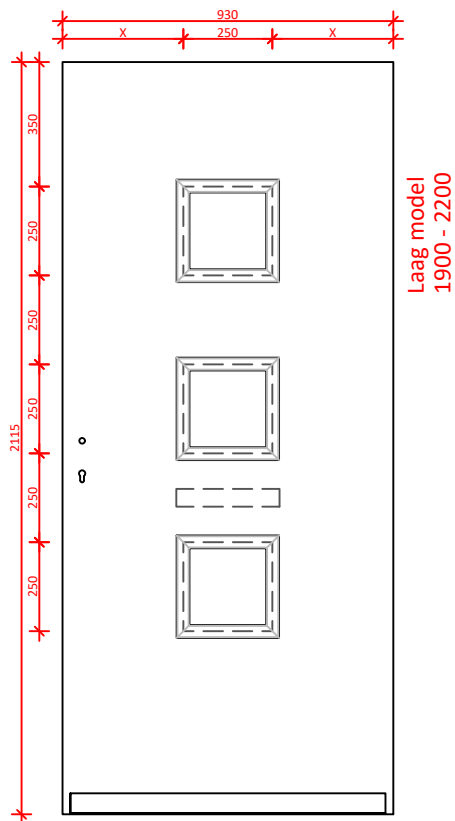

DATUM:	GEWIJZIGD:	CALCULATIENR:	TEKENINGNR:	MODEL: 9178N	HOUTSOORT:
--------	------------	---------------	-------------	-----------------	------------

<b>KEGRO   DEUREN</b>	KLANT/PROJECT: overzicht modellen 9178N			DCM NUMMER:
-----------------------	--	--	--	-------------

AANVRAAG:	SCHAAL:	GETEKEND: MN	LEVERWEEK:	1.2a P.23
-----------	---------	-----------------	------------	-----------

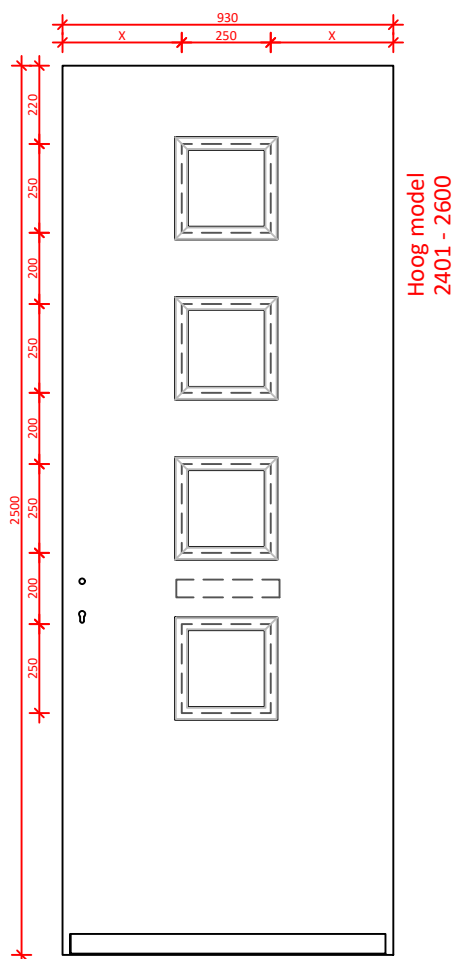
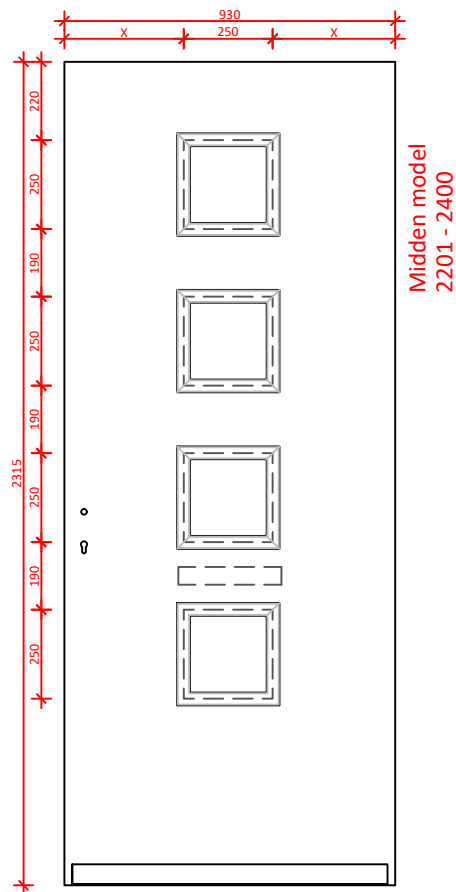
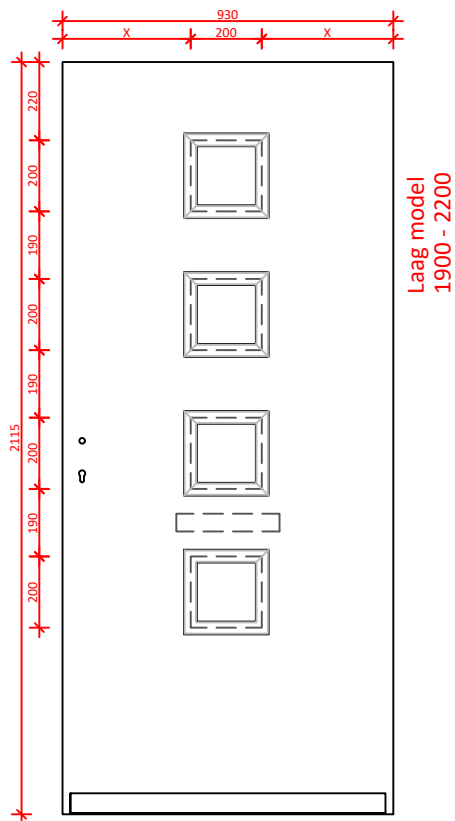

DATUM:	GEWIJZIGD:	CALCULATIENR:	TEKENINGNR:	MODEL: 9179N	HOUTSOORT:
--------	------------	---------------	-------------	-----------------	------------

	KLANT/PROJECT: overzicht modellen 9179N			DCM NUMMER:
--	--	--	--	-------------

AANVRAAG:	SCHAAL:	GETEKEND: MN	LEVERWEEK: 1.2a P.24
-----------	---------	-----------------	-------------------------

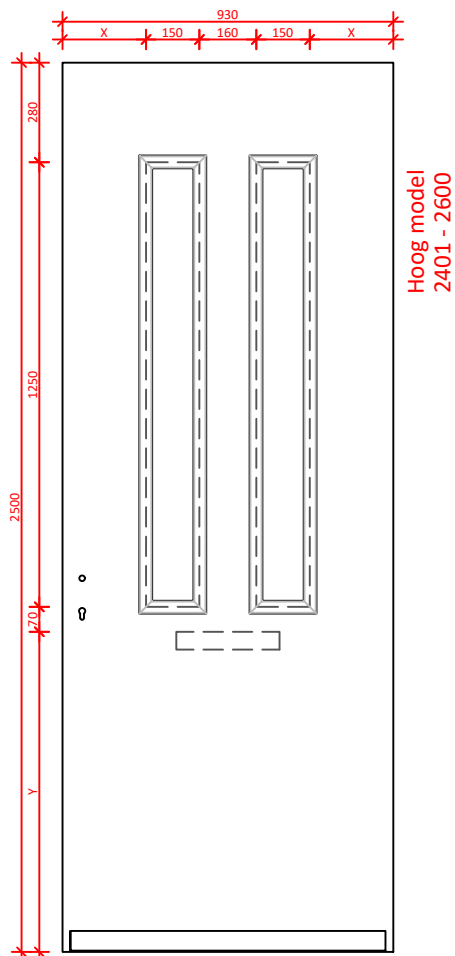
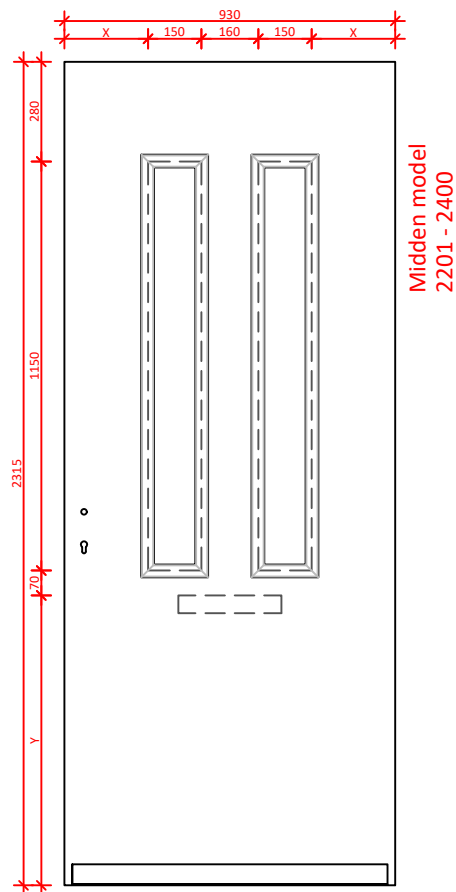
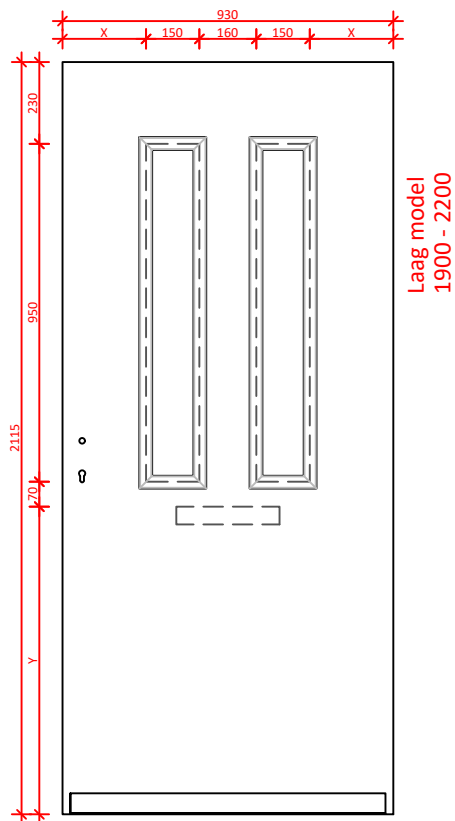

DATUM:	GEWIJZIGD:	CALCULATIENR:	TEKENINGNR:	MODEL: 9180N	HOUTSOORT:
			KLANT/PROJECT: overzicht modellen 9180N		DCM NUMMER:
			AANVRAAG:	SCHAAL:	GETEKEND: MN

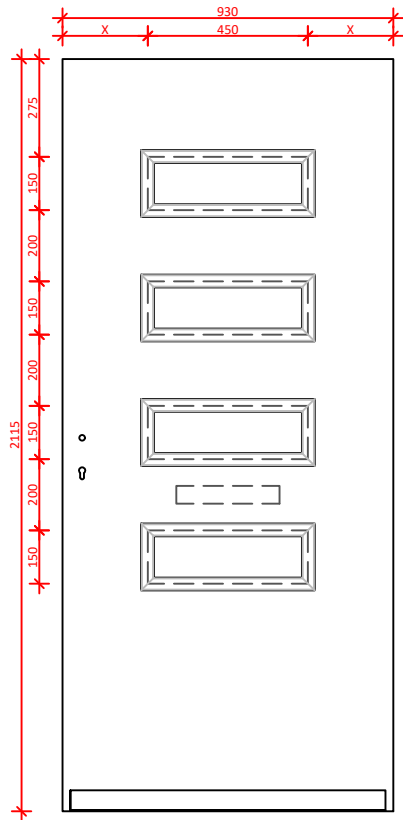

Laag model  
1900 - 2200

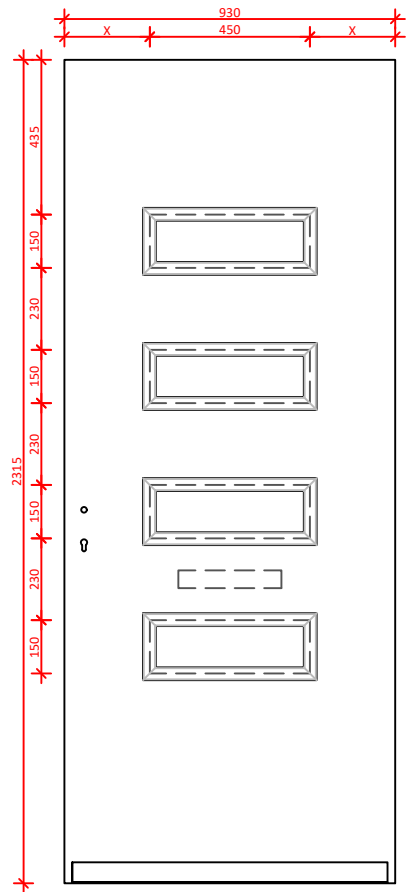

Midden model  
2201 - 2400

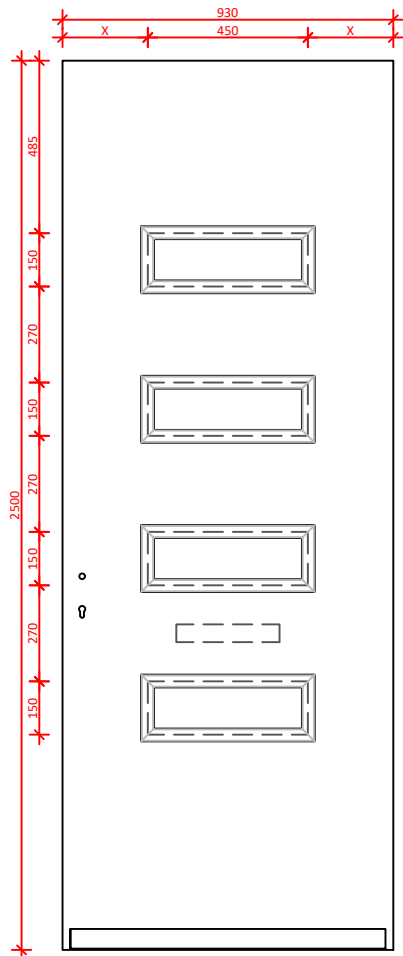

Hoog model  
2401 - 2600

Strakke SponningMaat van de glasopening:  
 Pasmaat deurbreedte t/m 1000 mm : SSM 450mm  
 Pasmaat deurbreedte 1001 t/m 1100 mm : SSM 550mm  
 Pasmaat deurbreedte > 1101 mm : SSM 650mm

DATUM:	GEWIJZIGD:	CALCULATIENR:	TEKENINGNR:	MODEL: 9181N	HOUTSOORT:
			KLANT/PROJECT: overzicht modellen 9181N		DCM NUMMER:
AANVRAAG:		SCHAAL:	GETEKEND: MN	LEVERWEEK: 1.2a P.26	

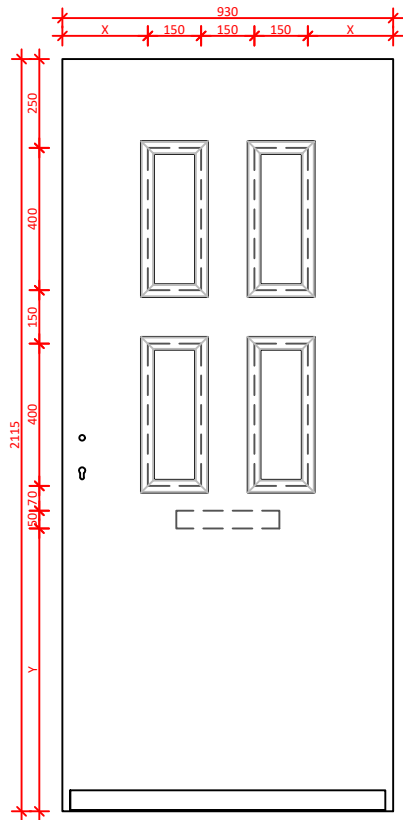

Laag model  
1900 - 2200

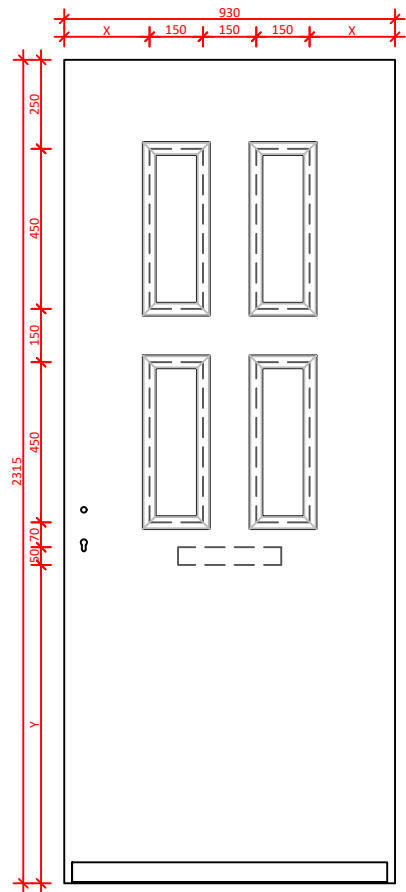

Midden model  
2201 - 2400

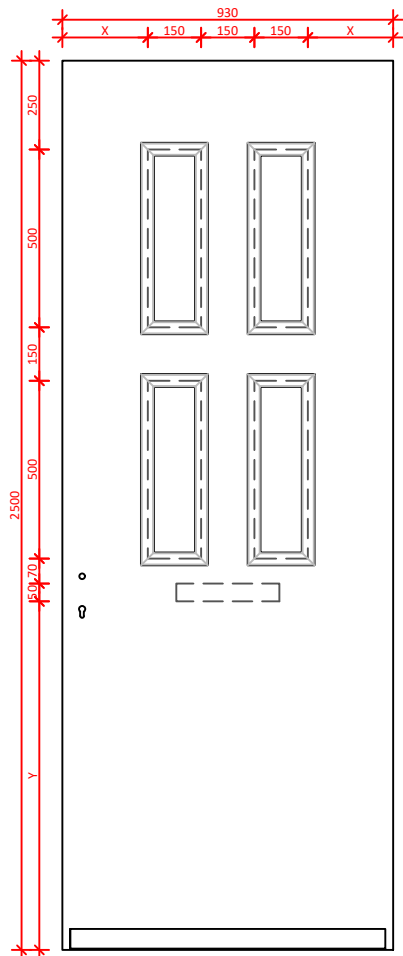

Hoog model  
2401 - 2600

DATUM:	GEWIJZIGD:	CALCULATIENR:	TEKENINGNR:	MODEL: 9182N	HOUTSOORT:
			KLANT/PROJECT: overzicht modellen 9182N		DCM NUMMER:
			AANVRAAG:	SCHAAL:	GETEKEND: MN

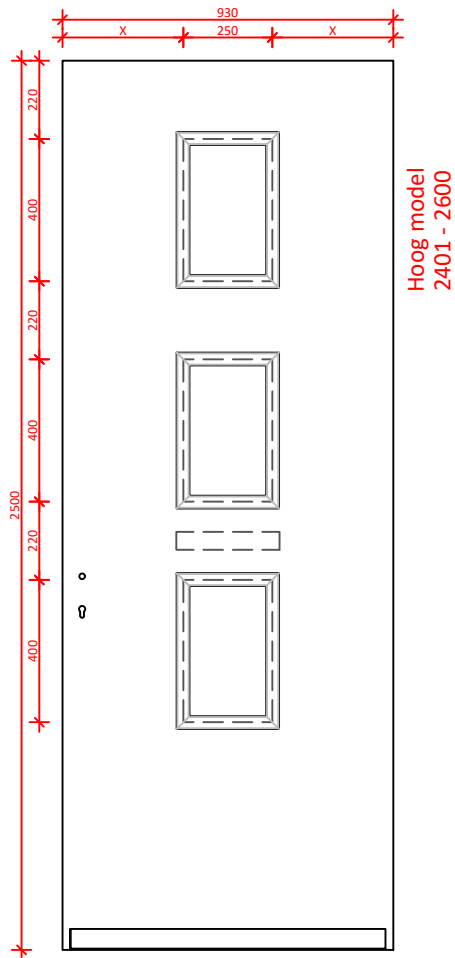
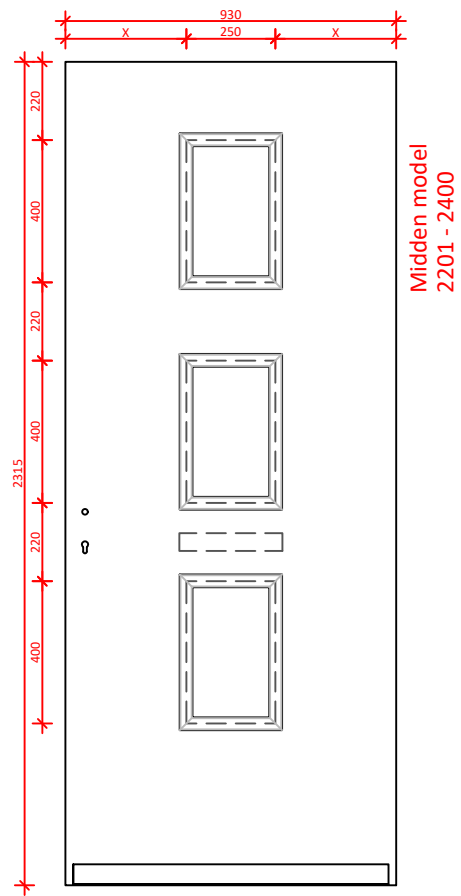
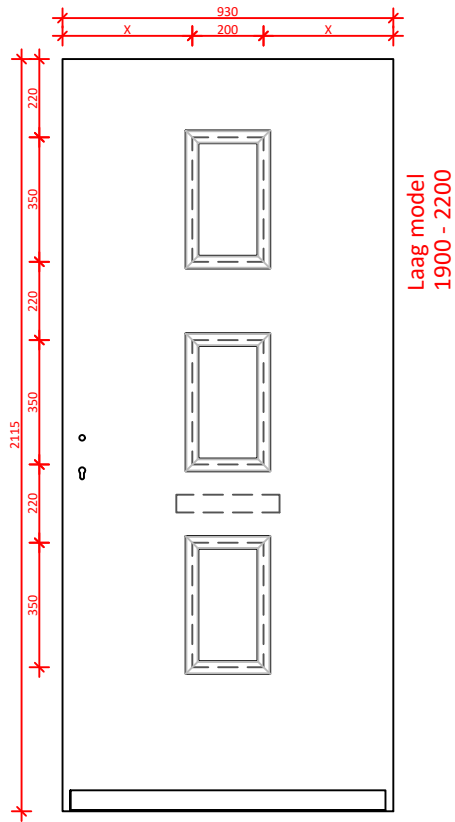

DATUM:	GEWIJZIGD:	CALCULATIENR:	TEKENINGNR:	MODEL: 9183N	HOUTSOORT:
--------	------------	---------------	-------------	-----------------	------------

<b>KEGRO   DEUREN</b>	KLANT/PROJECT: overzicht modellen 9183N			DCM NUMMER:
-----------------------	--	--	--	-------------

AANVRAAG:	SCHAAL:	GETEKEND: MN	LEVERWEEK: 1.2a P.28
-----------	---------	-----------------	-------------------------



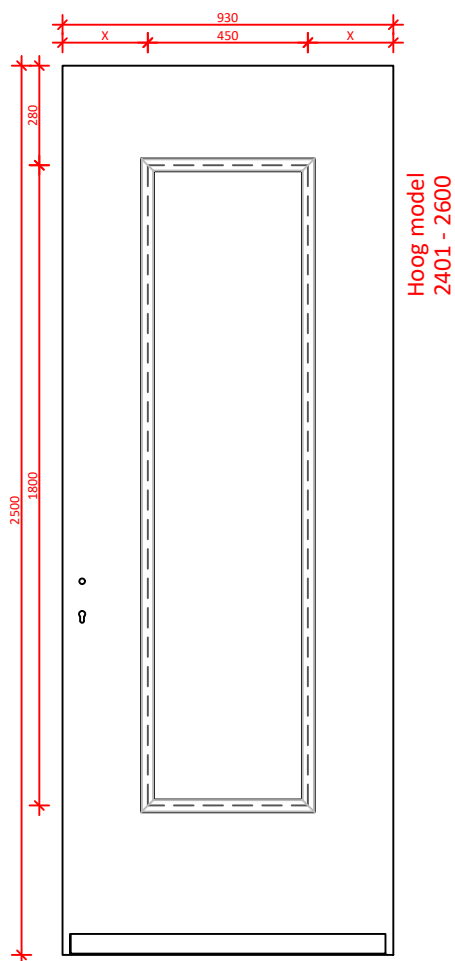
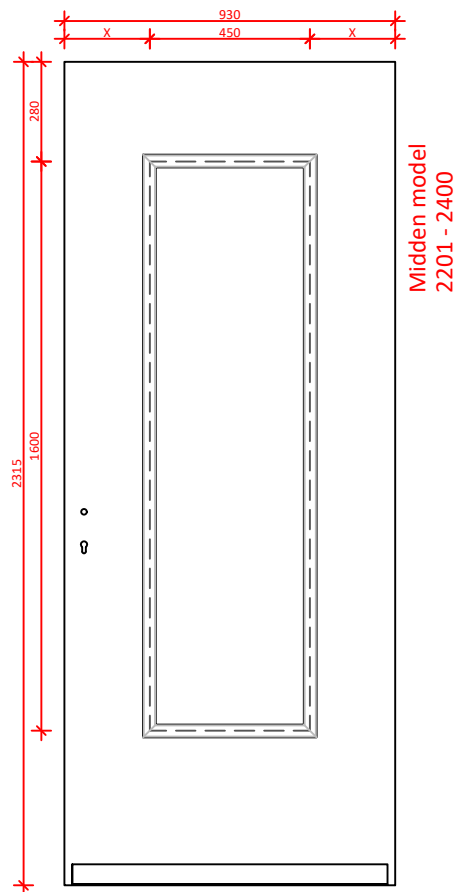
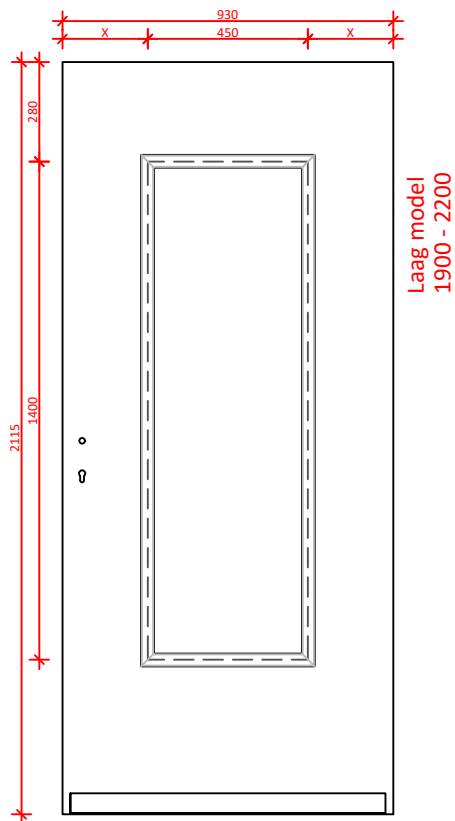



DATUM:	GEWIJZIGD:	CALCULATIENR:	TEKENINGNR:	MODEL: 9195N	HOUTSOORT:
--------	------------	---------------	-------------	-----------------	------------

	KLANT/PROJECT: overzicht modellen 9195N			DCM NUMMER:
--	--	--	--	-------------

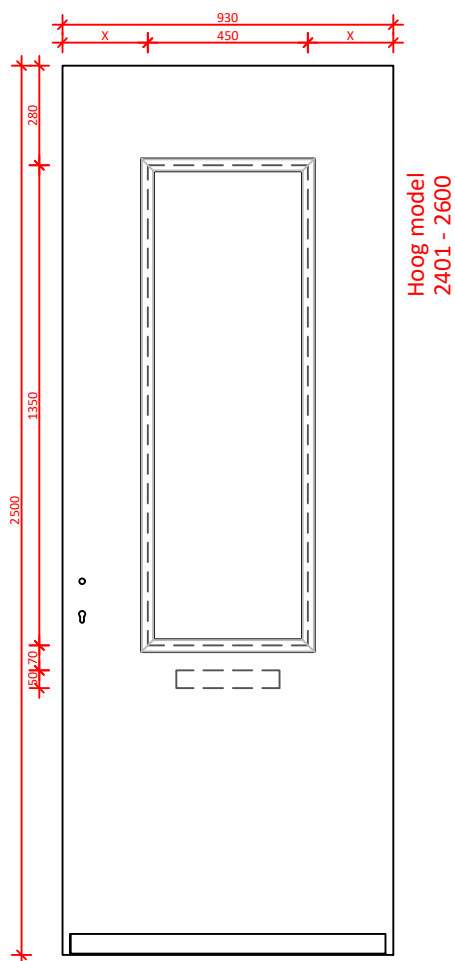
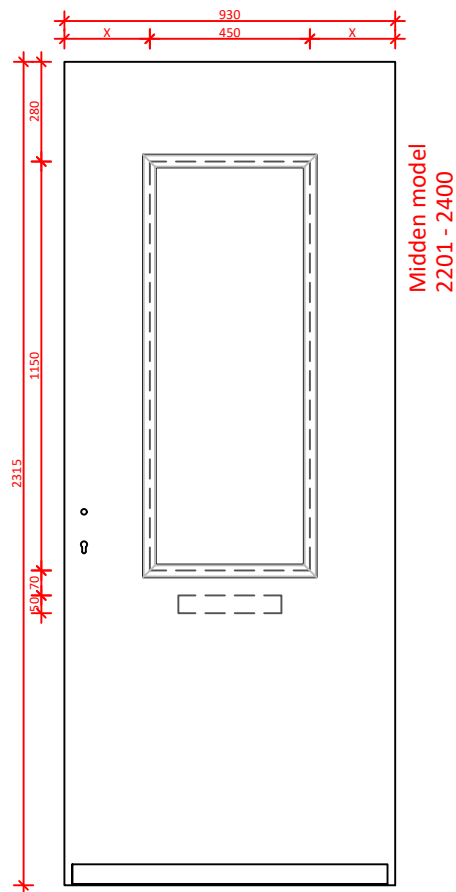
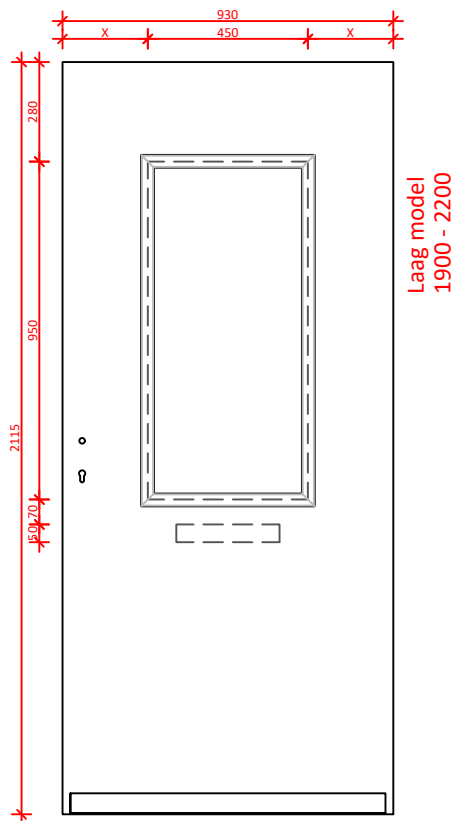
AANVRAAG:	SCHAAL:	GETEKEND: MN	LEVERWEEK: 1.2a P.29
-----------	---------	-----------------	-------------------------



DATUM:	GEWIJZIGD:	CALCULATIENR:	TEKENINGNR:	MODEL: 9196N	HOUTSOORT:
--------	------------	---------------	-------------	-----------------	------------

	KLANT/PROJECT: overzicht modellen 9196N			DCM NUMMER:
--	--	--	--	-------------

AANVRAAG:	SCHAAL:	GETEKEND: MN	LEVERWEEK:	1.2a P.30
-----------	---------	-----------------	------------	-----------

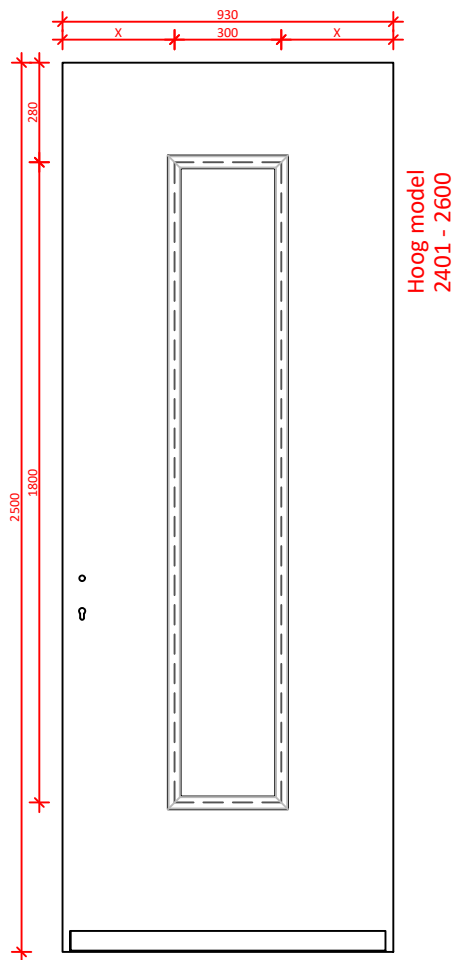
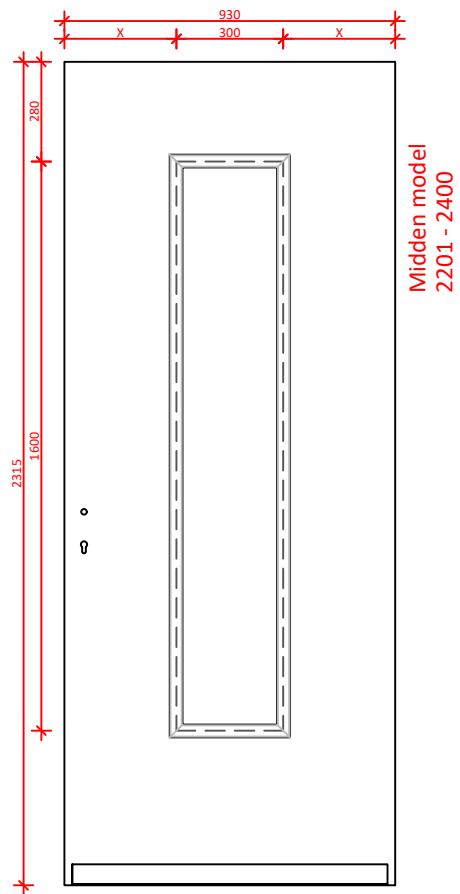
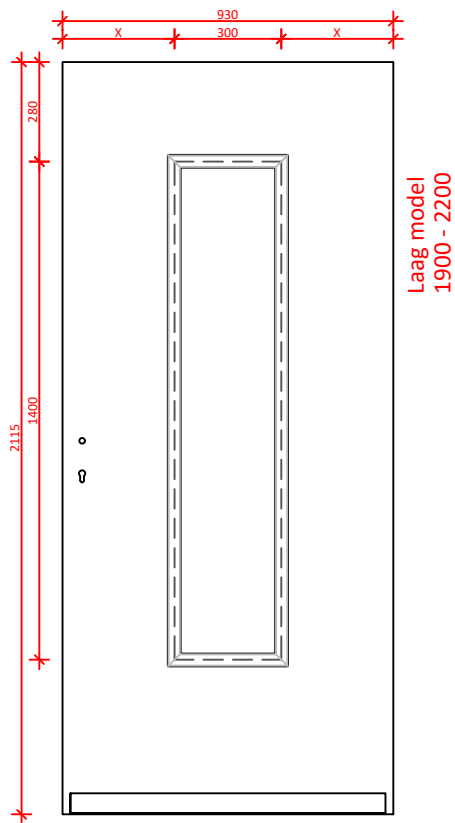

DATUM:	GEWIJZIGD:	CALCULATIENR:	TEKENINGNR:	MODEL: 9197N	HOUTSOORT:
--------	------------	---------------	-------------	-----------------	------------

	KLANT/PROJECT: overzicht modellen 9197N			DCM NUMMER:
--	--	--	--	-------------

AANVRAAG:	SCHAAL:	GETEKEND: MN	LEVERWEEK:	1.2a P.31
-----------	---------	-----------------	------------	-----------

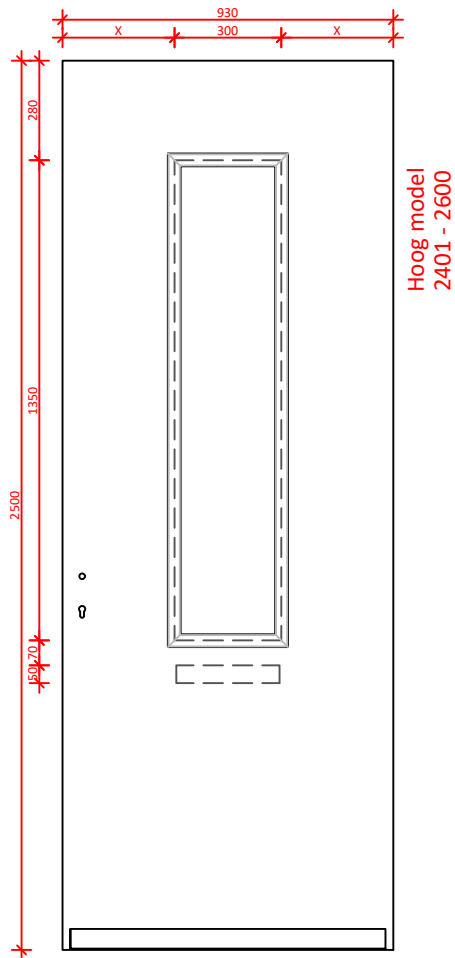
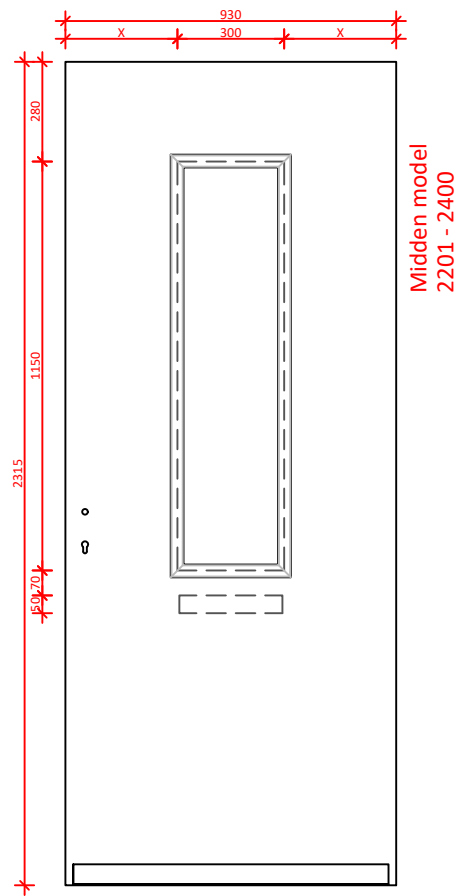
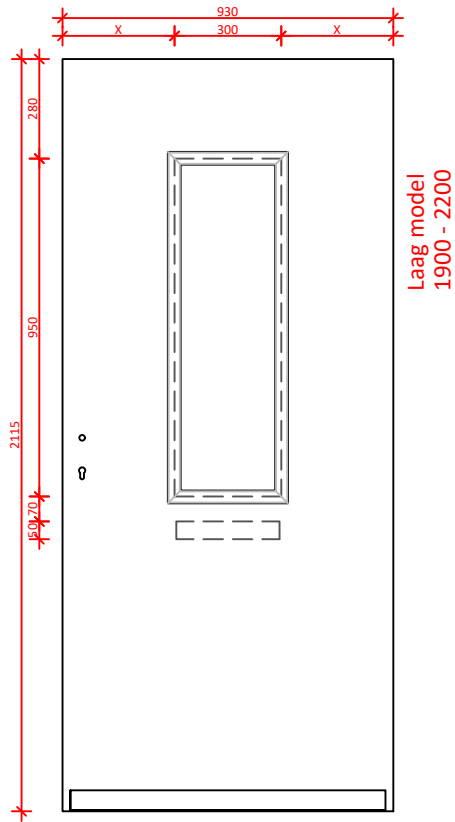

DATUM:	GEWIJZIGD:	CALCULATIENR:	TEKENINGNR:	MODEL: 9198N	HOUTSOORT:
--------	------------	---------------	-------------	-----------------	------------

	KLANT/PROJECT: overzicht modellen 9198N			DCM NUMMER:
--	--	--	--	-------------

AANVRAAG:	SCHAAL:	GETEKEND: MN	LEVERWEEK: 1.2a P.32
-----------	---------	-----------------	-------------------------

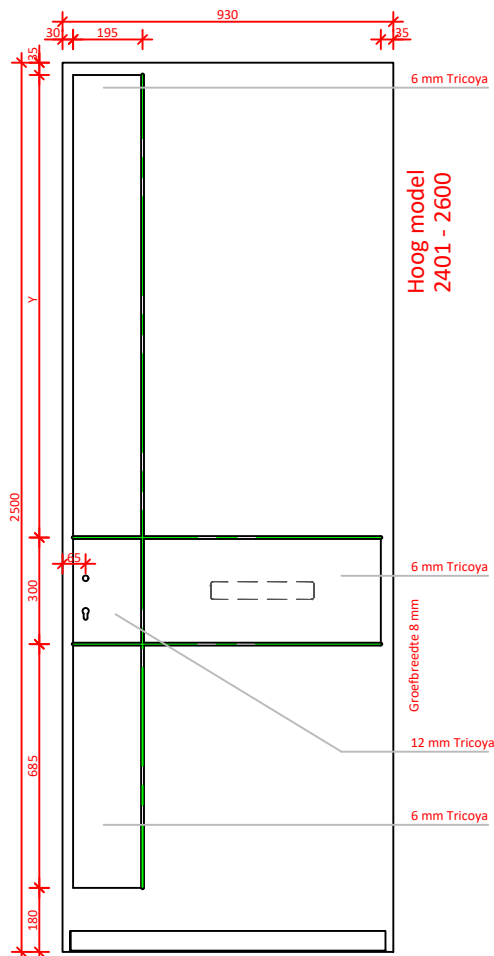
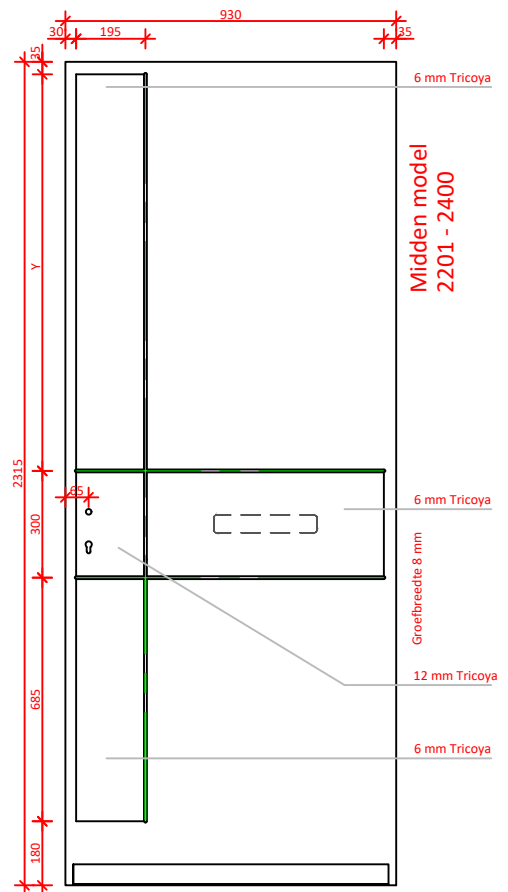
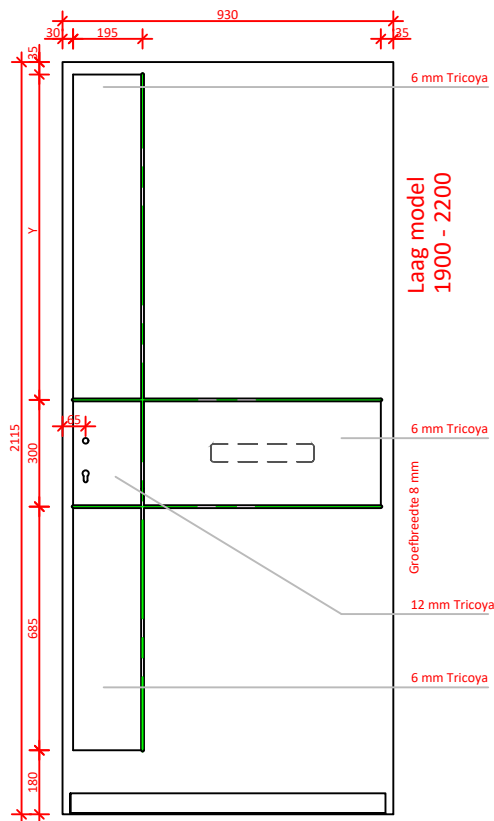

MAATVOERING WIJZIGT INDIEN SENIOREN SLOT WORDT TOEGEPAST  
MINIMAAL DOORNMAAT 65 TOEPASSEN IVM MOGELIJKE BVT OPLOSSING EN PLAATMATERIAAL

DATUM:	GEWIJZIGD:	CALCULATIENR:	TEKENINGNR:	MODEL: 9401	HOUTSOORT:
--------	------------	---------------	-------------	----------------	------------

	KLANT/PROJECT: overzicht modellen 9401 L1 - R4			DCM NUMMER:
--	---	--	--	-------------

AANVRAAG:	SCHAAL:	GETEKEND: MN	LEVERWEEK:	1.2a P.33
-----------	---------	-----------------	------------	-----------

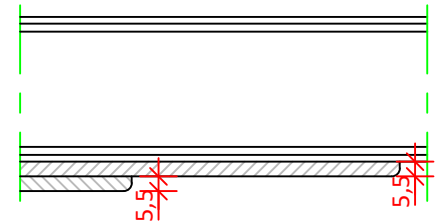
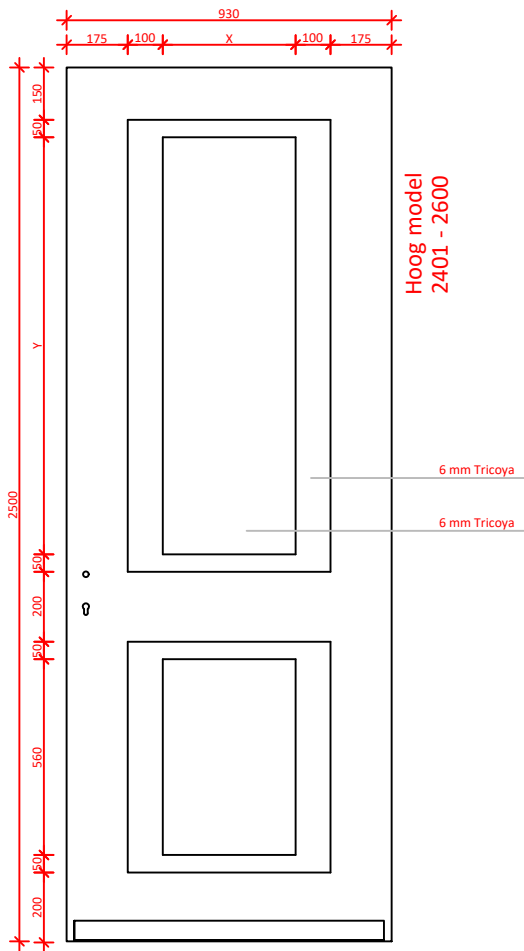
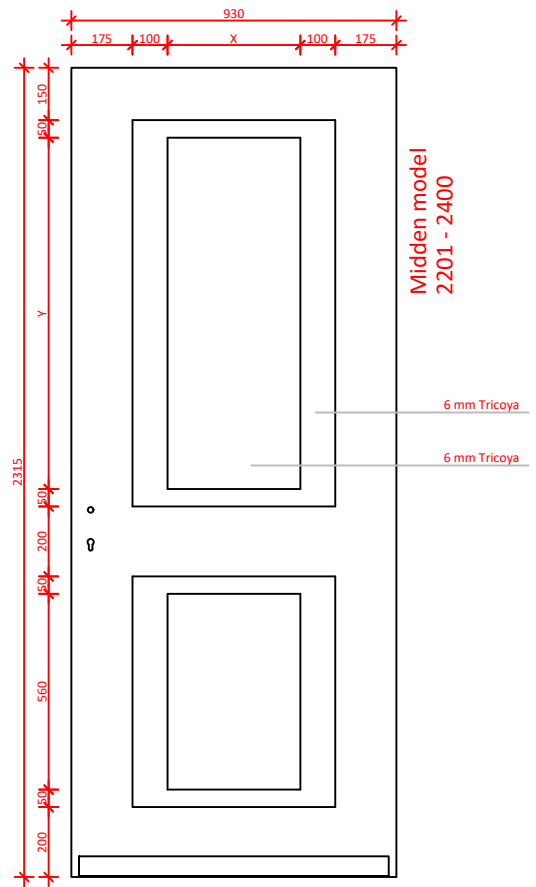
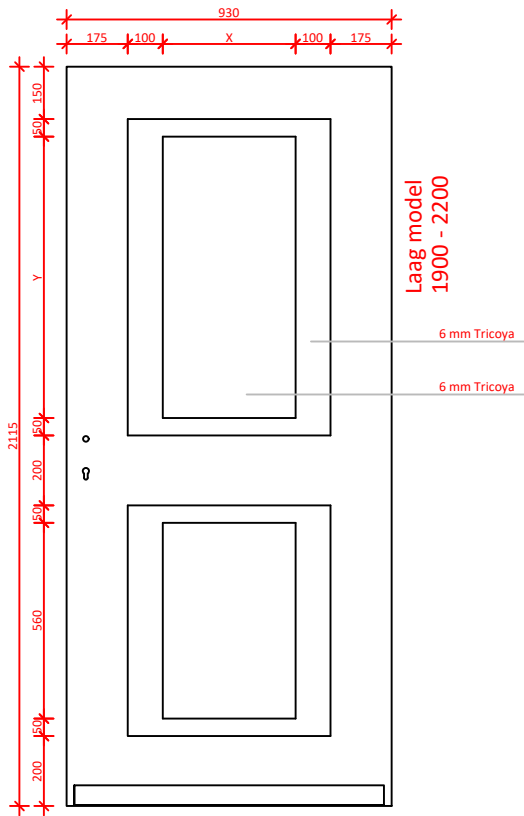

DATUM:	GEWIJZIGD:	CALCULATIENR:	TEKENINGNR:	MODEL: 9406	HOUTSOORT:
--------	------------	---------------	-------------	----------------	------------

	KLANT/PROJECT: overzicht modellen 9406			DCM NUMMER:
--	---	--	--	-------------

AANVRAAG:	SCHAAL:	GETEKEND: MN	LEVERWEEK:	1.2a P.34
-----------	---------	-----------------	------------	-----------

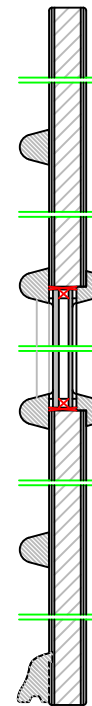
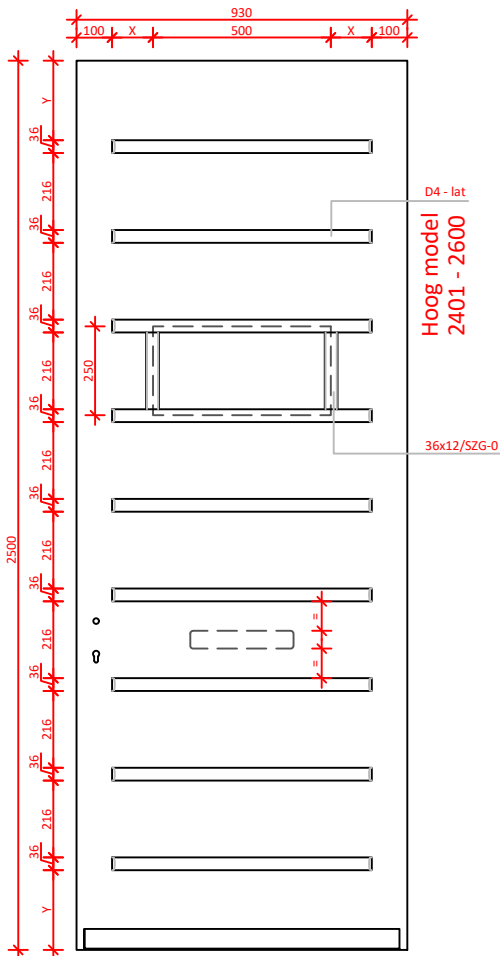
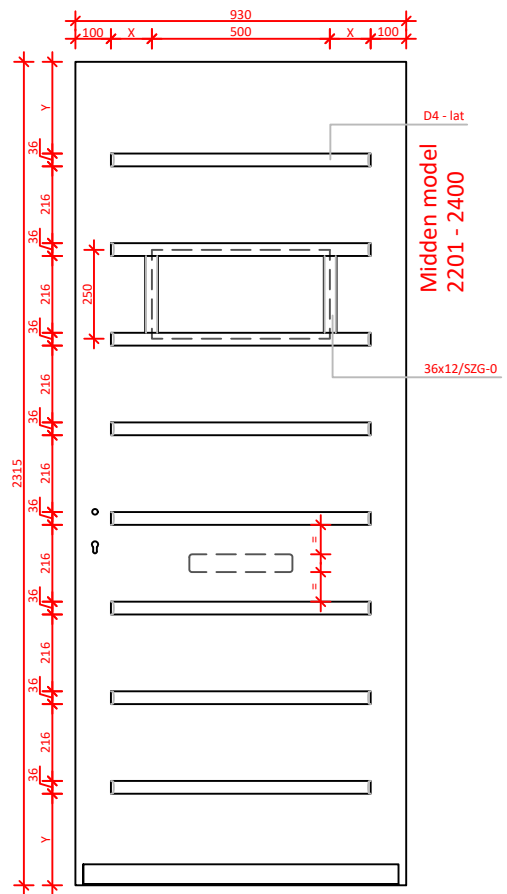
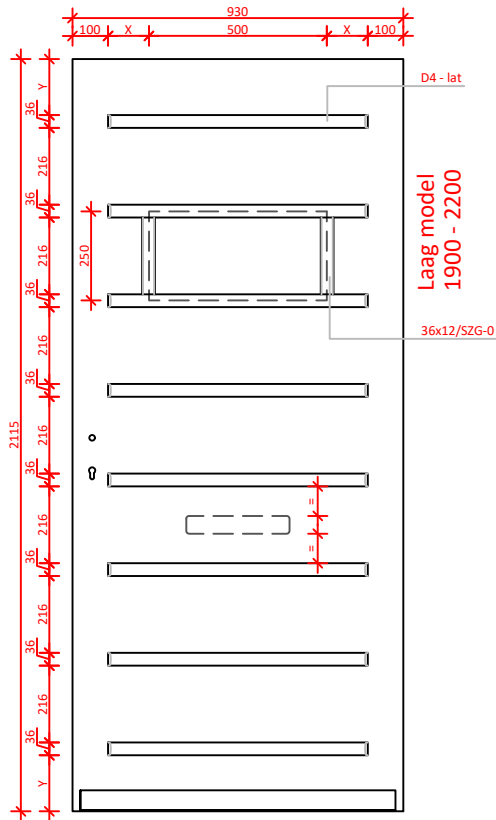

**Strakke SponningMaat**

- Pasmaat deurbreedte t/m 1000 mm : SSM 500mm
- Pasmaat deurbreedte 1001 t/m 1100 mm : SSM 600mm
- Pasmaat deurbreedte > 1101 mm : SSM 700mm

DATUM:	GEWIJZIGD:	CALCULATIENR:	TEKENINGNR:	MODEL: 9431N	HOUTSOORT:
			KLANT/PROJECT: overzicht modellen 9431N		DCM NUMMER:
			AANVRAAG:	SCHAAL:	GETEKEND: MN

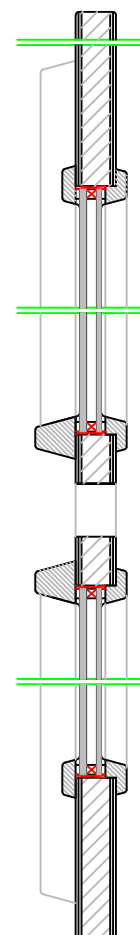
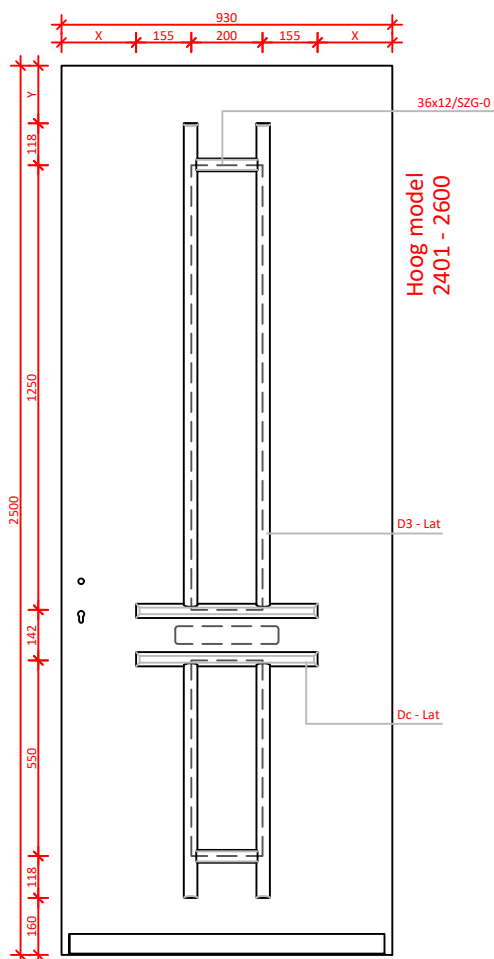
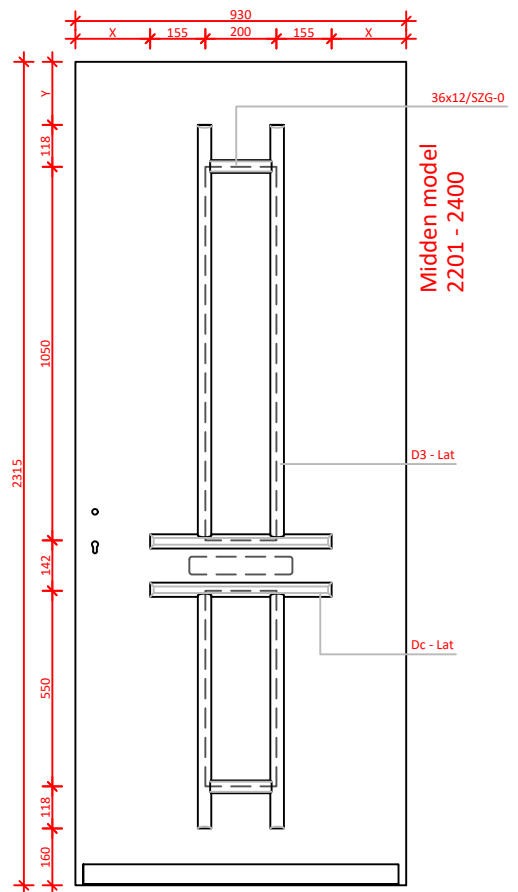
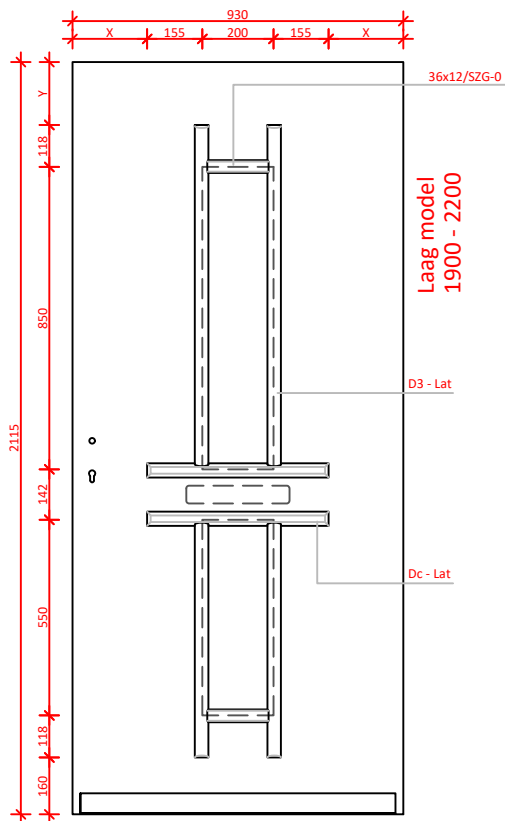

DATUM:	GEWIJZIGD:	CALCULATIENR:	TEKENINGNR:	MODEL: 9432N	HOUTSOORT:
--------	------------	---------------	-------------	-----------------	------------

	KLANT/PROJECT: overzicht modellen 9432N			DCM NUMMER:
--	--	--	--	-------------

AANVRAAG:	SCHAAL:	GETEKEND: MN	LEVERWEEK:	1.2a P.36
-----------	---------	-----------------	------------	-----------



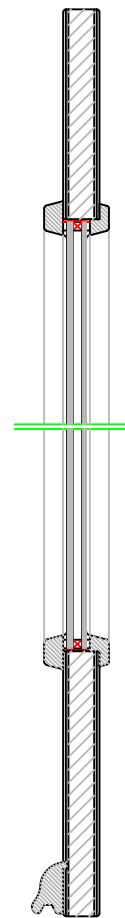
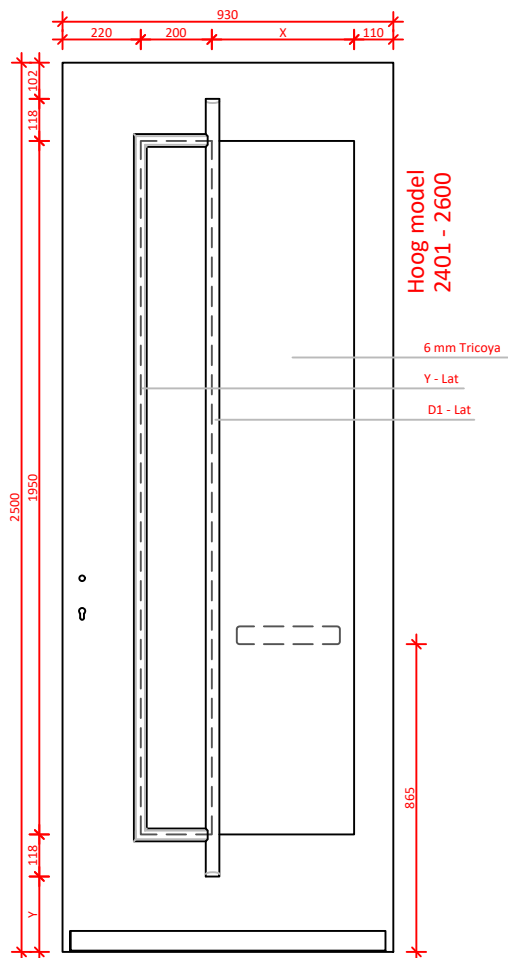
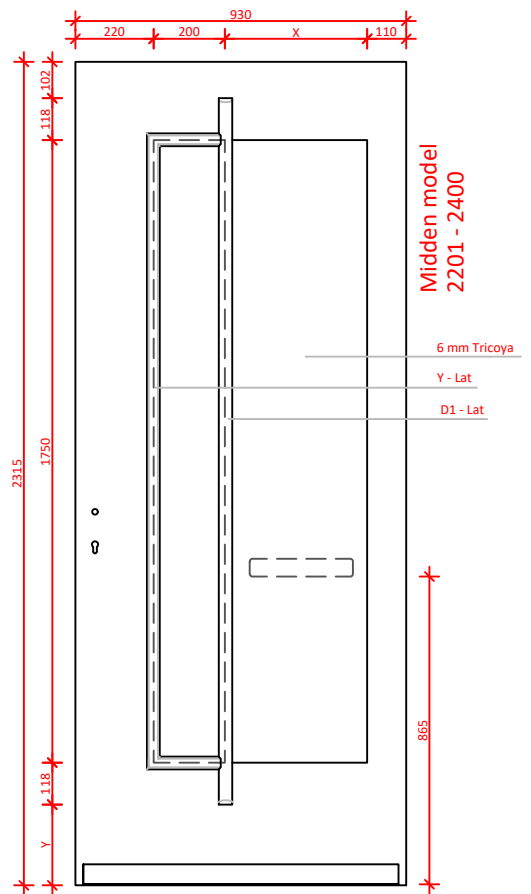
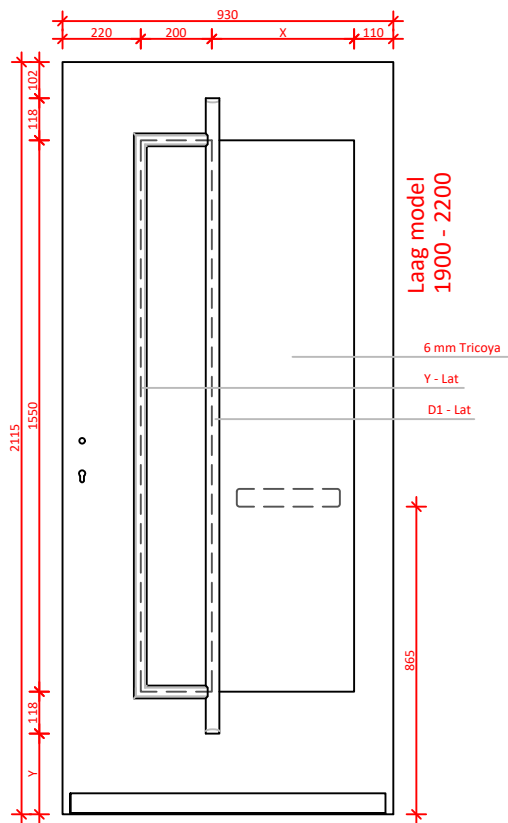

DATUM:	GEWIJZIGD:	CALCULATIENR:	TEKENINGNR:	MODEL: 9433N	HOUTSOORT:
--------	------------	---------------	-------------	-----------------	------------

<b>KEGRO   DEUREN</b>	KLANT/PROJECT: overzicht modellen 9433N L1 - R4			DCM NUMMER:
-----------------------	--	--	--	-------------

AANVRAAG:	SCHAAL:	GETEKEND: MN	LEVERWEEK: 1.2a P.37
-----------	---------	-----------------	-------------------------

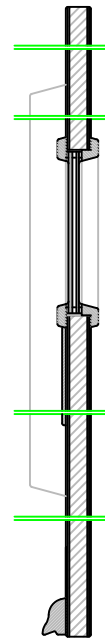
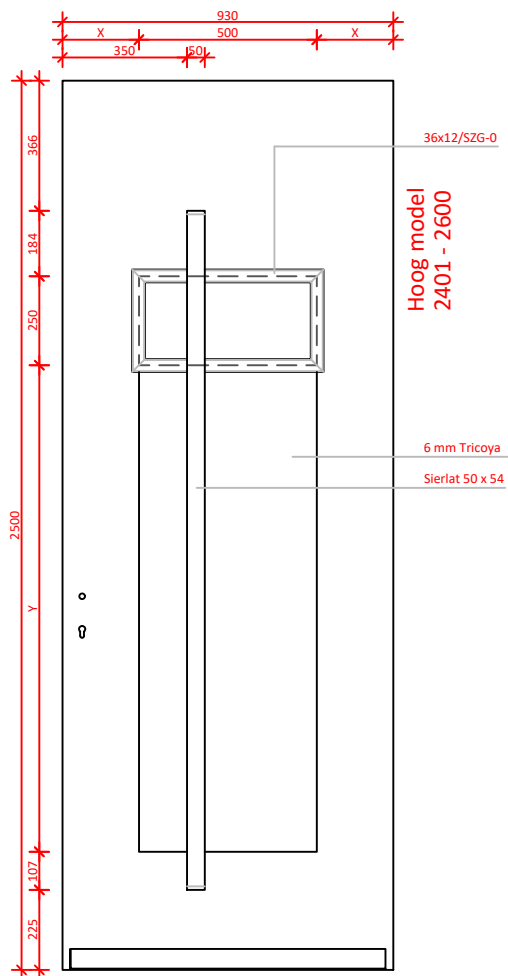
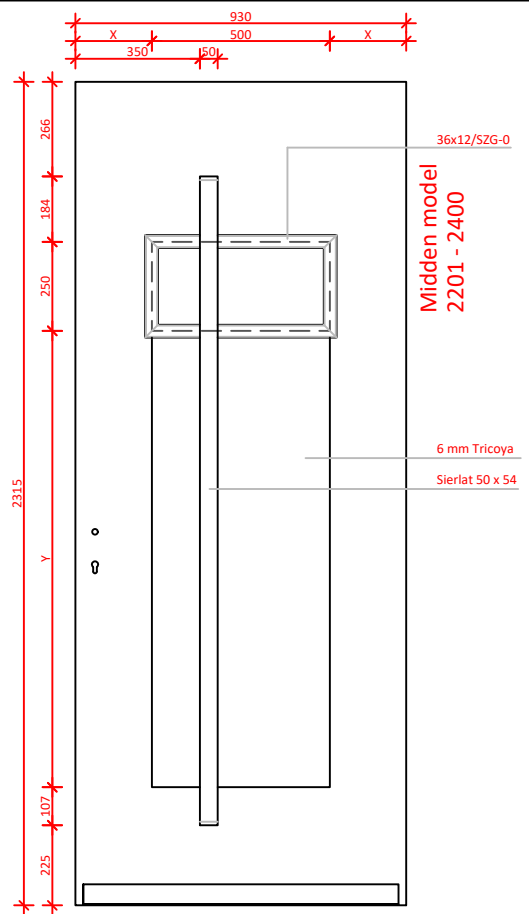
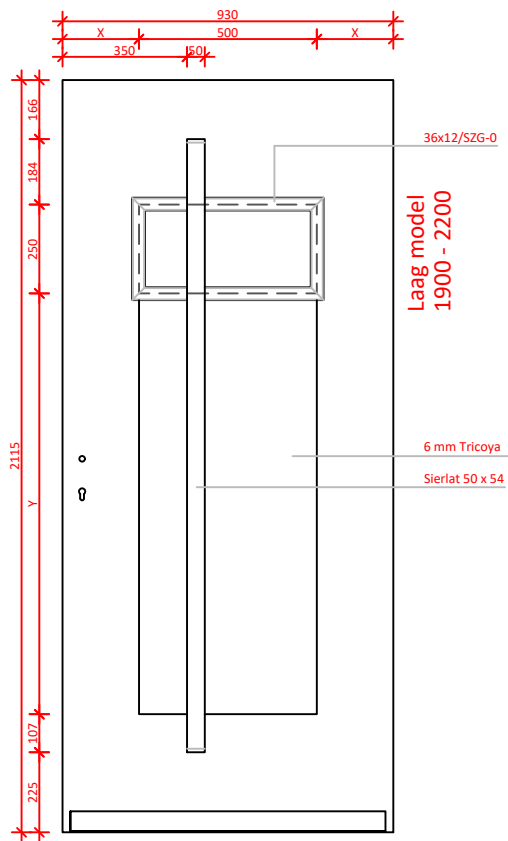

Strakke SponningMaat  
 Pasmaat deurbreedte t/m 1000 mm : SSM 500mm  
 Pasmaat deurbreedte 1001 t/m 1100 mm : SSM 600mm  
 Pasmaat deurbreedte > 1101 mm : SSM 700mm

DATUM:	GEWIJZIGD:	CALCULATIENR:	TEKENINGNR:	MODEL: 9434N	HOUTSOORT:
--------	------------	---------------	-------------	-----------------	------------

	KLANT/PROJECT: overzicht modellen 9434N L1 - R4			DCM NUMMER:
--	--	--	--	-------------

AANVRAAG:	SCHAAL:	GETEKEND: MN	LEVERWEEK: 1.2a P.38
-----------	---------	-----------------	-------------------------

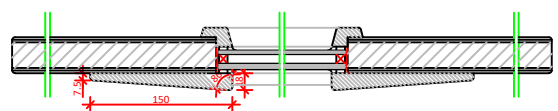
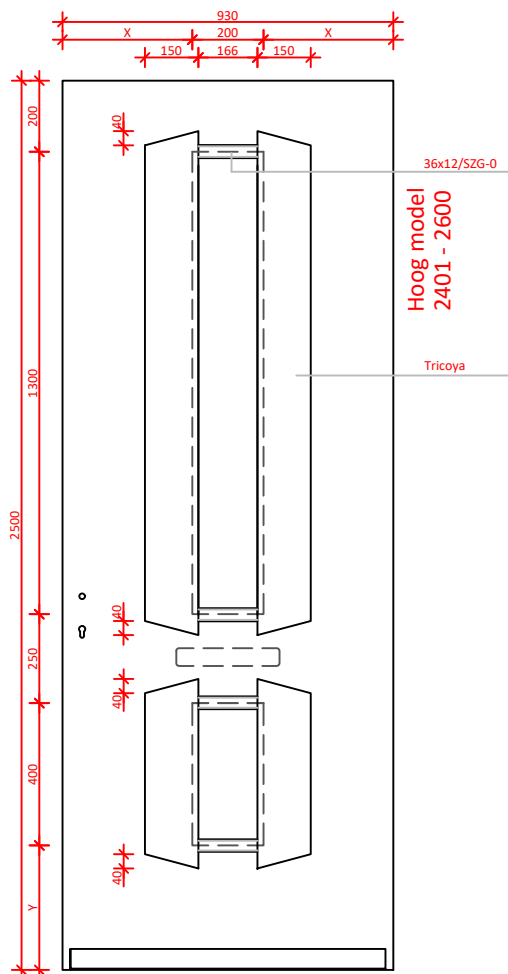
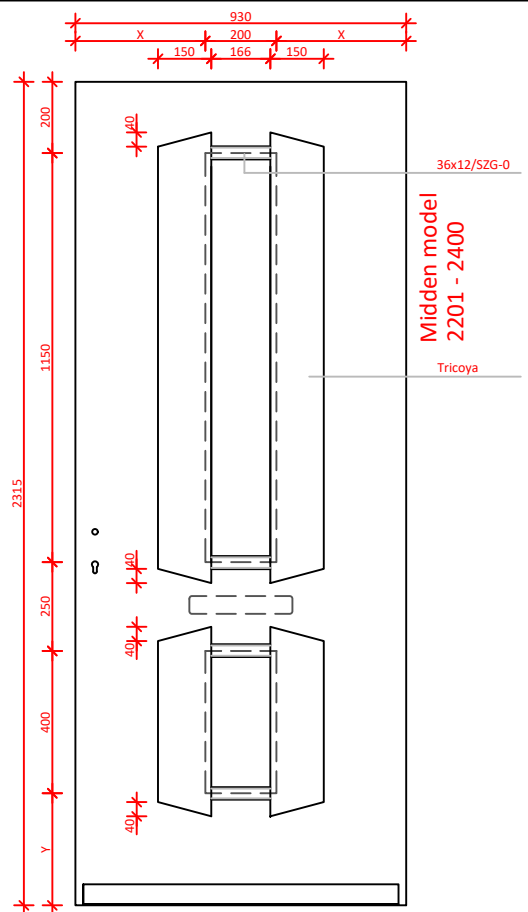
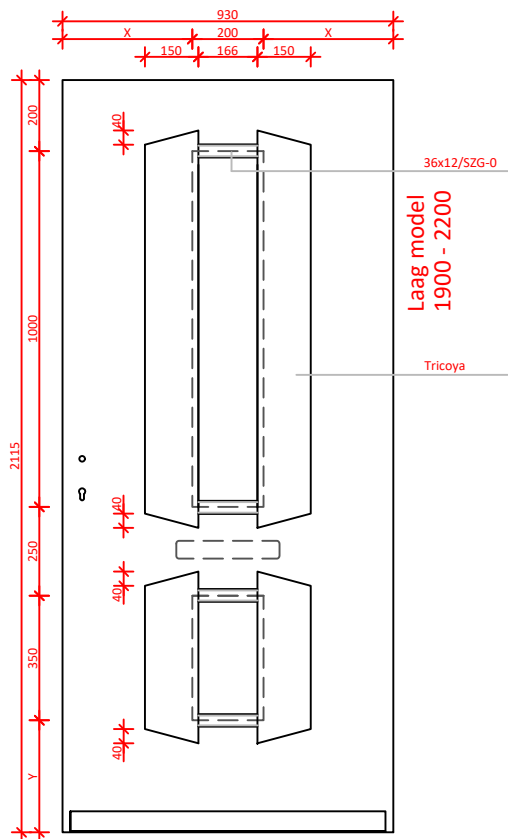

DATUM:	GEWIJZIGD:	CALCULATIENR:	TEKENINGNR:	MODEL: 9435N	HOUTSOORT:
--------	------------	---------------	-------------	-----------------	------------

	KLANT/PROJECT: overzicht modellen 9435N			DCM NUMMER:
--	--	--	--	-------------

AANVRAAG:	SCHAAL:	GETEKEND: MN	LEVERWEEK:	1.2a P.39
-----------	---------	-----------------	------------	-----------

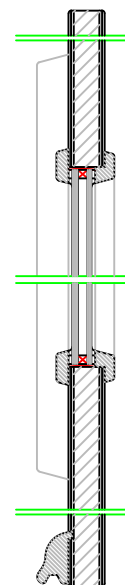
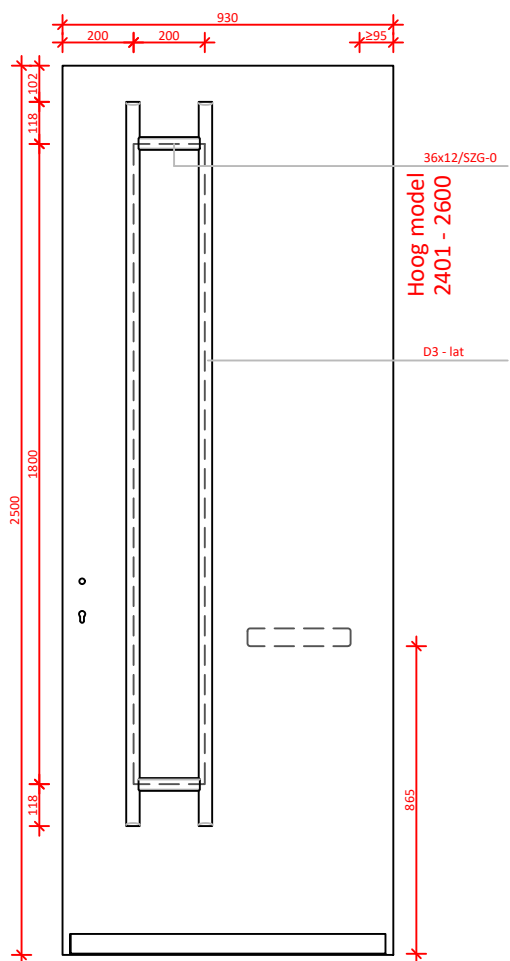
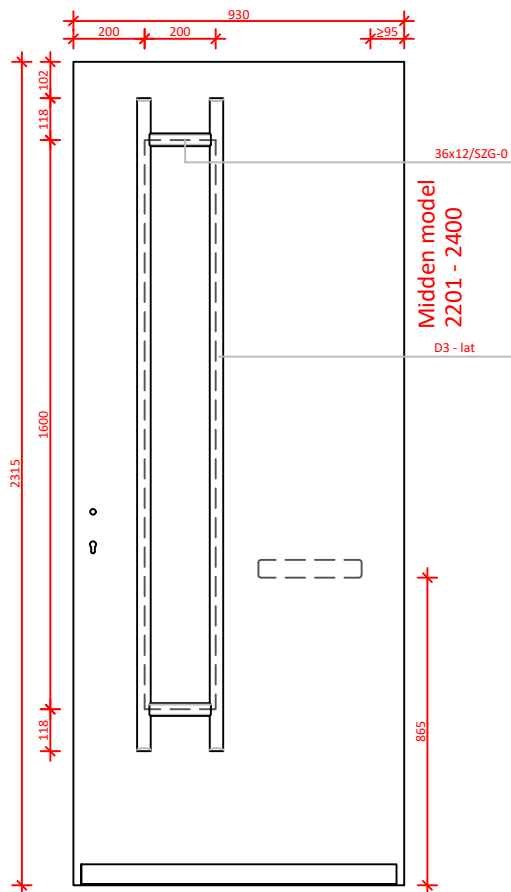
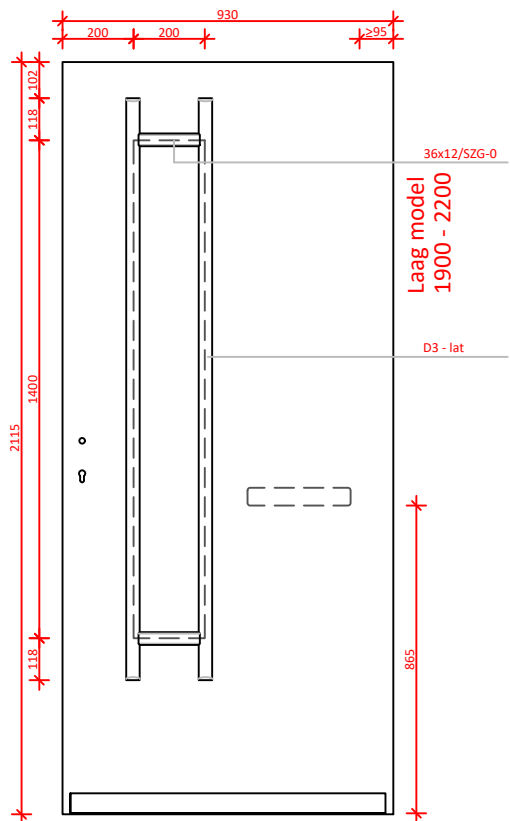

DATUM:	GEWIJZIGD:	CALCULATIENR:	TEKENINGNR:	MODEL: 9436N	HOUTSOORT:
--------	------------	---------------	-------------	-----------------	------------

	KLANT/PROJECT: overzicht modellen 9436N			DCM NUMMER:
--	--	--	--	-------------

AANVRAAG:	SCHAAL:	GETEKEND: MN	LEVERWEEK:	1.2a P.40
-----------	---------	-----------------	------------	-----------

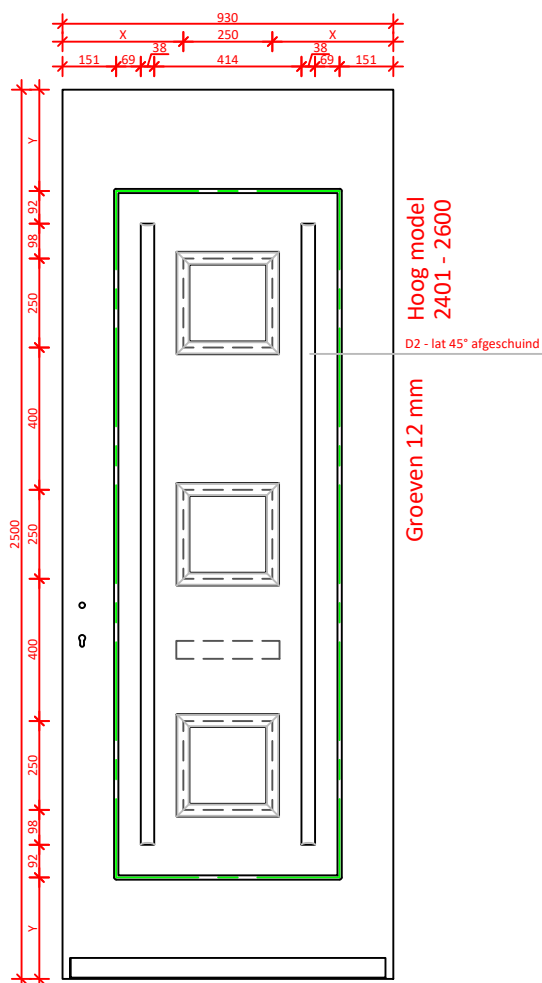
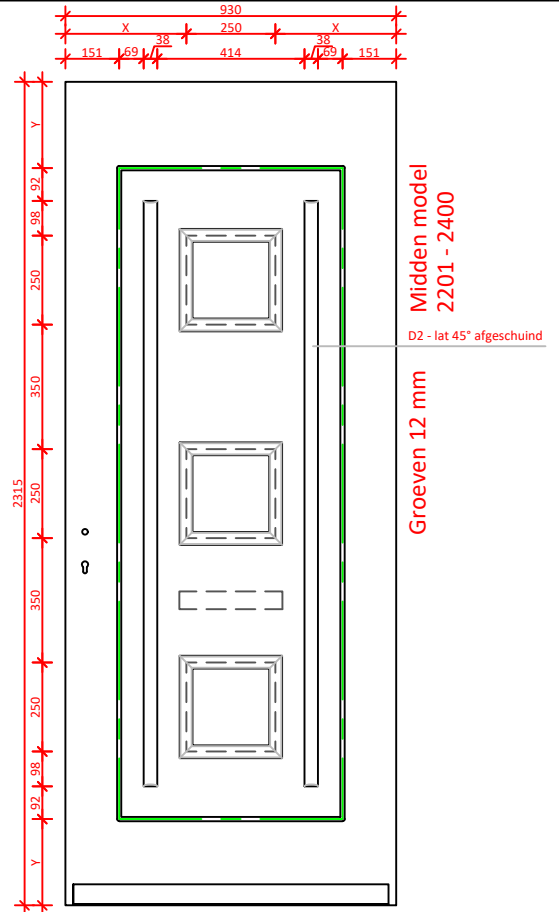
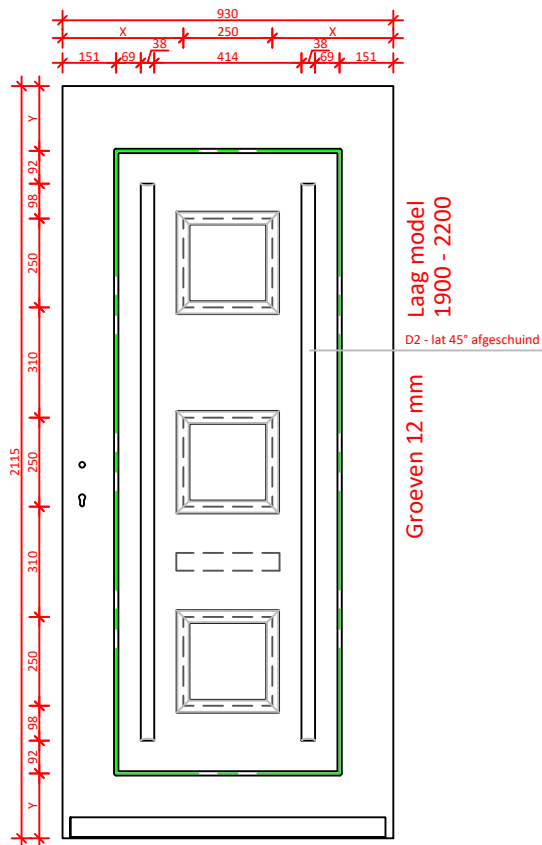

DATUM:	GEWIJZIGD:	CALCULATIENR:	TEKENINGNR:	MODEL: 9460N	HOUTSOORT:
--------	------------	---------------	-------------	-----------------	------------

	KLANT/PROJECT: overzicht modellen 9460N			DCM NUMMER:
--	--	--	--	-------------

AANVRAAG:	SCHAAL:	GETEKEND: MN	LEVERWEEK:	1.2a P.41
-----------	---------	-----------------	------------	-----------

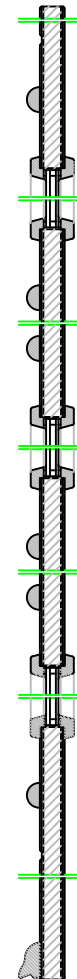
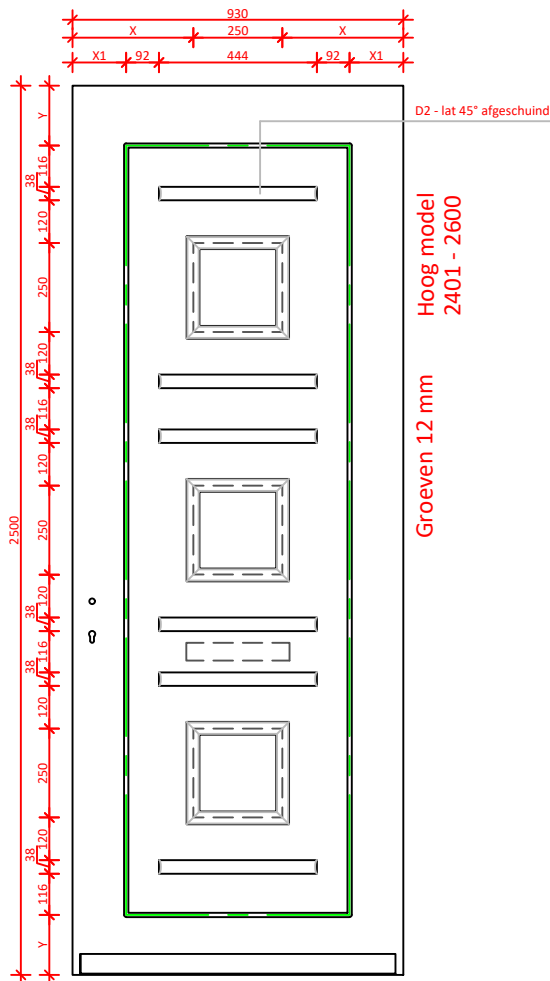
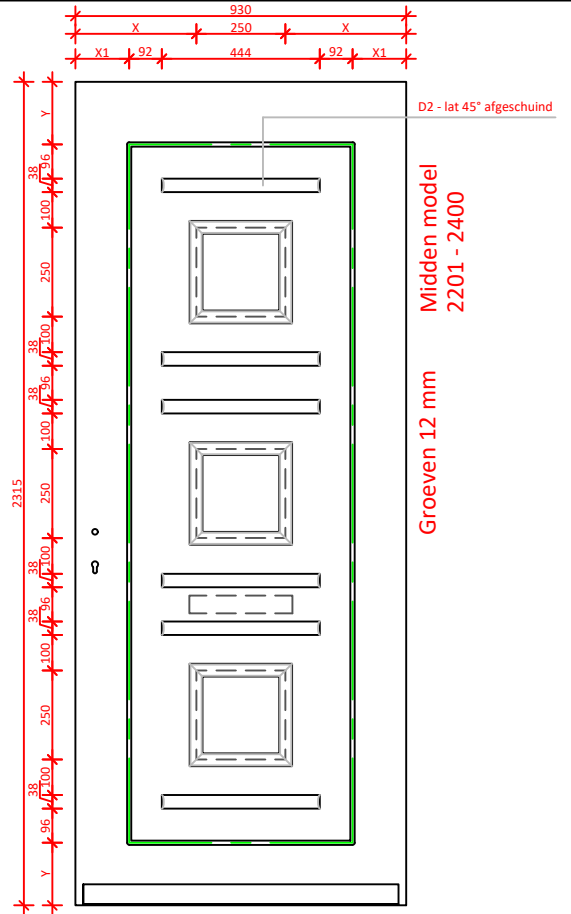
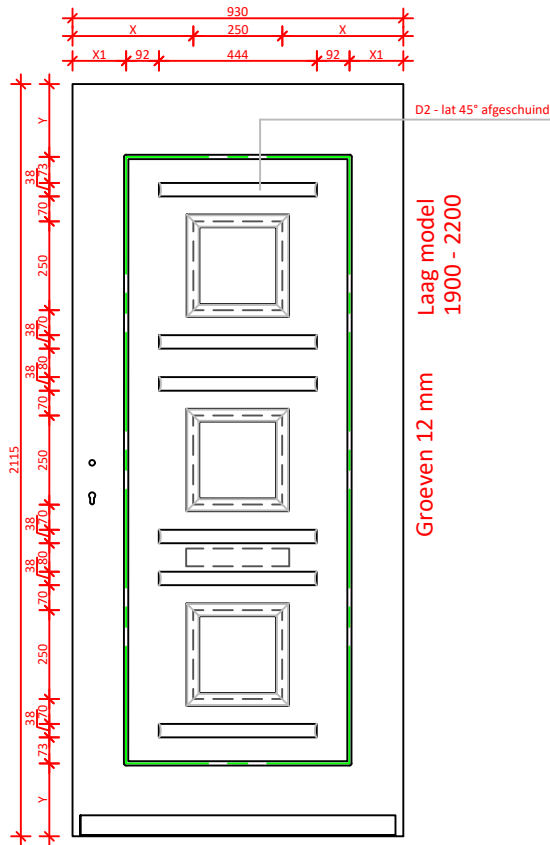

DATUM:	GEWIJZIGD:	CALCULATIENR:	TEKENINGNR:	MODEL: 9461N	HOUTSOORT:
--------	------------	---------------	-------------	-----------------	------------

<b>KEGRO</b>   <b>DEUREN</b>	KLANT/PROJECT: overzicht modellen 9461N			DCM NUMMER:
------------------------------	--	--	--	-------------

AANVRAAG:	SCHAAL:	GETEKEND: MN	LEVERWEEK:	1.2a P.42
-----------	---------	-----------------	------------	-----------

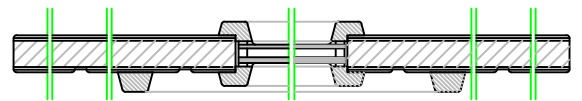
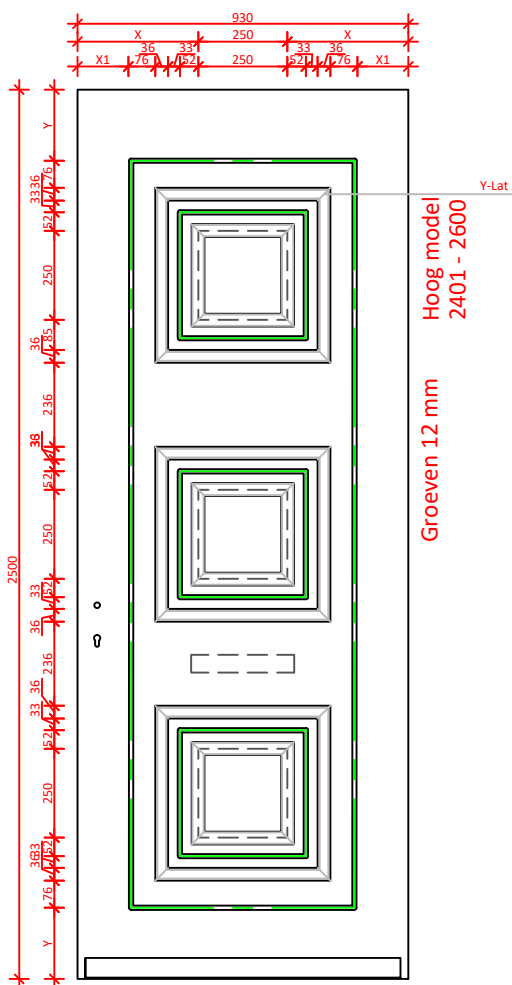
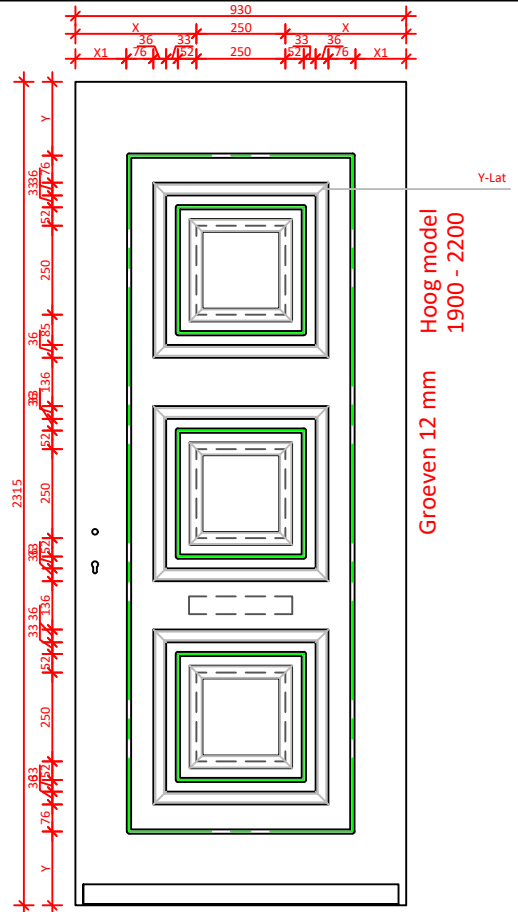
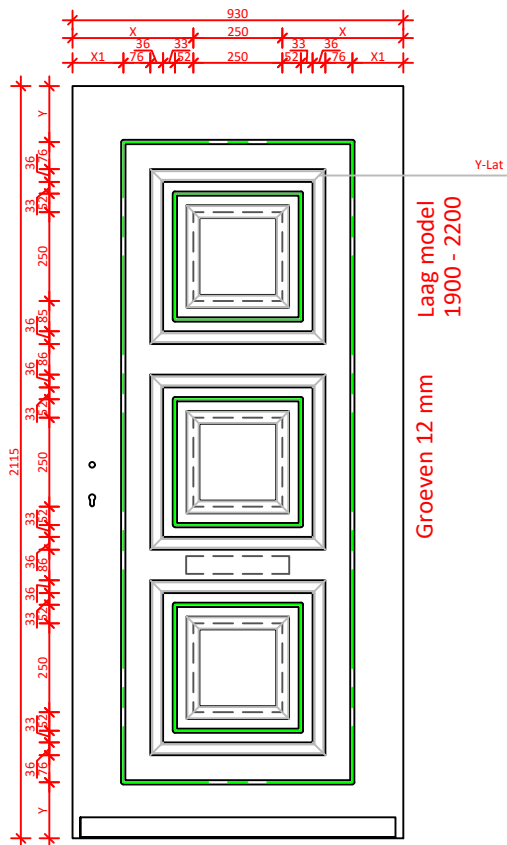

DATUM:	GEWIJZIGD:	CALCULATIENR:	TEKENINGNR:	MODEL: 9462N	HOUTSOORT:
--------	------------	---------------	-------------	-----------------	------------

	KLANT/PROJECT: overzicht modellen 9462N			DCM NUMMER:
--	--	--	--	-------------

AANVRAAG:	SCHAAL:	GETEKEND: MN	LEVERWEEK:	1.2a P.43
-----------	---------	-----------------	------------	-----------

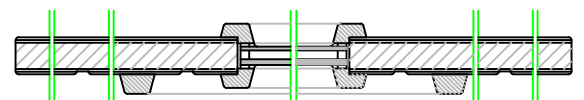
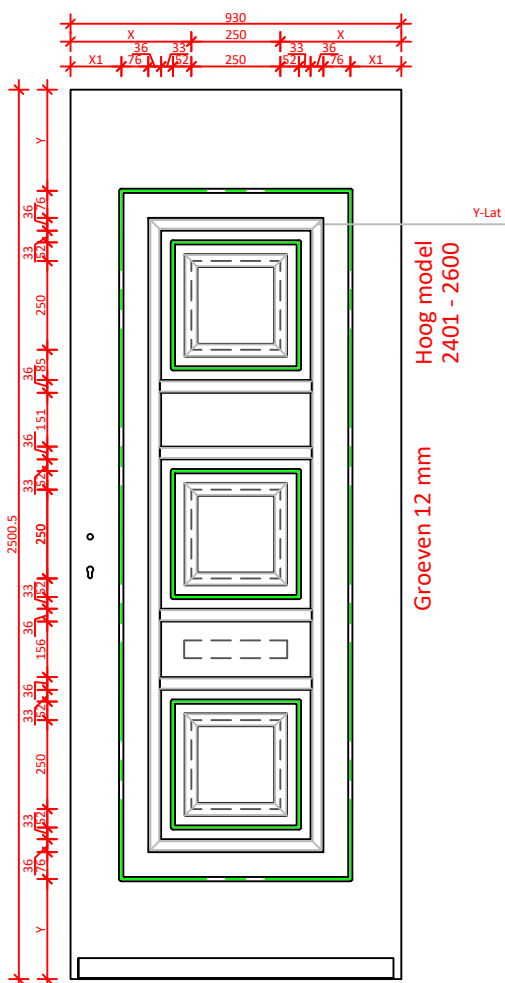
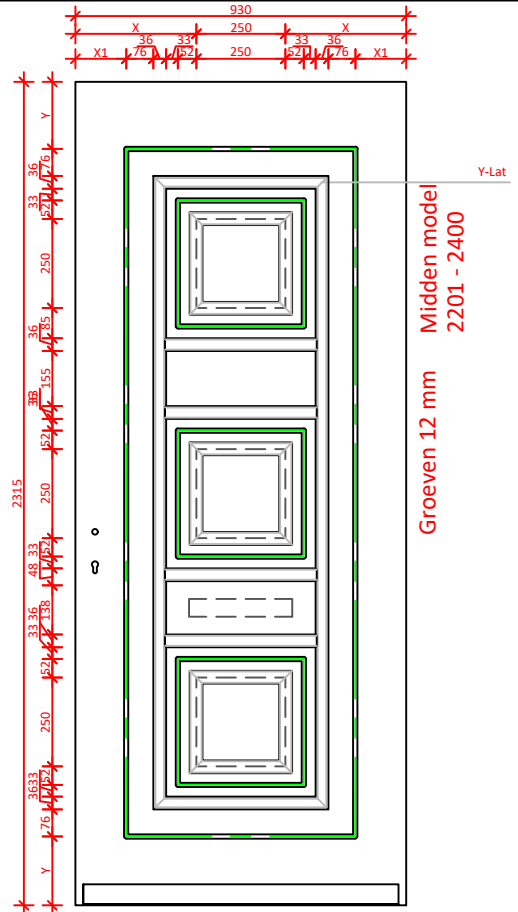
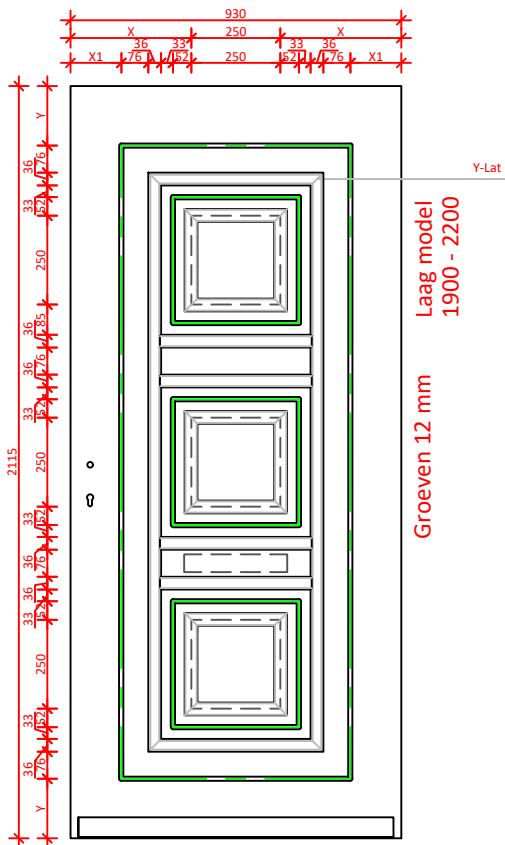

DATUM:	GEWIJZIGD:	CALCULATIENR:	TEKENINGNR:	MODEL: 9463N	HOUTSOORT:
--------	------------	---------------	-------------	-----------------	------------



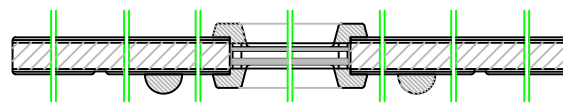
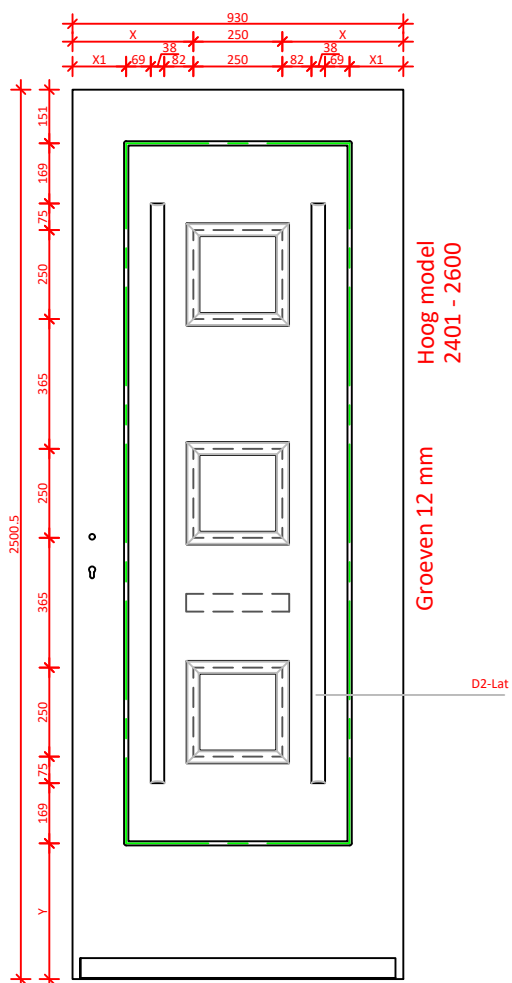
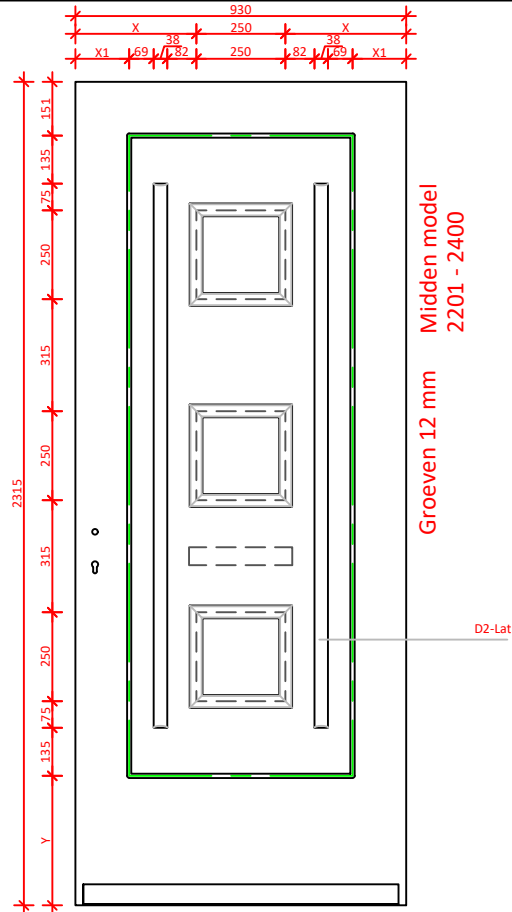
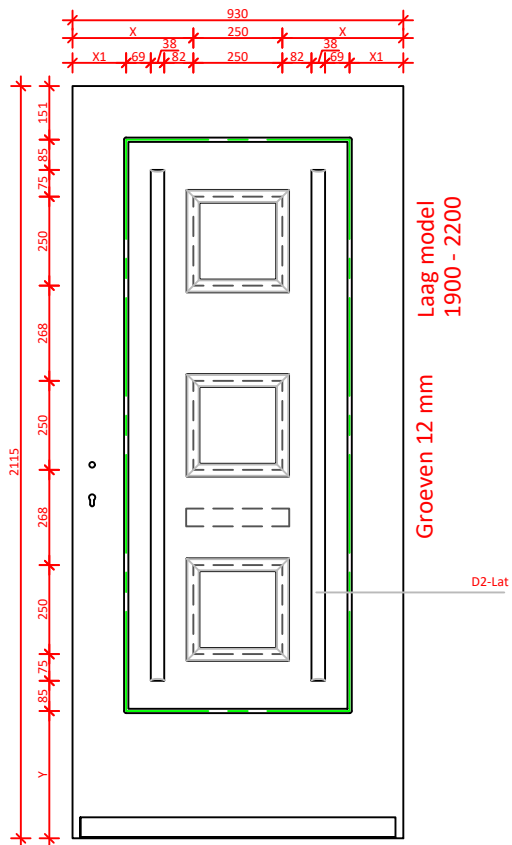

DATUM:	GEWIJZIGD:	CALCULATIENR:	TEKENINGNR:	MODEL: 9464N	HOUTSOORT:
--------	------------	---------------	-------------	-----------------	------------

	KLANT/PROJECT: overzicht modellen 9464N			DCM NUMMER:
--	--	--	--	-------------

AANVRAAG:	SCHAAL:	GETEKEND: MN	LEVERWEEK:	1.2a P.45
-----------	---------	-----------------	------------	-----------



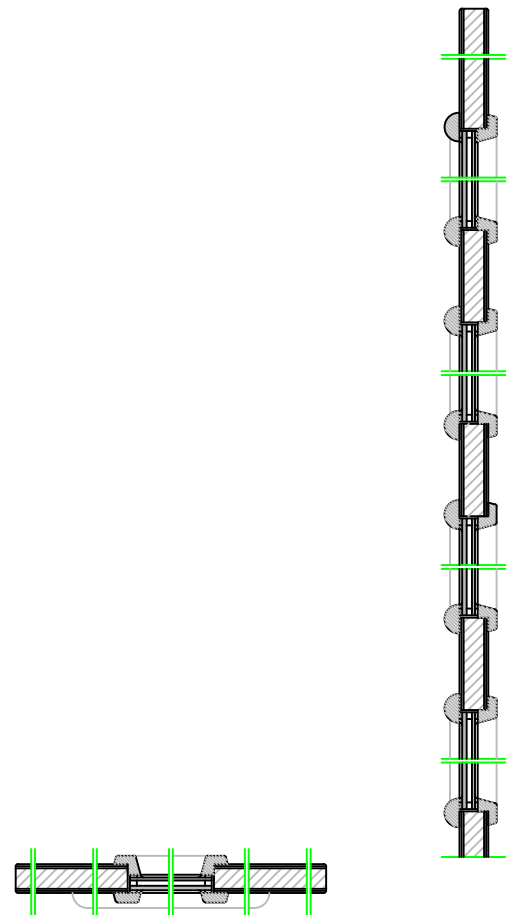
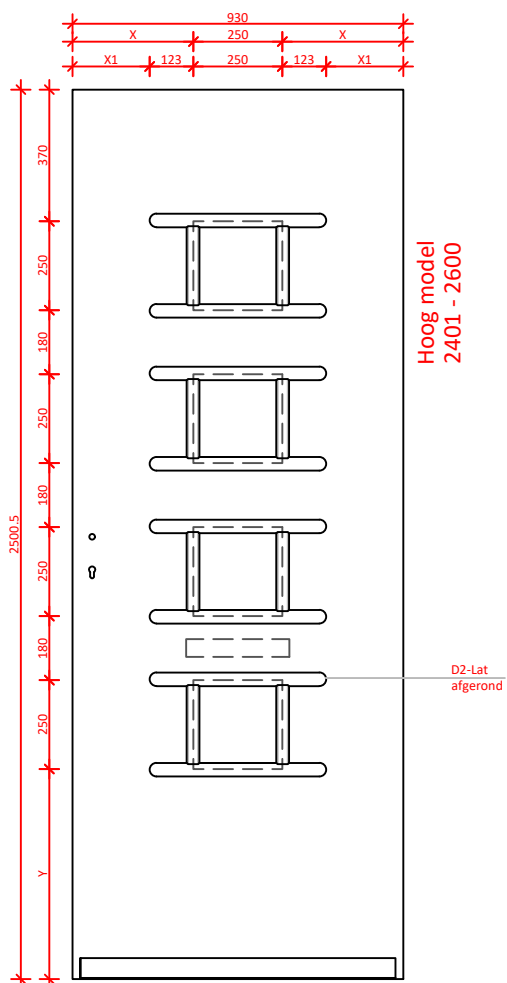
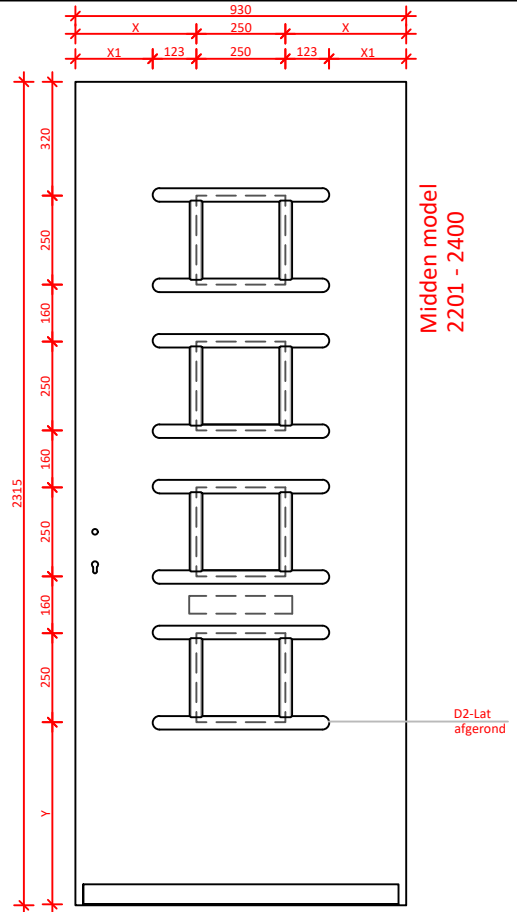
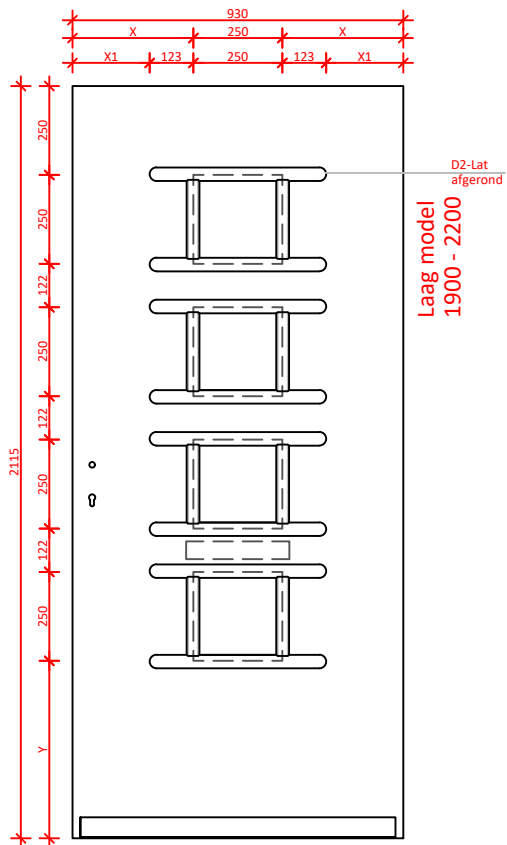

DATUM:	GEWIJZIGD:	CALCULATIENR:	TEKENINGNR:	MODEL: 9466N	HOUTSOORT:
--------	------------	---------------	-------------	-----------------	------------

	KLANT/PROJECT: overzicht modellen 9466N			DCM NUMMER:
--	--	--	--	-------------

AANVRAAG:	SCHAAL:	GETEKEND: MN	LEVERWEEK:	1.2a P.47
-----------	---------	-----------------	------------	-----------



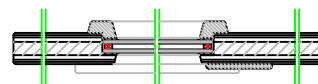
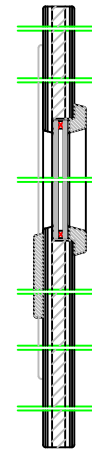
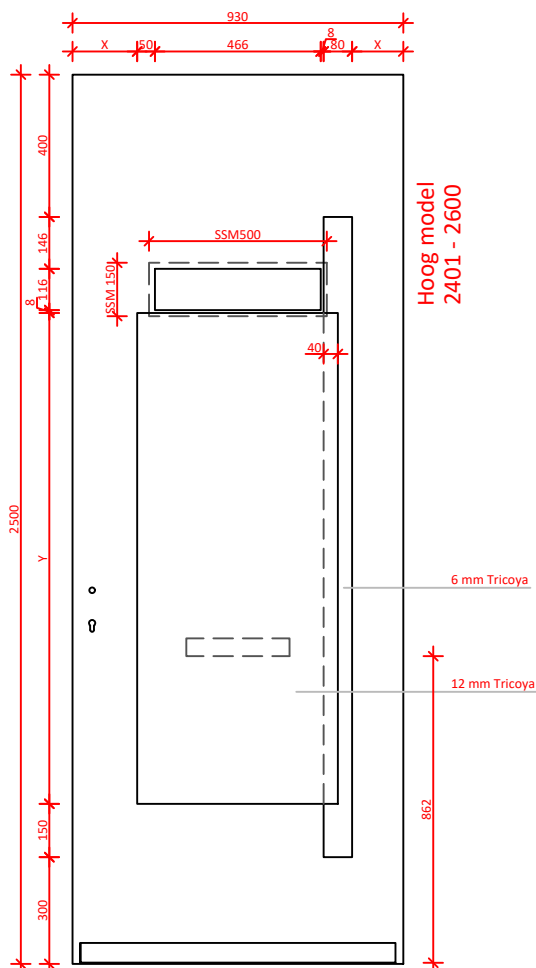
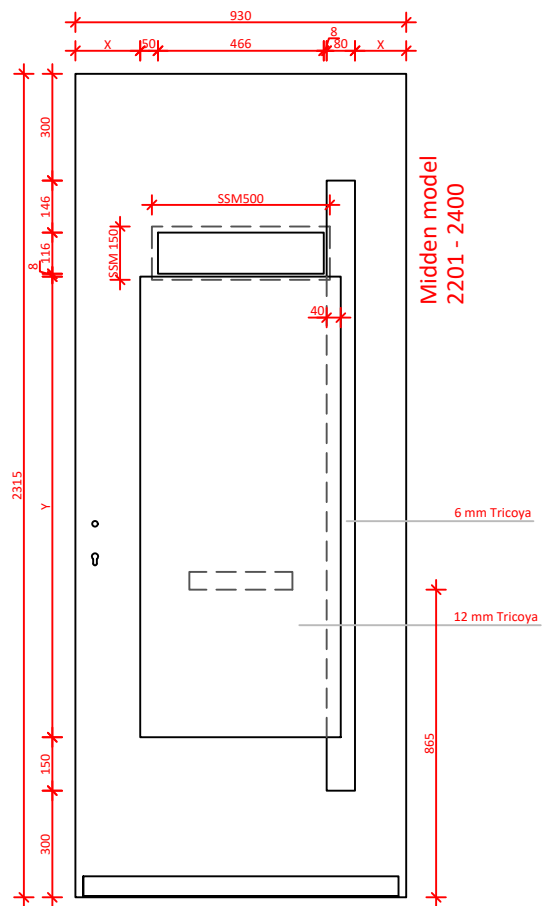
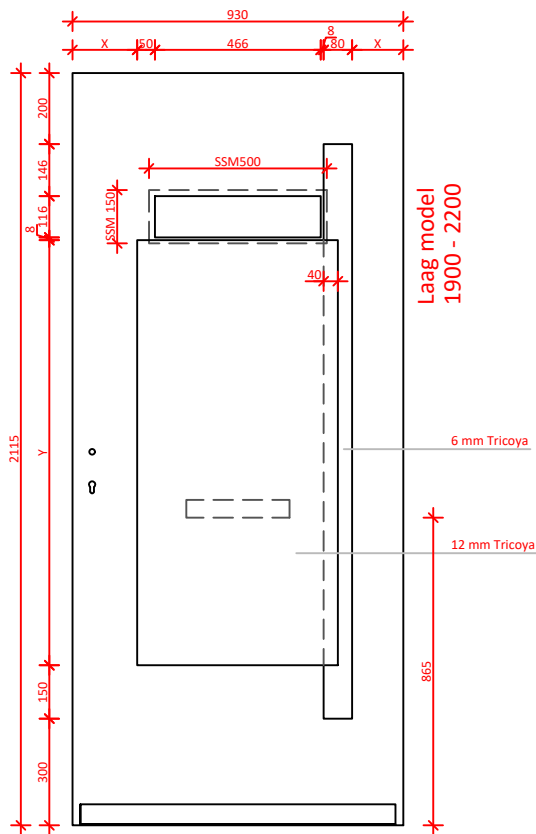

Strakke SponningMaat  
 Pasmaat deurbreedte t/m 1000 mm : SSM 500mm  
 Pasmaat deurbreedte 1001 t/m 1100 mm : SSM 600mm  
 Pasmaat deurbreedte > 1101 mm : SSM 700mm

DATUM:	GEWIJZIGD:	CALCULATIENR:	TEKENINGNR:	MODEL: 9501N	HOUTSOORT:
--------	------------	---------------	-------------	-----------------	------------

	KLANT/PROJECT: overzicht modellen 9501N met briefsleuf			DCM NUMMER:
--	---	--	--	-------------

AANVRAAG:	SCHAAL:	GETEKEND: MN	LEVERWEEK: 1.2a P.49
-----------	---------	-----------------	-------------------------

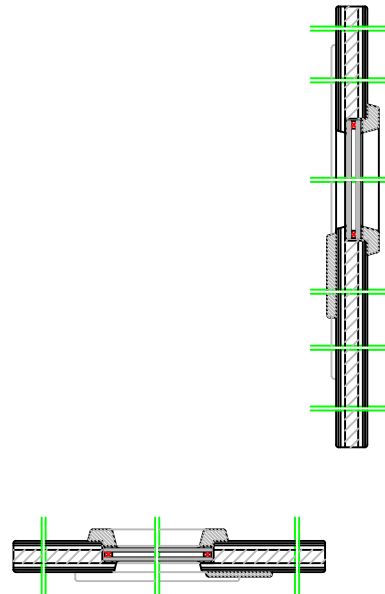
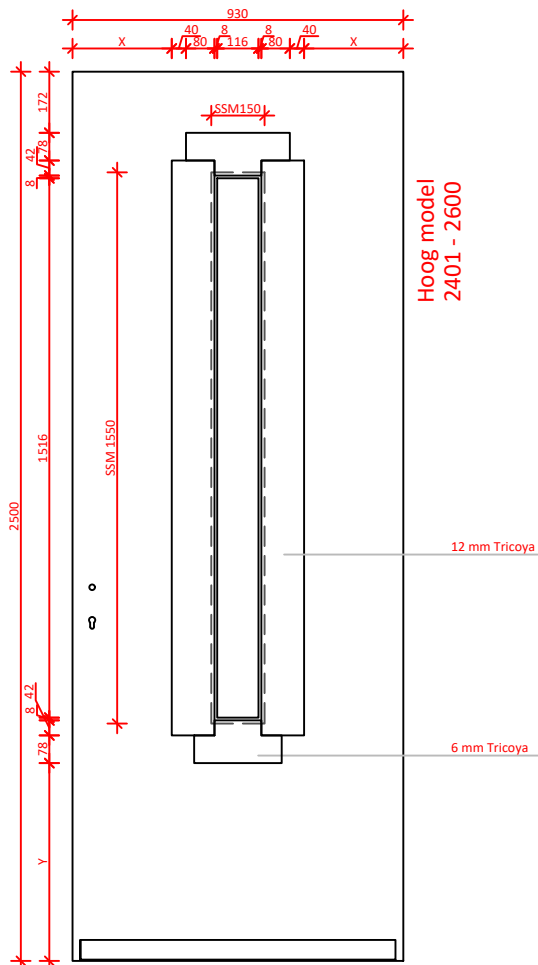
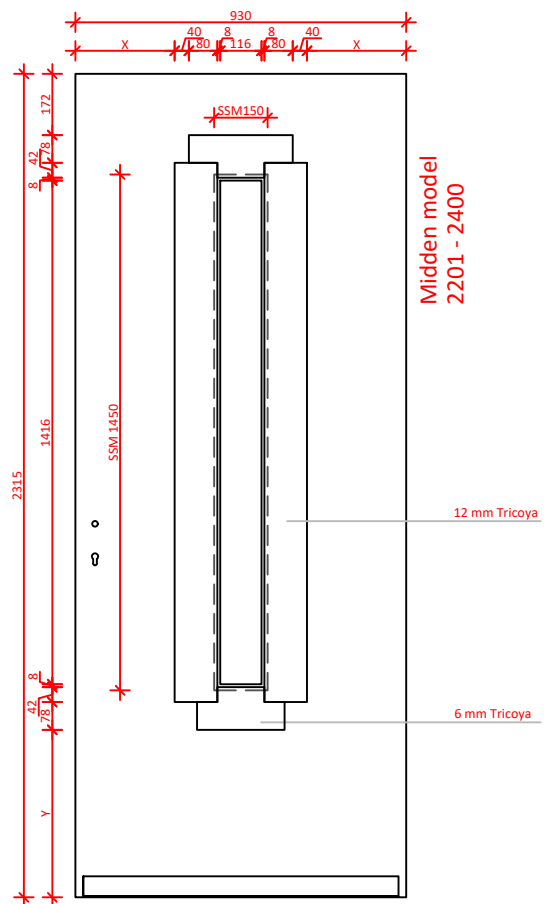
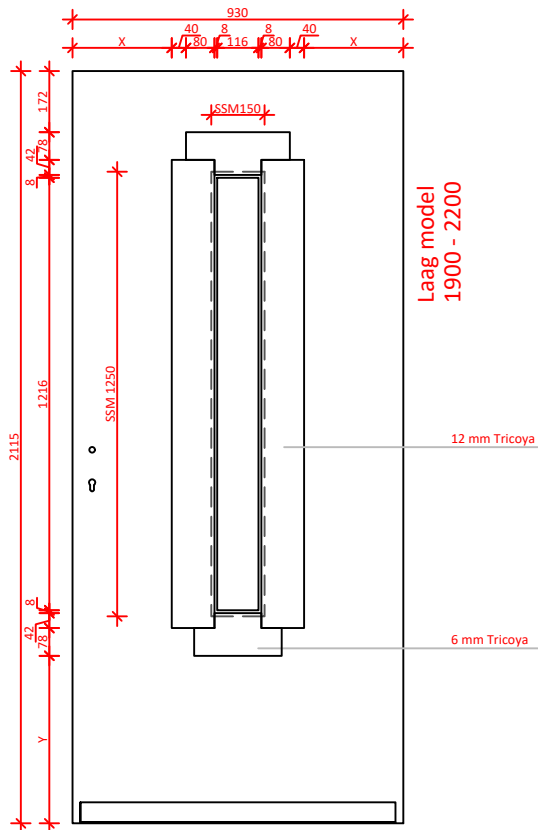

DATUM:	GEWIJZIGD:	CALCULATIENR:	TEKENINGNR:	MODEL: 9502N	HOUTSOORT:
--------	------------	---------------	-------------	-----------------	------------

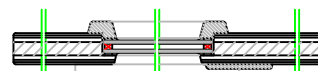
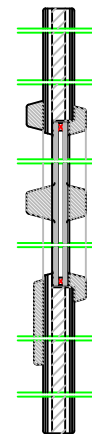
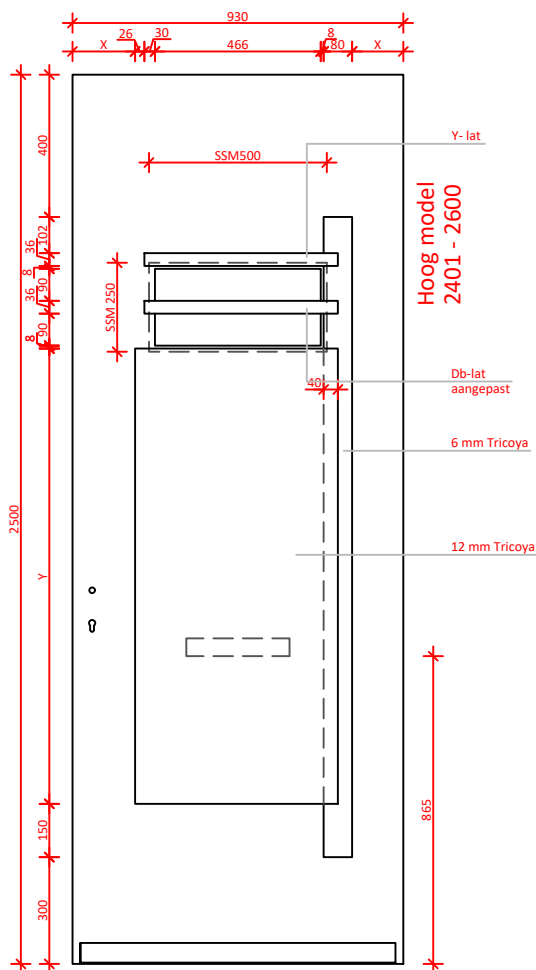
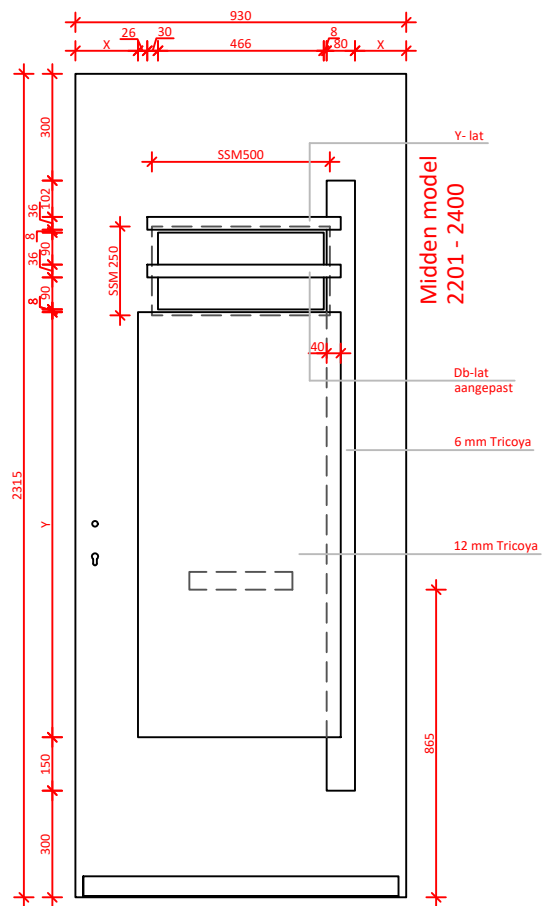
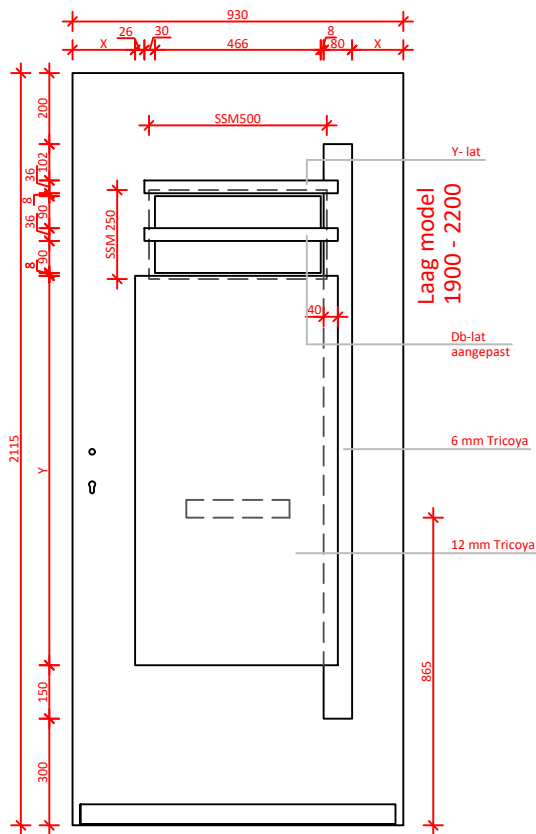

Strakke SponningMaat  
 Pasmaat deurbreedte t/m 1000 mm : SSM 500mm  
 Pasmaat deurbreedte 1001 t/m 1100 mm : SSM 600mm  
 Pasmaat deurbreedte > 1101 mm : SSM 700mm

DATUM:	GEWIJZIGD:	CALCULATIENR:	TEKENINGNR:	MODEL: 9503N	HOUTSOORT:
--------	------------	---------------	-------------	-----------------	------------

	KLANT/PROJECT: overzicht modellen 9503N met briefleuf			DCM NUMMER:
--	--	--	--	-------------

AANVRAAG:	SCHAAL:	GETEKEND: MN	LEVERWEEK:	1.2a P.51
-----------	---------	-----------------	------------	-----------

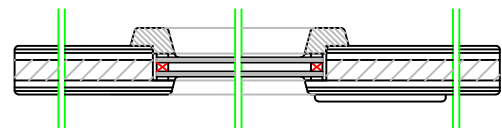
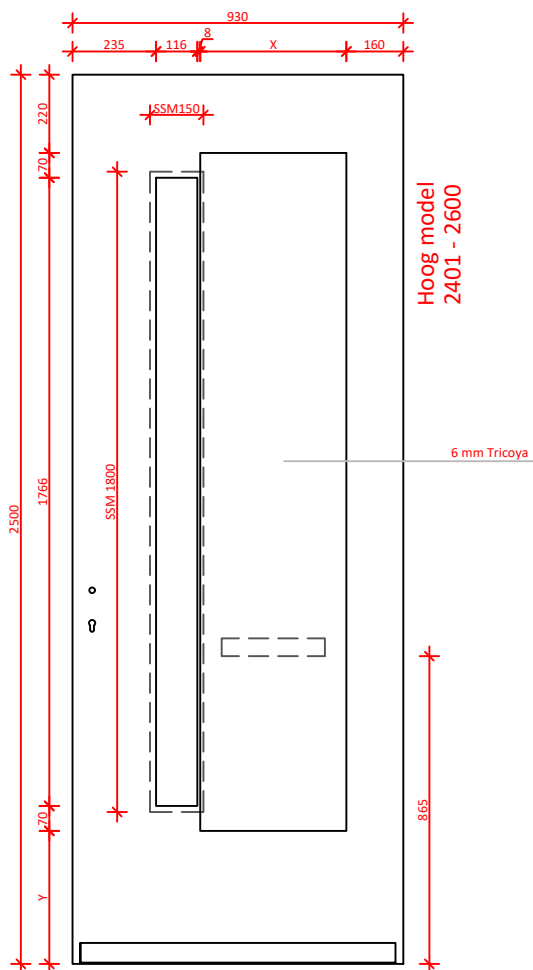
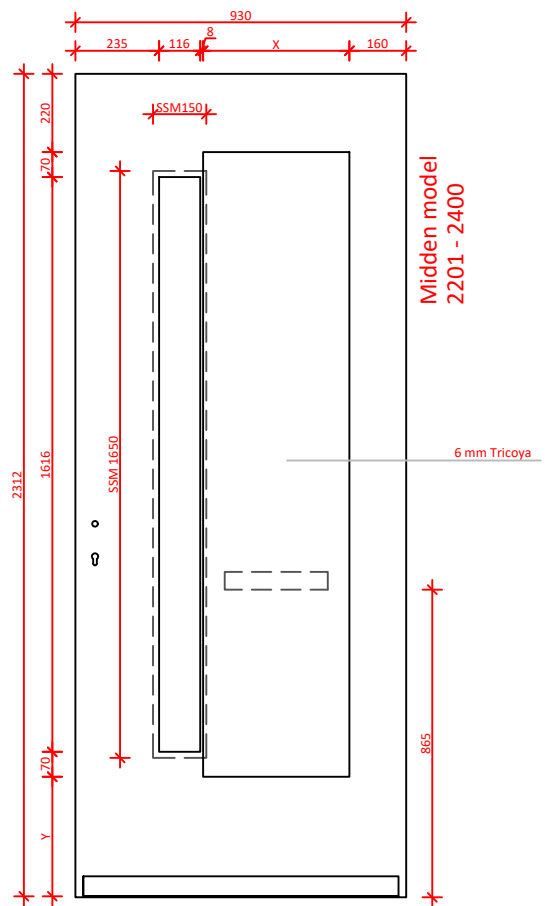
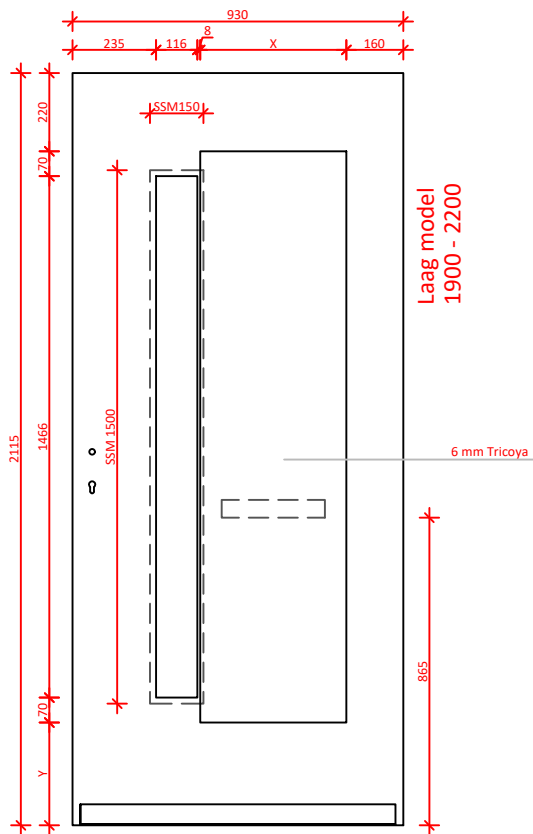

DATUM:	GEWIJZIGD:	CALCULATIENR:	TEKENINGNR:	MODEL: 9504N	HOUTSOORT:
--------	------------	---------------	-------------	-----------------	------------

	KLANT/PROJECT: overzicht modellen 9504N met briefleuf			DCM NUMMER:
--	--	--	--	-------------

AANVRAAG:	SCHAAL:	GETEKEND: MN	LEVERWEEK:	1.2a P.52
-----------	---------	-----------------	------------	-----------



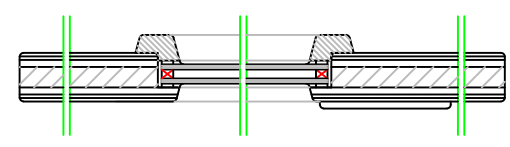
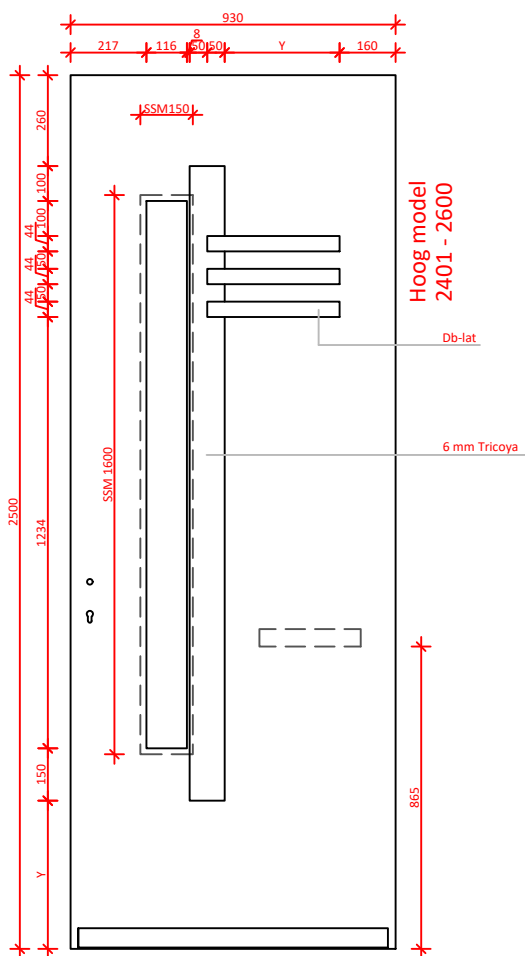
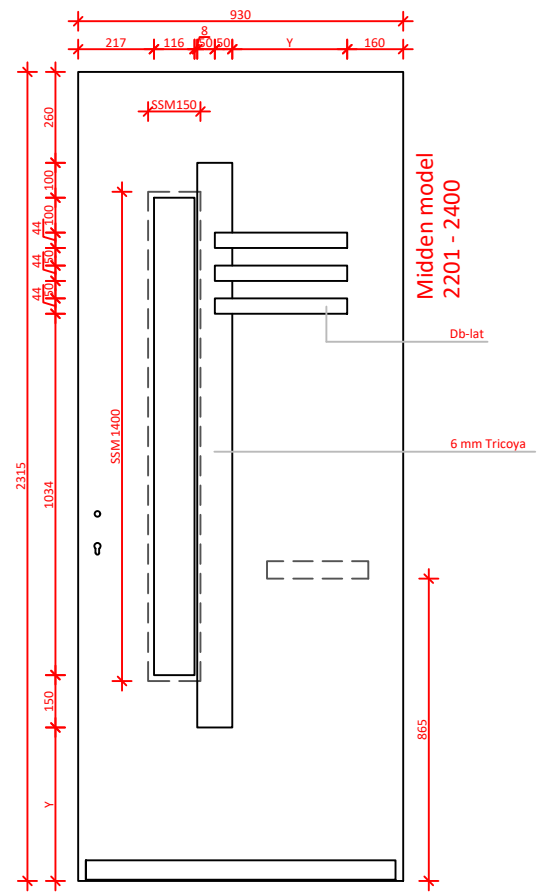
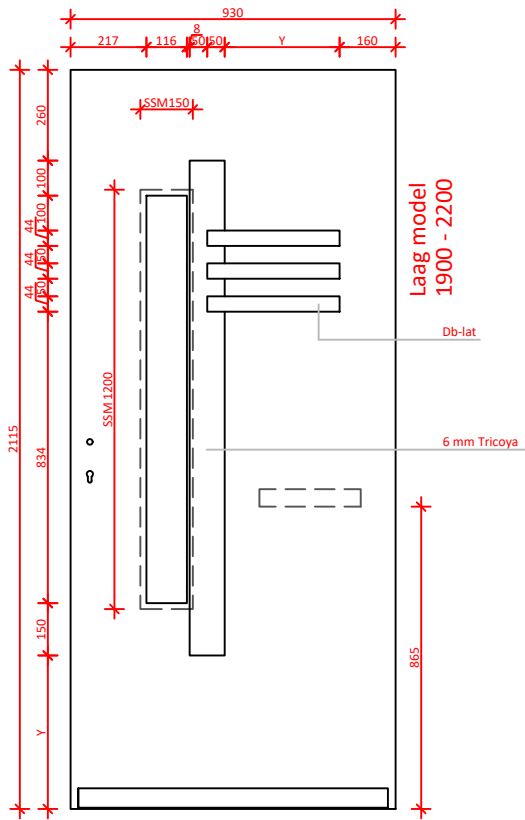

DATUM:	GEWIJZIGD:	CALCULATIENR:	TEKENINGNR:	MODEL: 9505N	HOUTSOORT:
--------	------------	---------------	-------------	-----------------	------------

	KLANT/PROJECT: overzicht modellen 9505N			DCM NUMMER:
--	--	--	--	-------------

AANVRAAG:	SCHAAL:	GETEKEND: MN	LEVERWEEK:	1.2a P.53
-----------	---------	-----------------	------------	-----------

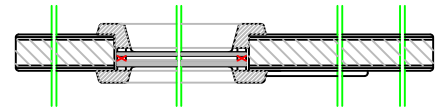
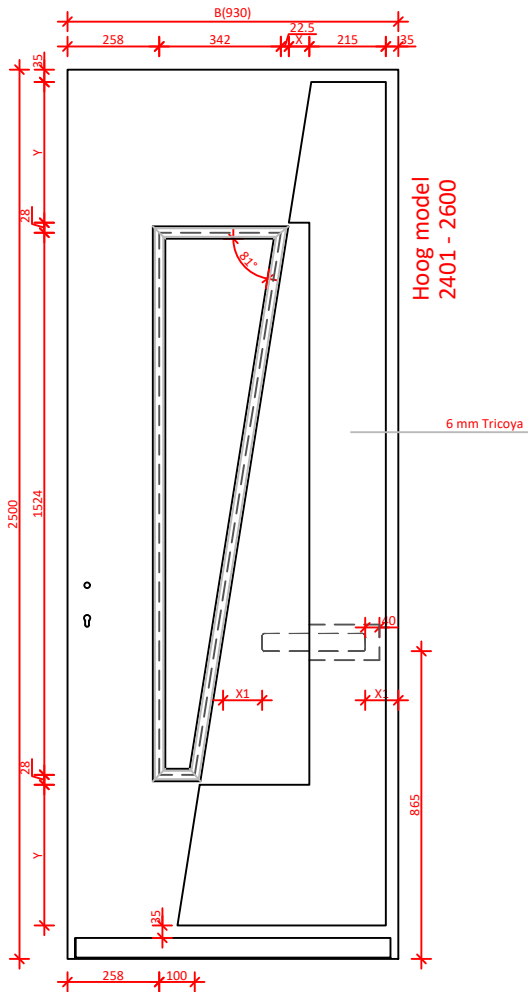
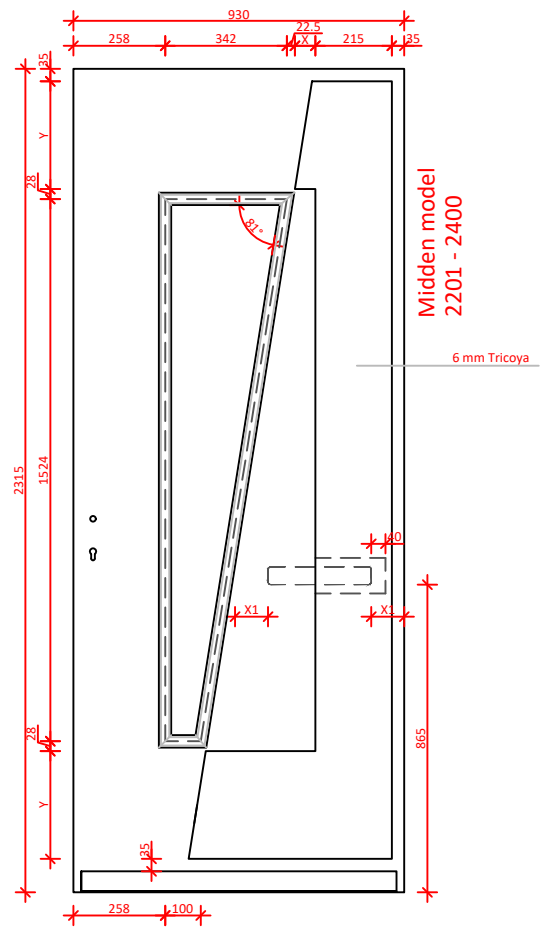
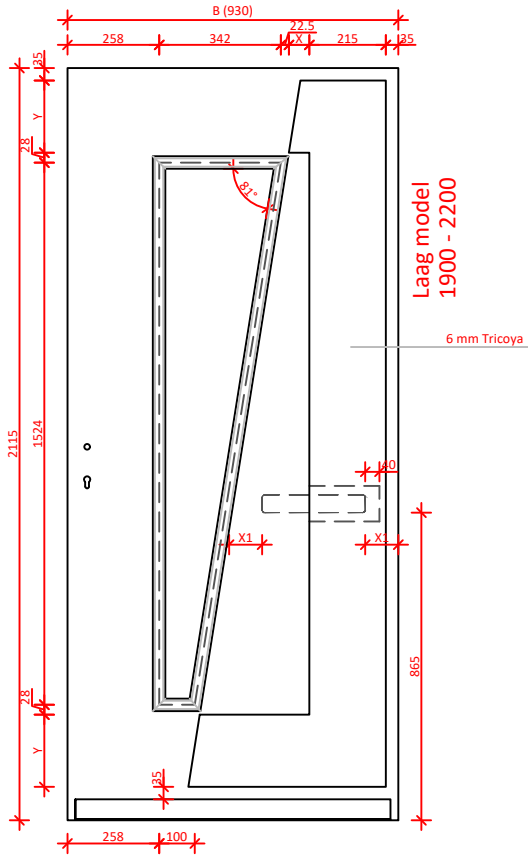

DATUM:	GEWIJZIGD: 21-04-2020	CALCULATIENR:	TEKENINGNR: 9536N	MODEL: 9536N	HOUTSOORT:
KLANT/PROJECT: overzicht modellen 9536N L1 - R4					DCM NUMMER:
		AANVRAAG:	SCHAAL:	GETEKEND: MN	LEVERWEEK: 1.2a P.54

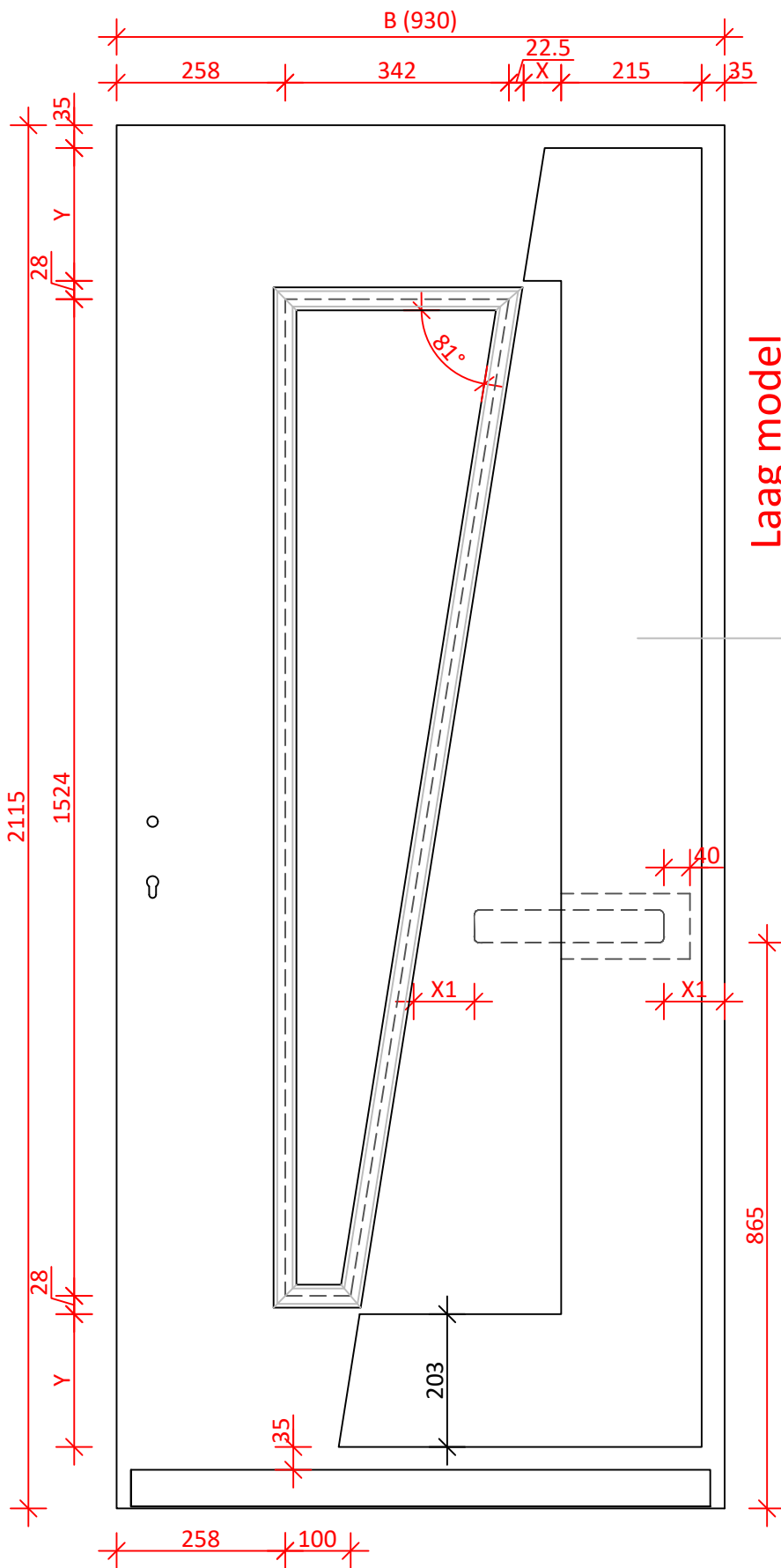

DATUM:	GEWIJZIGD: 21-04-2020	CALCULATIENR:	TEKENINGNR: 9536N	MODEL: 9536N	HOUTSOORT:
			KLANT/PROJECT: 9536N Laag model L1 -R4		DCM NUMMER:
			AANVRAAG:	SCHAAL:	GETEKEND: MN

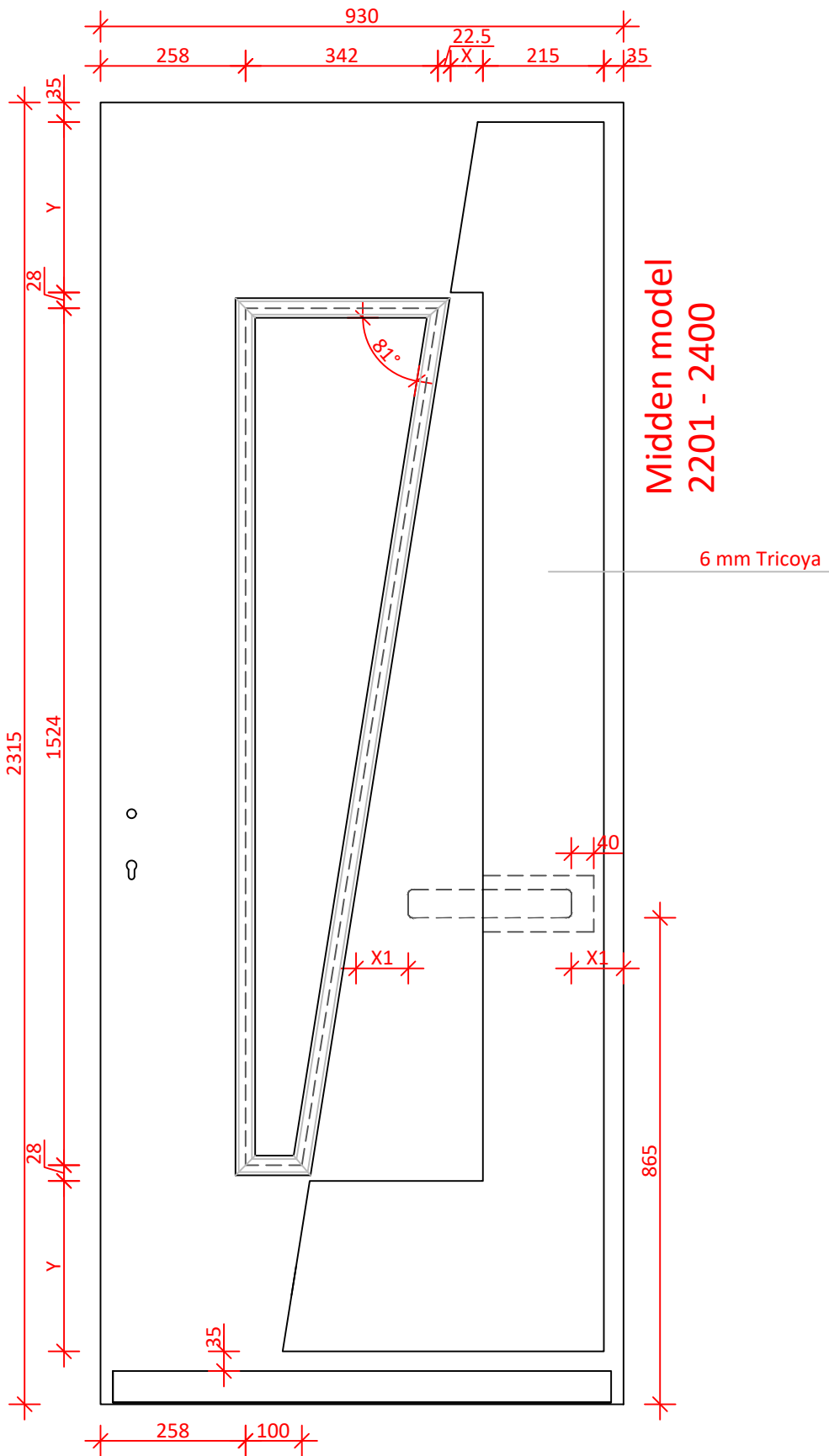

DATUM:	GEWIJZIGD: 21-04-2020	CALCULATIENR:	TEKENINGNR: 9536N	MODEL: 9536N	HOUTSOORT:
			KLANT/PROJECT: 9536N Midden model L1 - R4		DCM NUMMER:
			AANVRAAG:	SCHAAL:	GETEKEND: MN

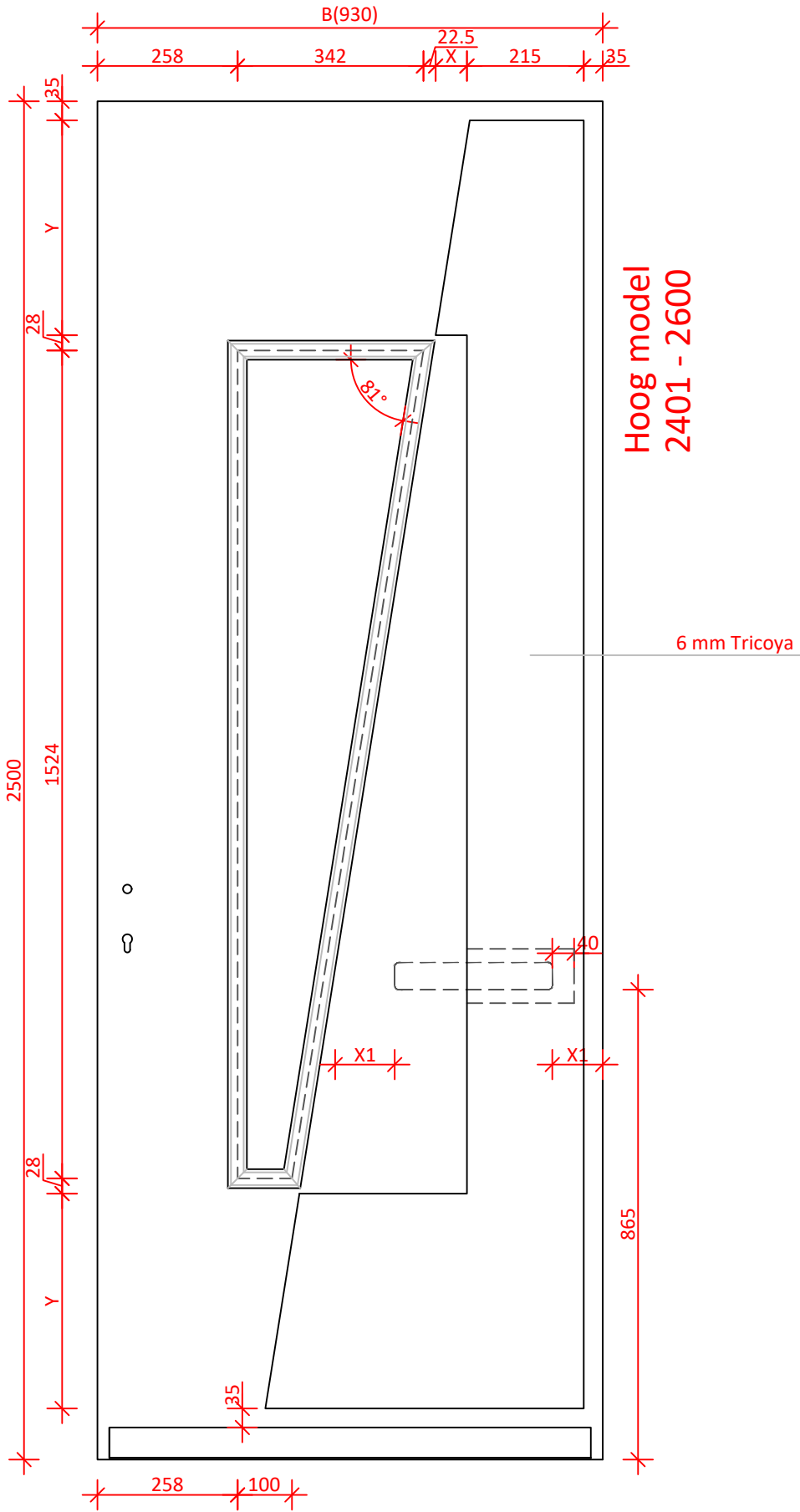

DATUM:	GEWIJZIGD: 21-04-2020	CALCULATIENR:	TEKENINGNR: 9536N	MODEL: 9536N	HOUTSOORT:
			KLANT/PROJECT: 9536N Hoog model L1 - R4		DCM NUMMER:
			AANVRAAG:	SCHAAL:	GETEKEND: MN

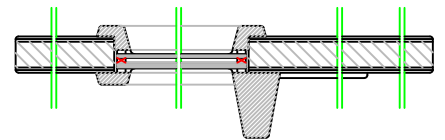
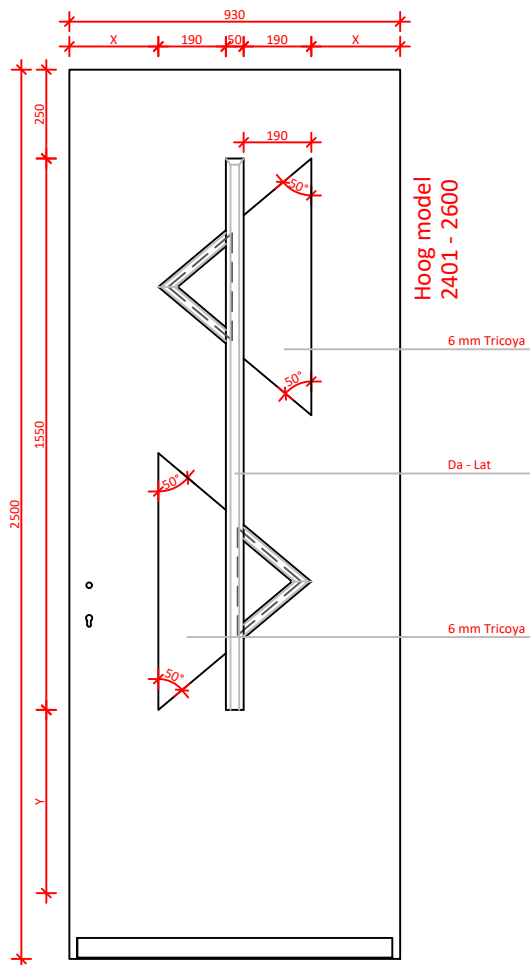
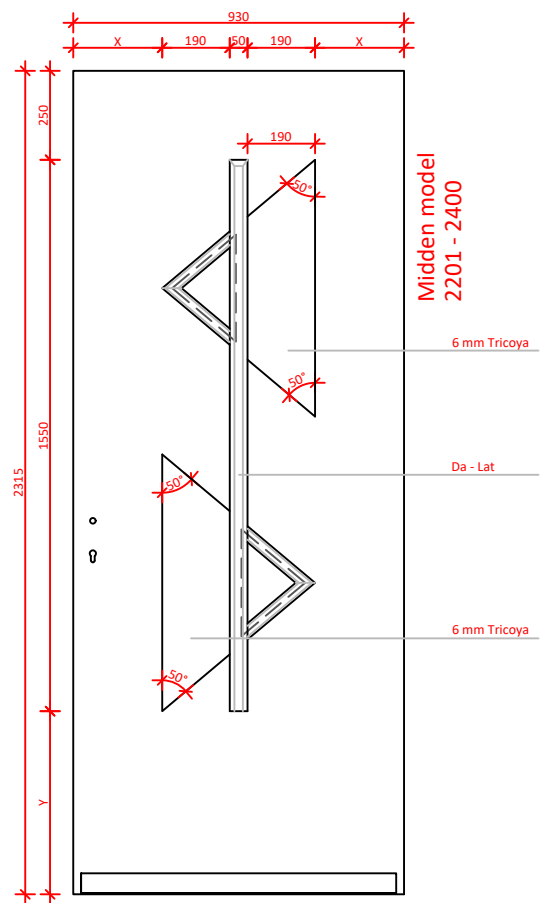
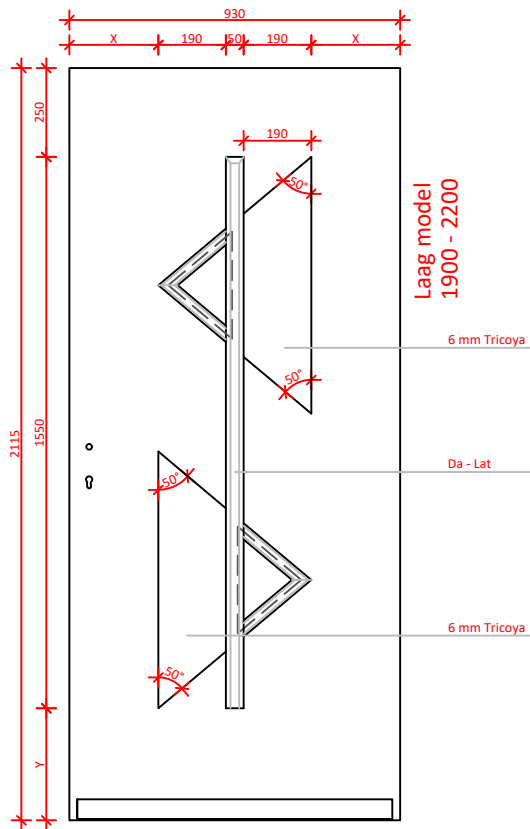

DATUM:	GEWIJZIGD:	CALCULATIENR:	TEKENINGNR:	MODEL: 9538	HOUTSOORT:
--------	------------	---------------	-------------	----------------	------------

	KLANT/PROJECT: overzicht modellen 9538 L1 - R4			DCM NUMMER:
--	---	--	--	-------------

AANVRAAG:	SCHAAL:	GETEKEND: MN	LEVERWEEK:	1.2a P.58
-----------	---------	-----------------	------------	-----------

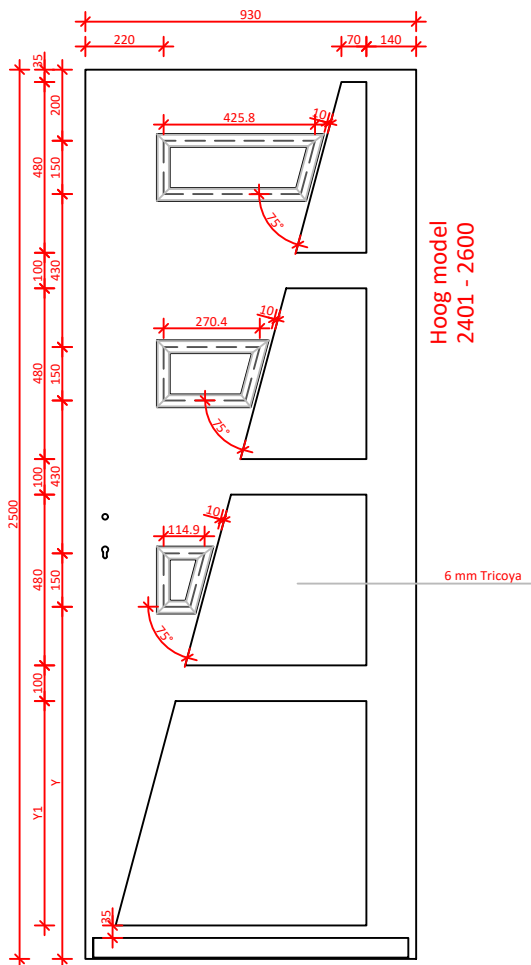
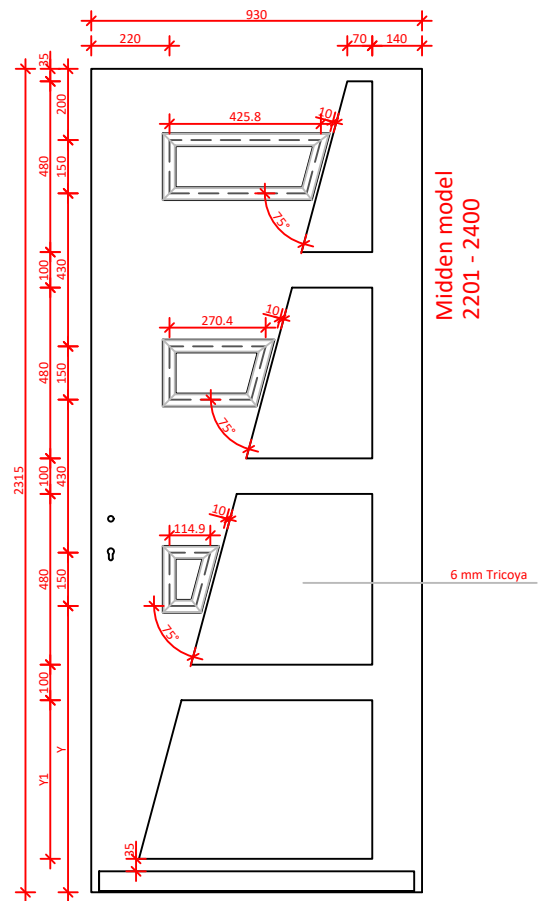
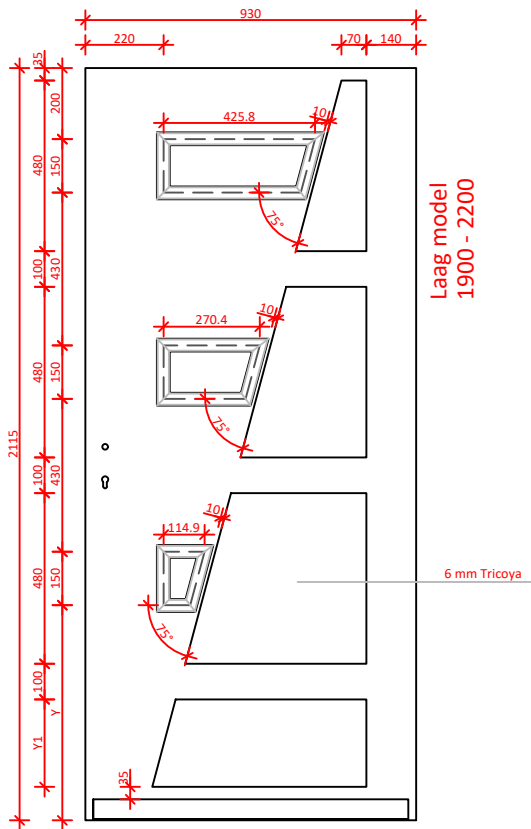

DATUM:	GEWIJZIGD:	CALCULATIENR:	TEKENINGNR:	MODEL: 9548N	HOUTSOORT:
--------	------------	---------------	-------------	-----------------	------------

KLANT/PROJECT: overzicht modellen 9548N L1 - R4				DCM NUMMER:	
--	--	--	--	-------------	--

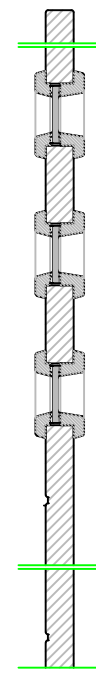
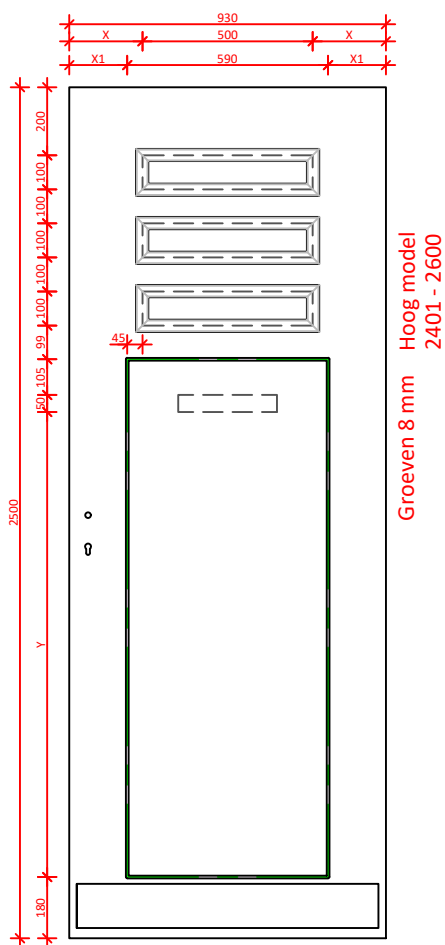
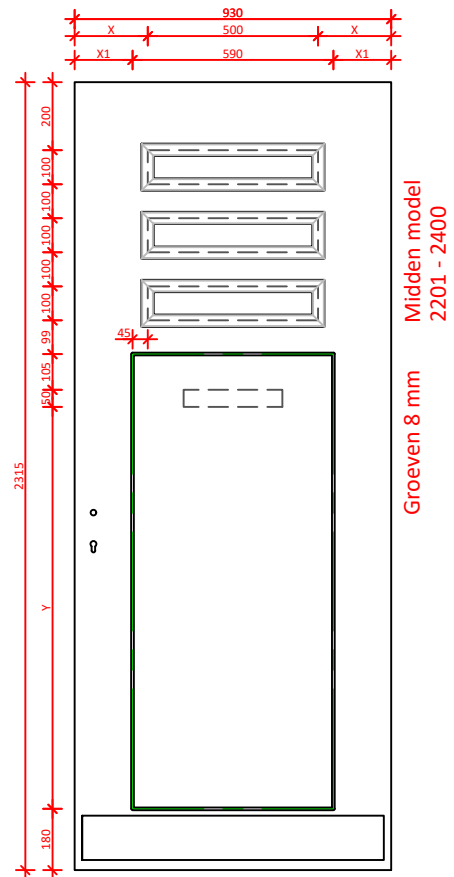
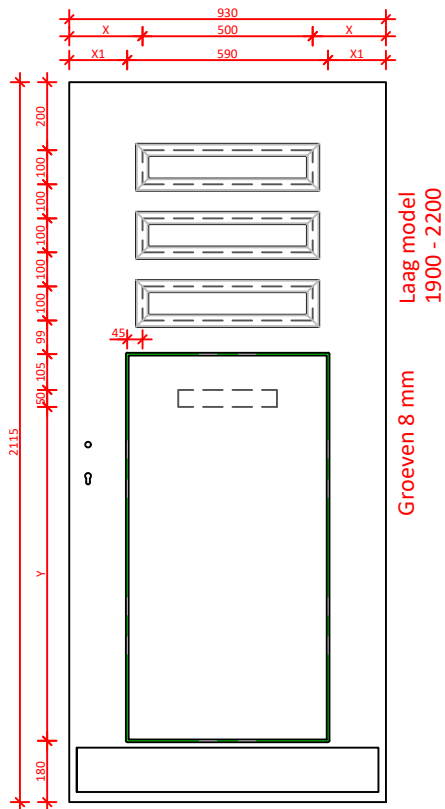

DATUM:	GEWIJZIGD:	CALCULATIENR:	TEKENINGNR: 9578N	MODEL: 9578N	HOUTSOORT:
--------	------------	---------------	----------------------	-----------------	------------



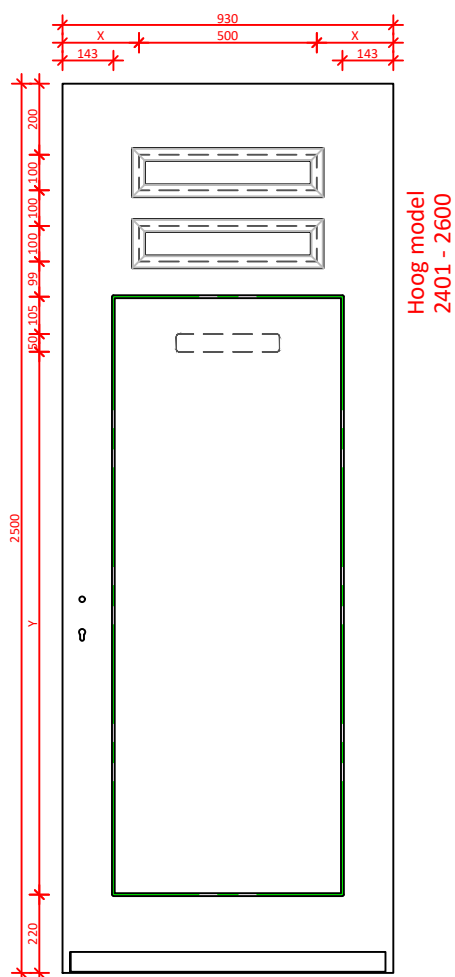
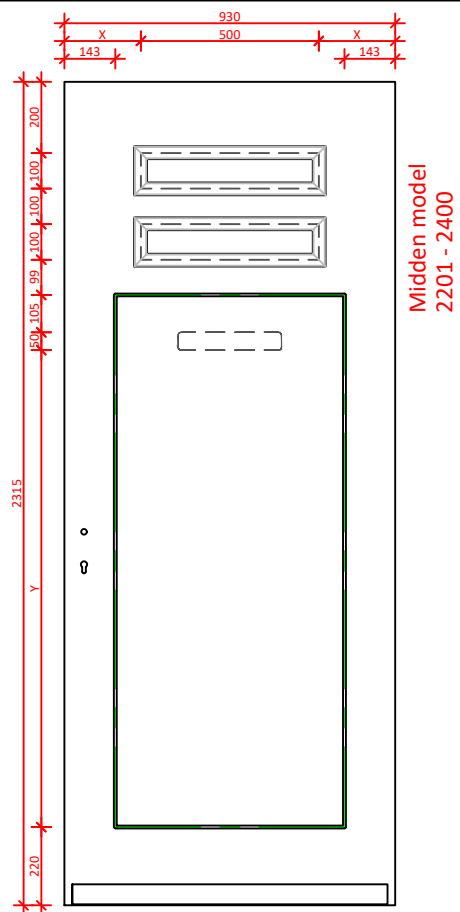
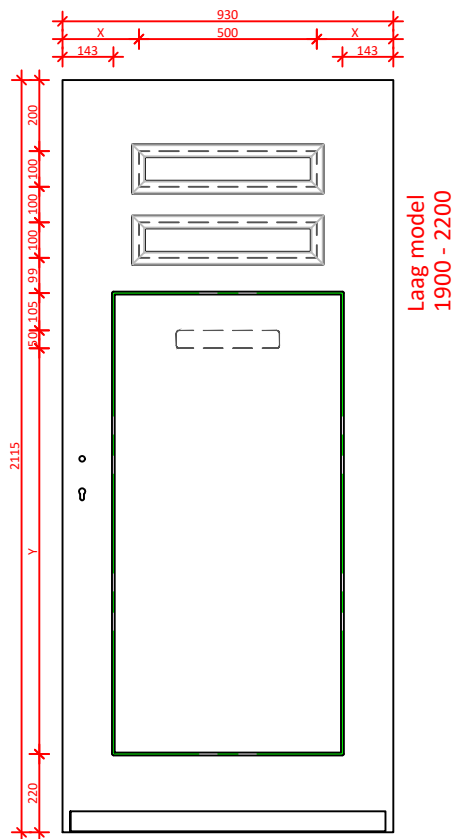

**Strakke SponningMaat**

- Pasmaat deurbreedte t/m 1000 mm : SSM 500mm
- Pasmaat deurbreedte 1001 t/m 1100 mm : SSM 600mm
- Pasmaat deurbreedte > 1101 mm : SSM 700mm

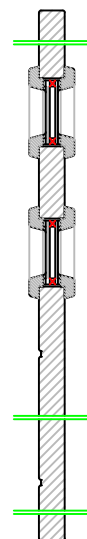

DATUM:	GEWIJZIGD:	CALCULATIENR:	TEKENINGNR: 9579N	MODEL: 9579N	HOUTSOORT:
--------	------------	---------------	----------------------	-----------------	------------

<b>KEGRO   DEUREN</b>	KLANT/PROJECT: overzicht modellen 9579N			DCM NUMMER:
-----------------------	--	--	--	-------------

AANVRAAG:	SCHAAL:	GETEKEND: MN	LEVERWEEK:	1.2a P.61
-----------	---------	-----------------	------------	-----------

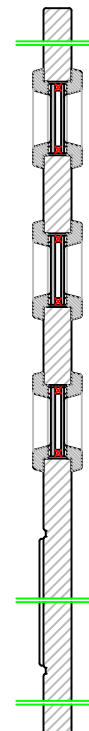
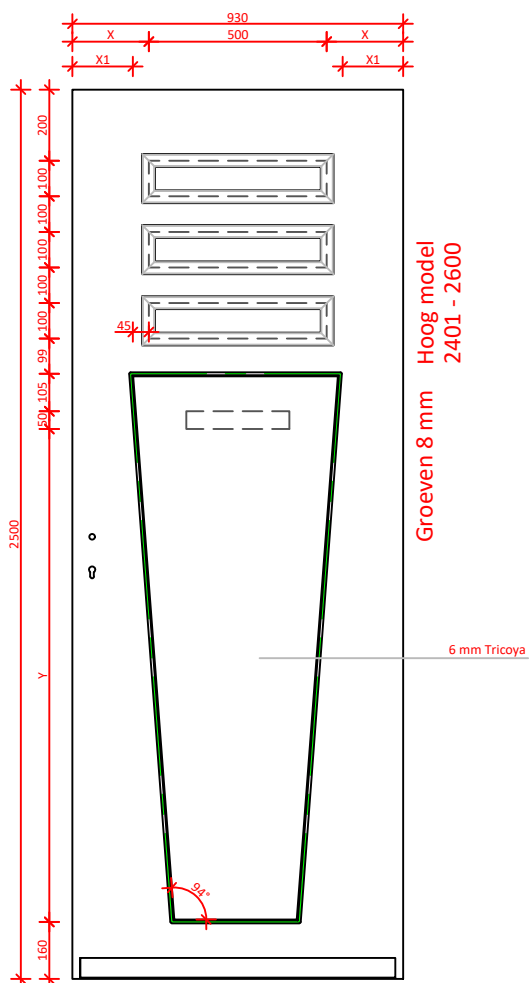
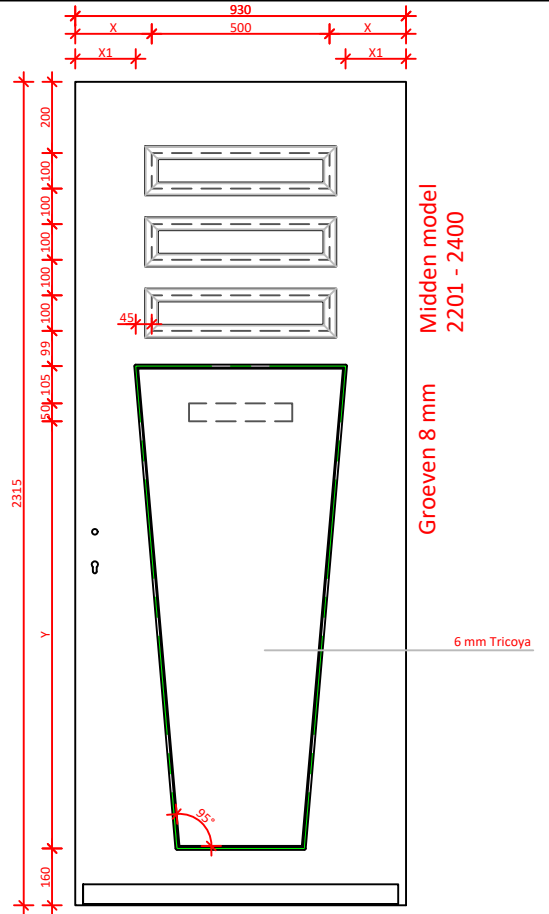
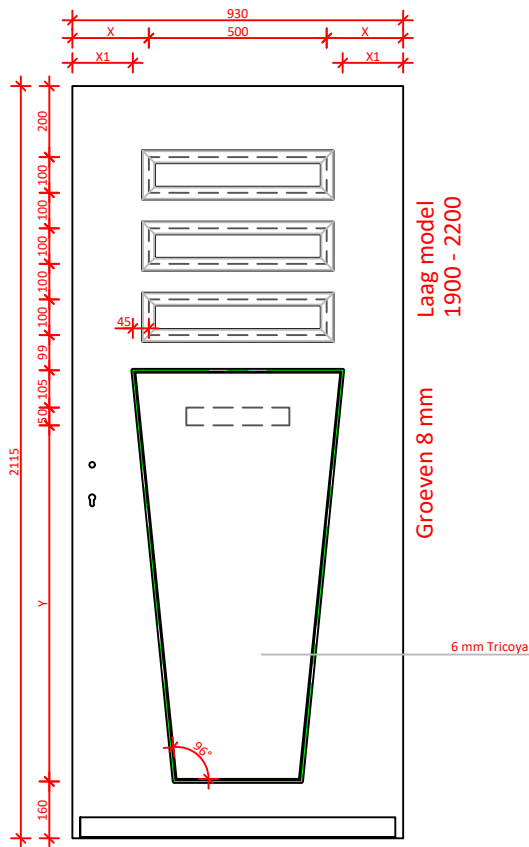

**Strakke SponningMaat**

- Pasmaat deurbreedte t/m 1000 mm : SSM 500mm
- Pasmaat deurbreedte 1001 t/m 1100 mm : SSM 600mm
- Pasmaat deurbreedte > 1101 mm : SSM 700mm

DATUM:	GEWIJZIGD:	CALCULATIENR:	TEKENINGNR:	MODEL: 9580N	HOUTSOORT:
--------	------------	---------------	-------------	-----------------	------------

<b>KEGRO   DEUREN</b>	KLANT/PROJECT: overzicht modellen 9580N			DCM NUMMER:
-----------------------	--	--	--	-------------

AANVRAAG:	SCHAAL:	GETEKEND: MN	LEVERWEEK:	1.2a P.62
-----------	---------	-----------------	------------	-----------

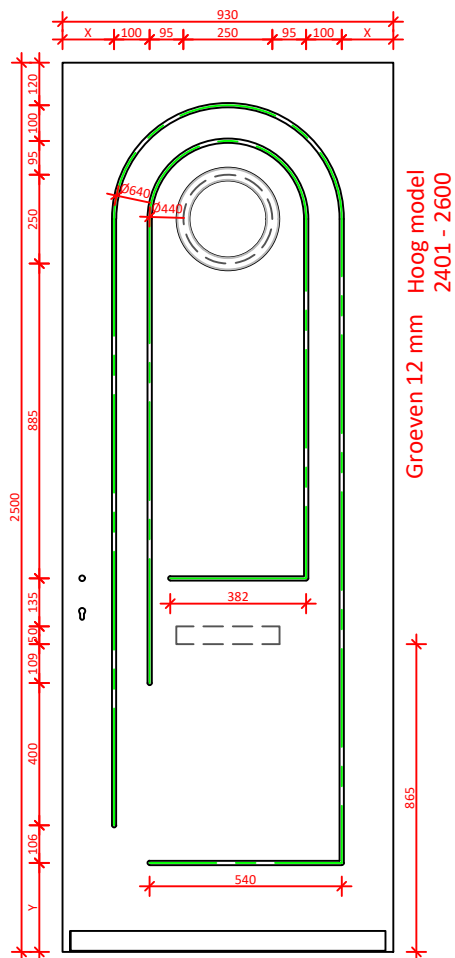
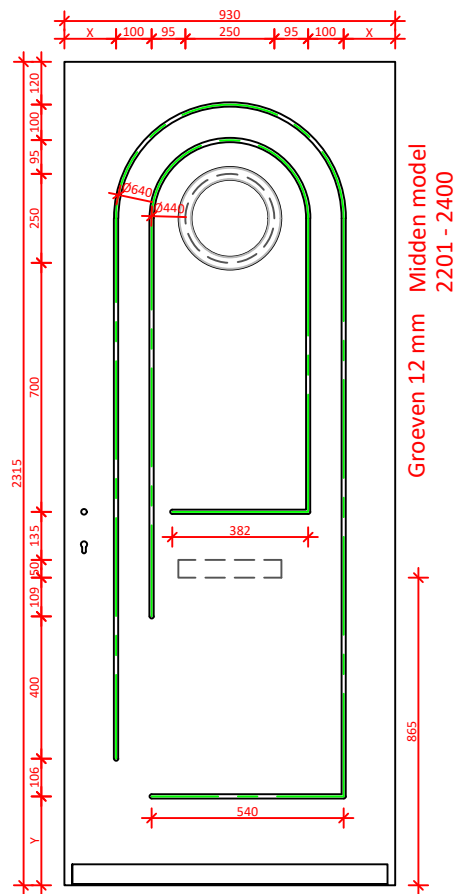
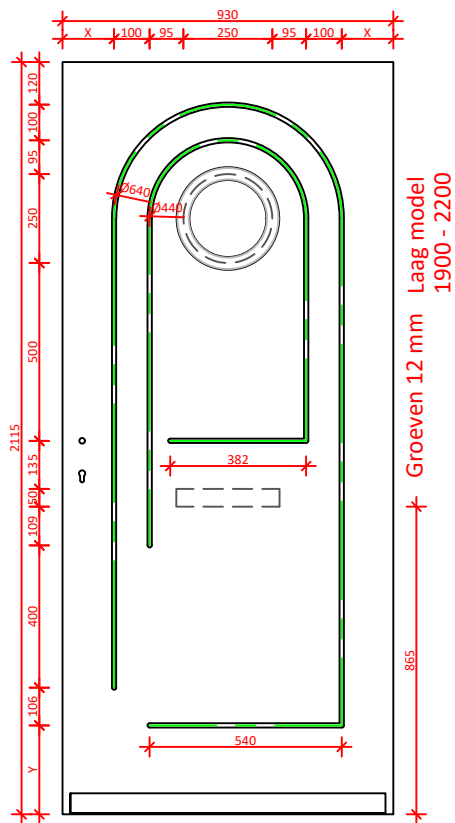

DATUM:	GEWIJZIGD:	CALCULATIENR:	TEKENINGNR:	MODEL: 9726	HOUTSOORT:
--------	------------	---------------	-------------	----------------	------------

	KLANT/PROJECT: overzicht modellen 9726 L1 - R4			DCM NUMMER:
--	---	--	--	-------------

AANVRAAG:	SCHAAL:	GETEKEND: MN	LEVERWEEK: 1.2a P.63
-----------	---------	-----------------	-------------------------

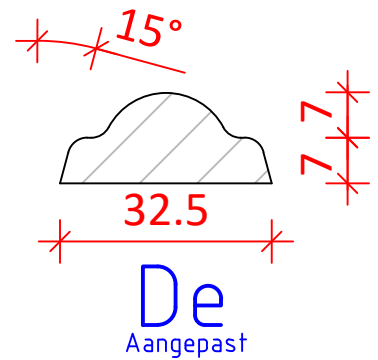
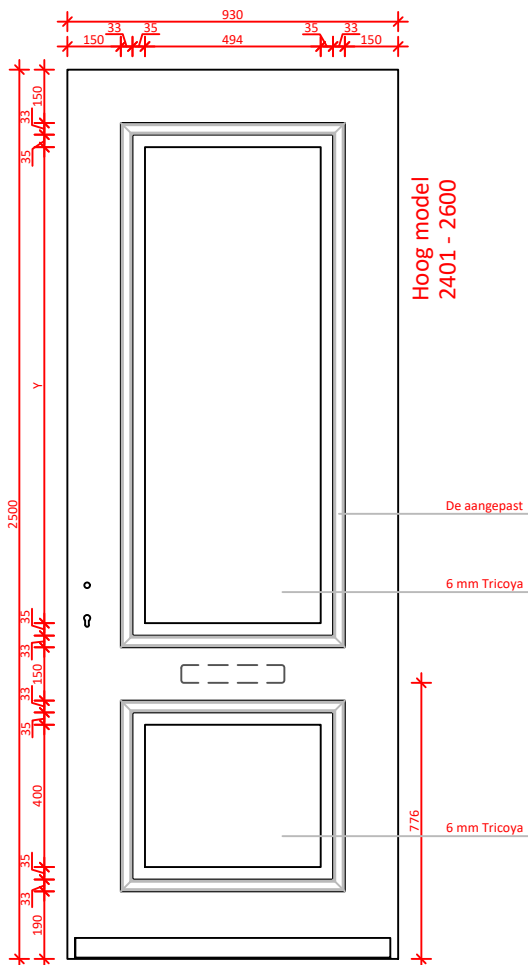
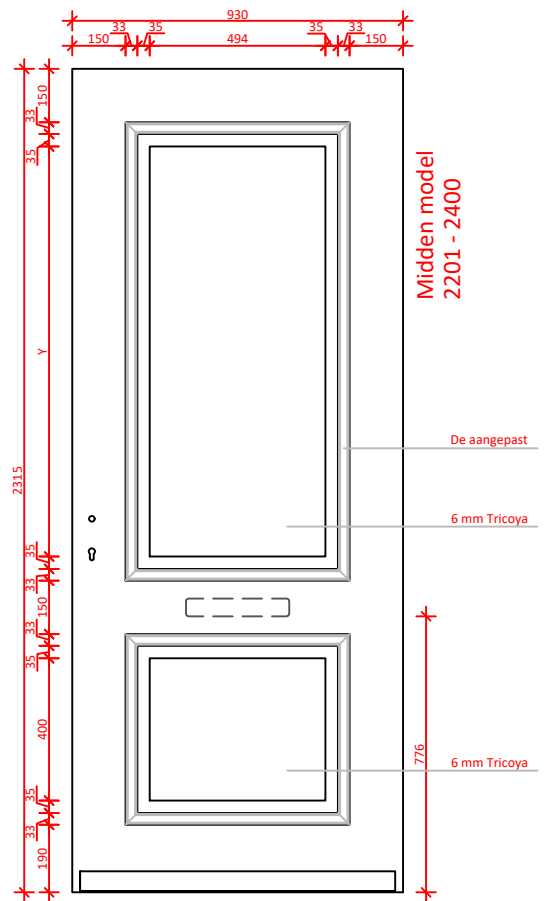
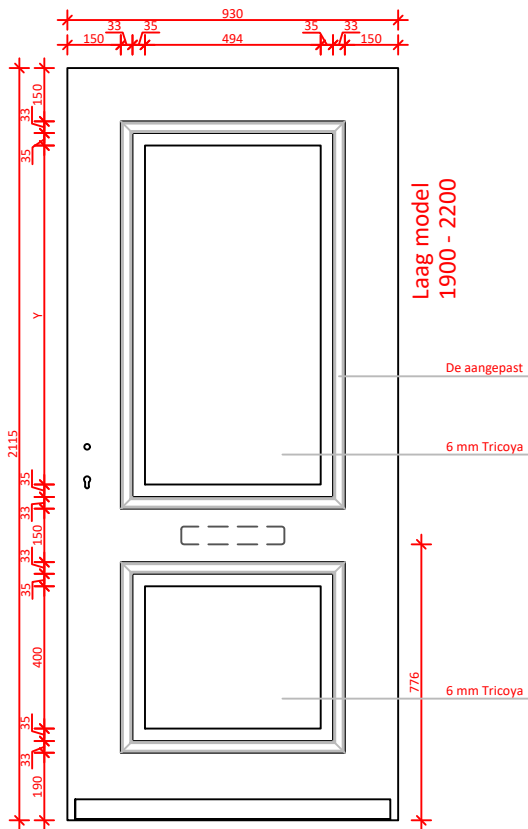

DATUM:	GEWIJZIGD:	CALCULATIENR:	TEKENINGNR:	MODEL: 9750	HOUTSOORT:
--------	------------	---------------	-------------	----------------	------------

	KLANT/PROJECT: overzicht modellen 9750			DCM NUMMER:
--	---	--	--	-------------

AANVRAAG:	SCHAAL:	GETEKEND: MN	LEVERWEEK: 1.2a P.64
-----------	---------	-----------------	-------------------------

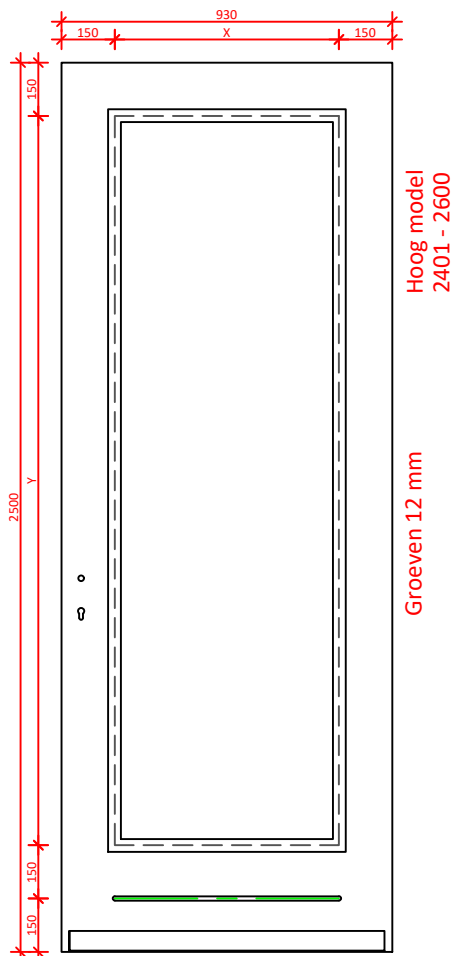
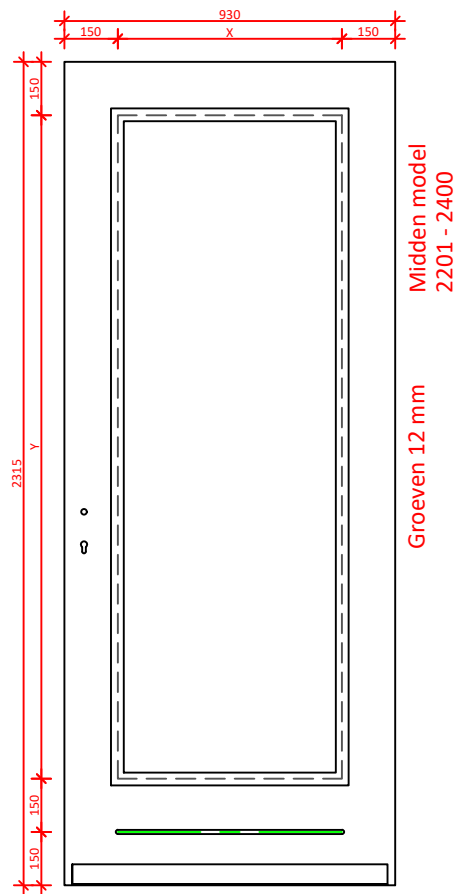
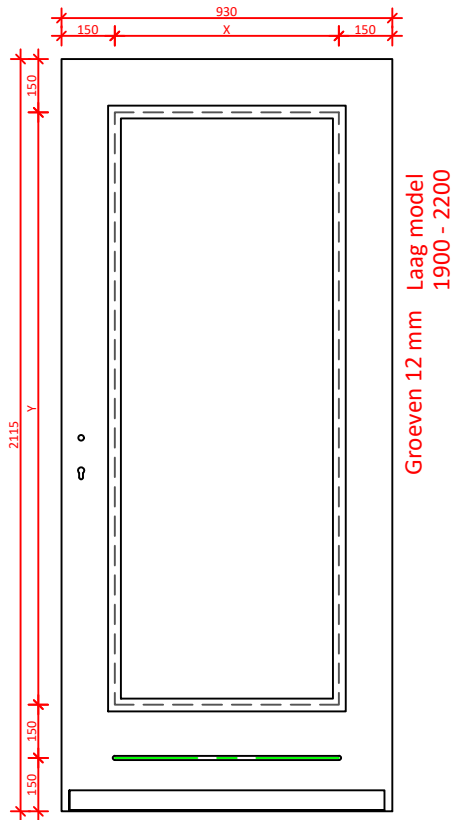

Alleen in KegaPro+ 74 mm.

DATUM:	GEWIJZIGD:	CALCULATIENR:	TEKENINGNR: 9768	MODEL: 9768	HOUTSOORT:
--------	------------	---------------	---------------------	----------------	------------

	KLANT/PROJECT: overzicht modellen 9768 L1 - R4			DCM NUMMER:
--	---	--	--	-------------

AANVRAAG:	SCHAAL:	GETEKEND:	LEVERWEEK:	1.2a P.65
-----------	---------	-----------	------------	-----------

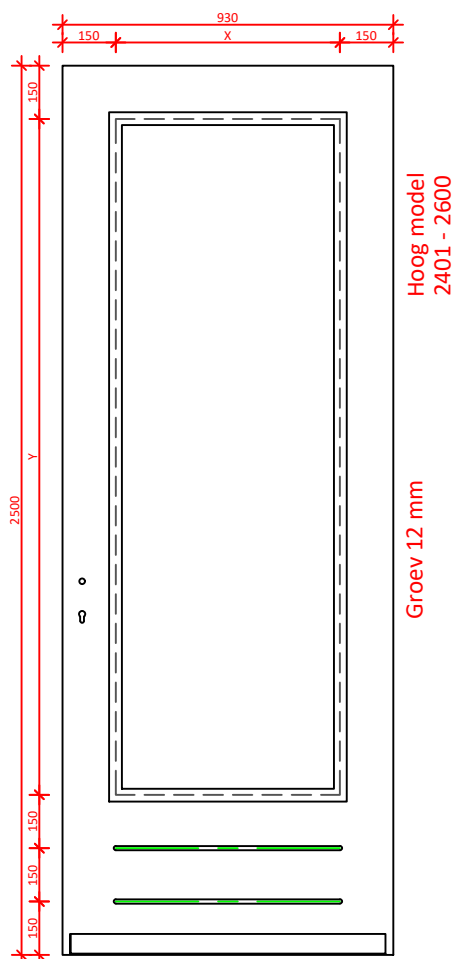
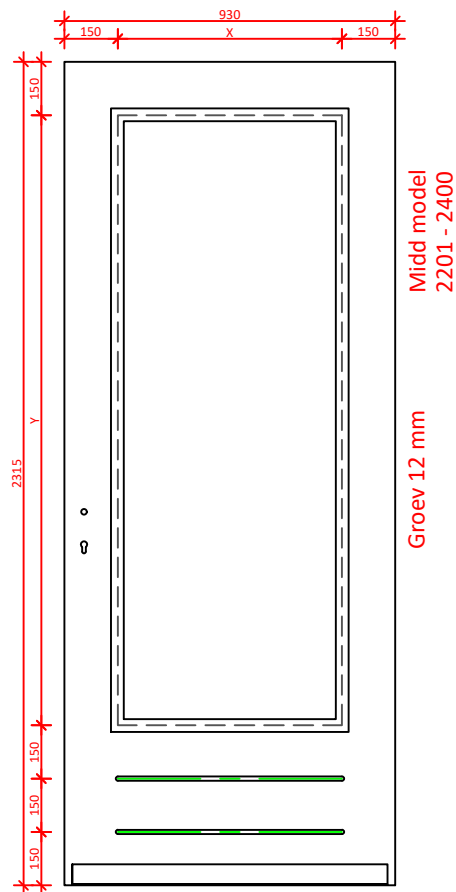
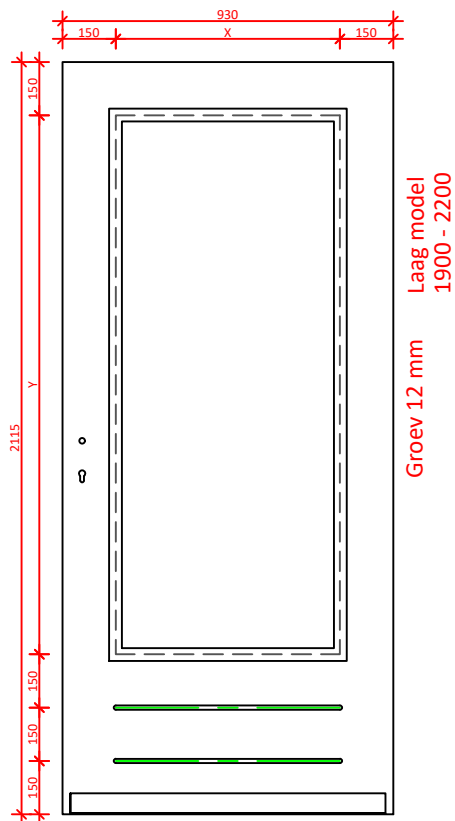

Alleen in KegaPro 74 mm .

DATUM:	GEWIJZIGD:	CALCULATIENR:	TEKENINGNR: 9769	MODEL: 9769	HOUTSOORT:
--------	------------	---------------	---------------------	----------------	------------

	KLANT/PROJECT: overzicht modell 9769 L1 - R4			DCM NUMMER:
--	---	--	--	-------------

AANVRAAG:	SCHAAL:	GETEKEND:	LEVERWEEK:	1.2a P.66
-----------	---------	-----------	------------	-----------

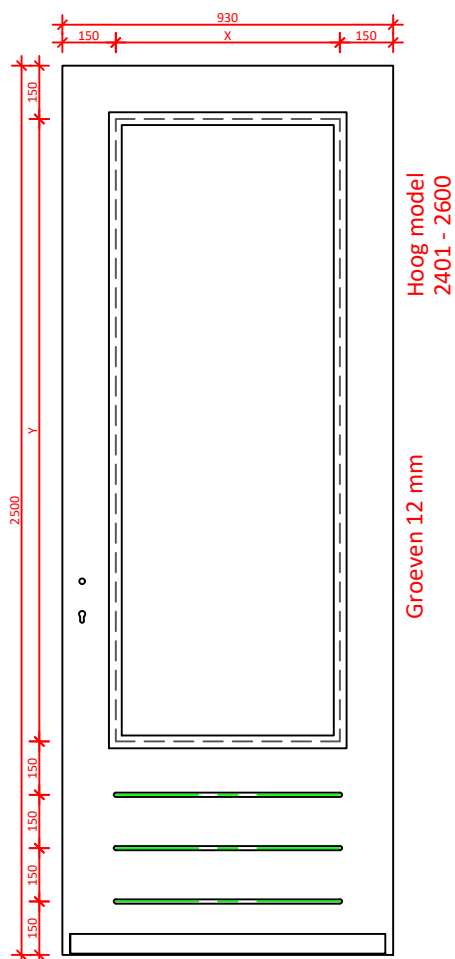
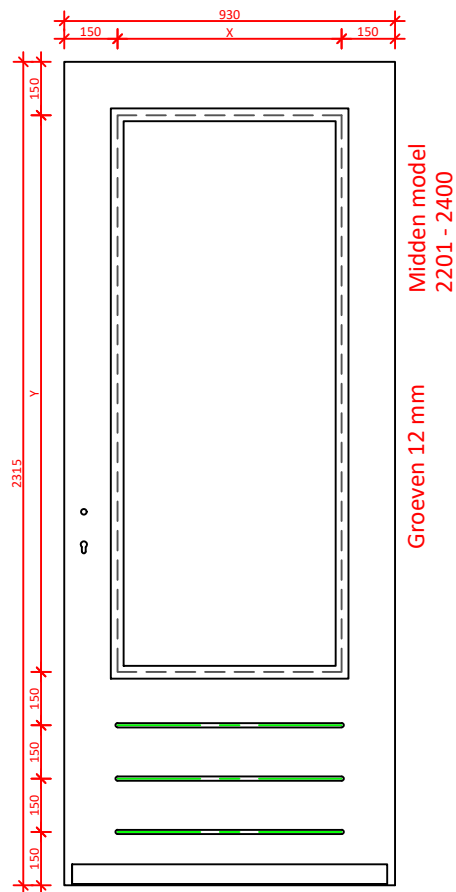
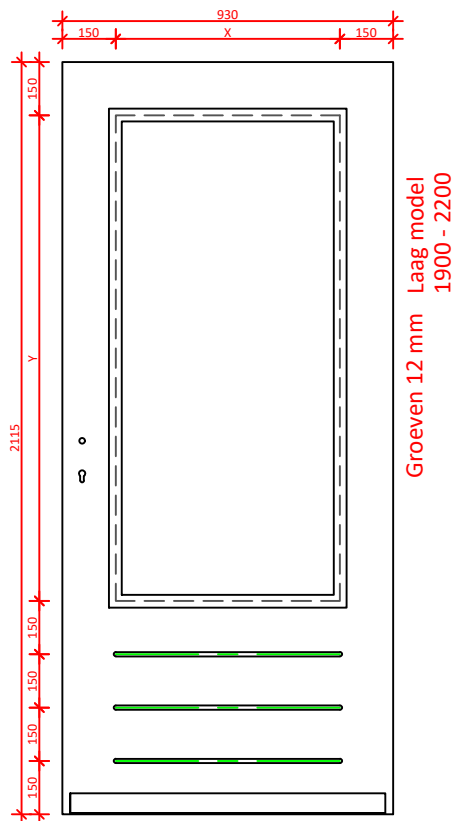

Alleen in KegaPro 74 mm.

DATUM:	GEWIJZIGD:	CALCULATIENR:	TEKENINGNR: 9770	MODEL: 9770	HOUTSOORT:
--------	------------	---------------	---------------------	----------------	------------

	KLANT/PROJECT: overzicht modellen 9770 L1 - R4			DCM NUMMER:
--	---	--	--	-------------

AANVRAAG:	SCHAAL:	GETEKEND:	LEVERWEEK:	1.2a P.67
-----------	---------	-----------	------------	-----------

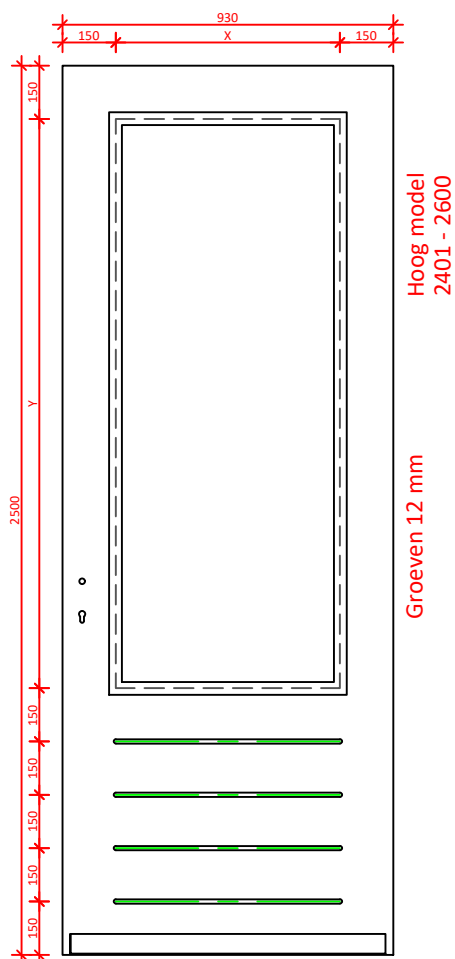
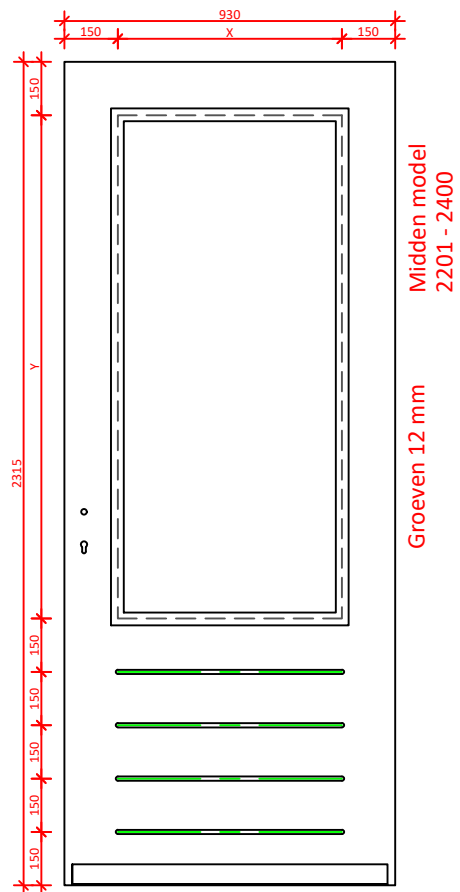
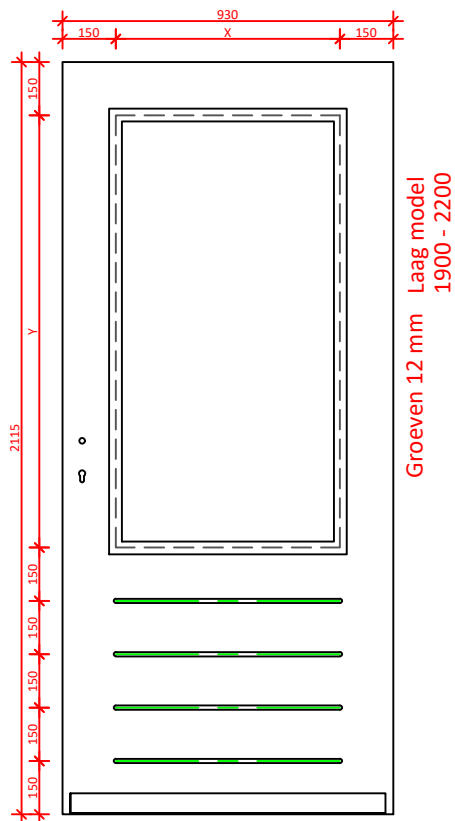

Alleen in KegaPro+ 74 mm.

DATUM:	GEWIJZIGD:	CALCULATIENR:	TEKENINGNR: 9771	MODEL: 9771	HOUTSOORT:
--------	------------	---------------	---------------------	----------------	------------

	KLANT/PROJECT: overzicht modellen 9771 L1 - R4			DCM NUMMER:
--	---	--	--	-------------

AANVRAAG:	SCHAAL:	GETEKEND:	LEVERWEEK:	1.2a P.68
-----------	---------	-----------	------------	-----------



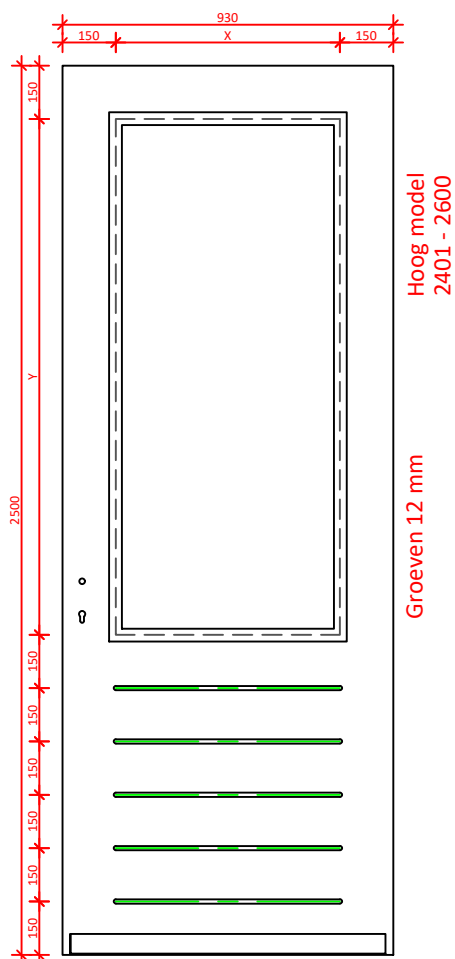
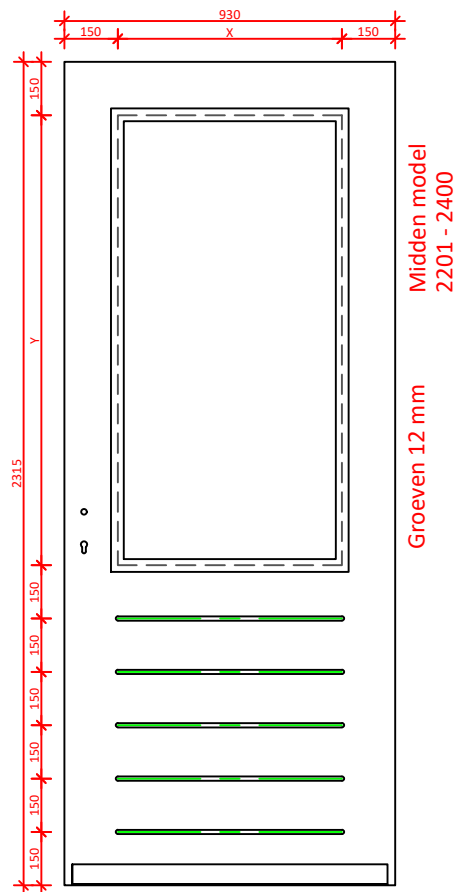
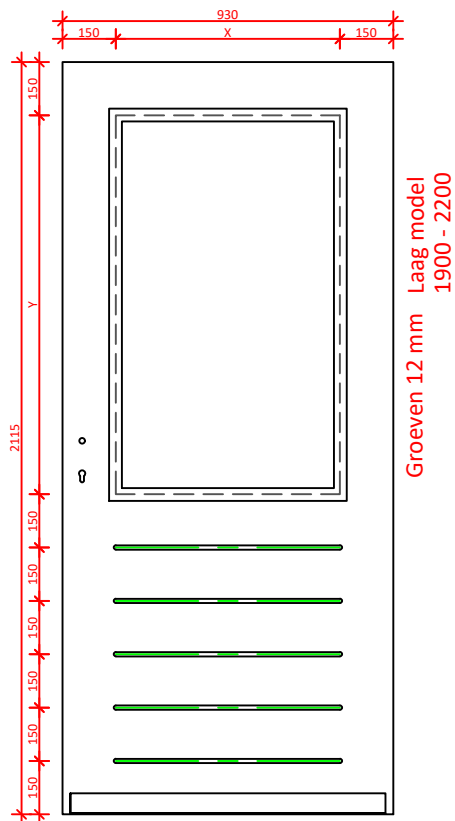

Alleen in KegaPro+ 74 mm.

DATUM:	GEWIJZIGD:	CALCULATIENR:	TEKENINGNR: 9772	MODEL: 9772	HOUTSOORT:
--------	------------	---------------	---------------------	----------------	------------

	KLANT/PROJECT: overzicht modellen 9772 L1 - R4			DCM NUMMER:
--	---	--	--	-------------

AANVRAAG:	SCHAAL:	GETEKEND:	LEVERWEEK:	1.2a P.69
-----------	---------	-----------	------------	-----------

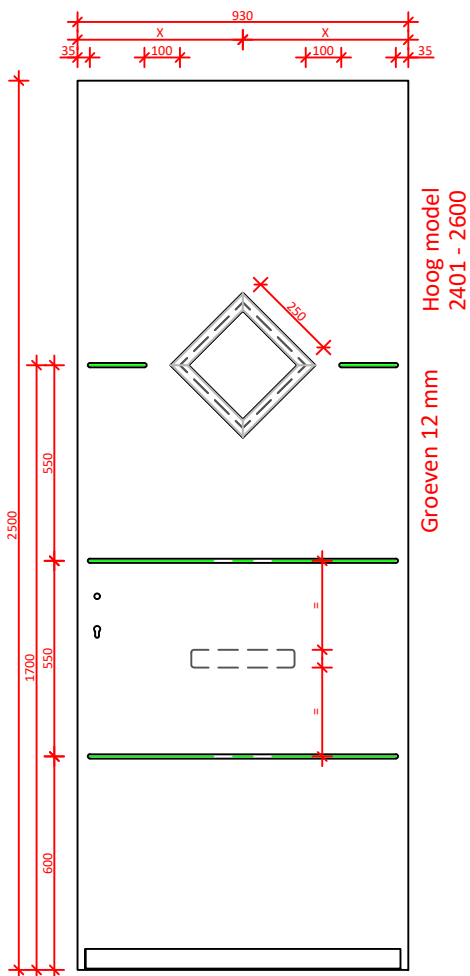
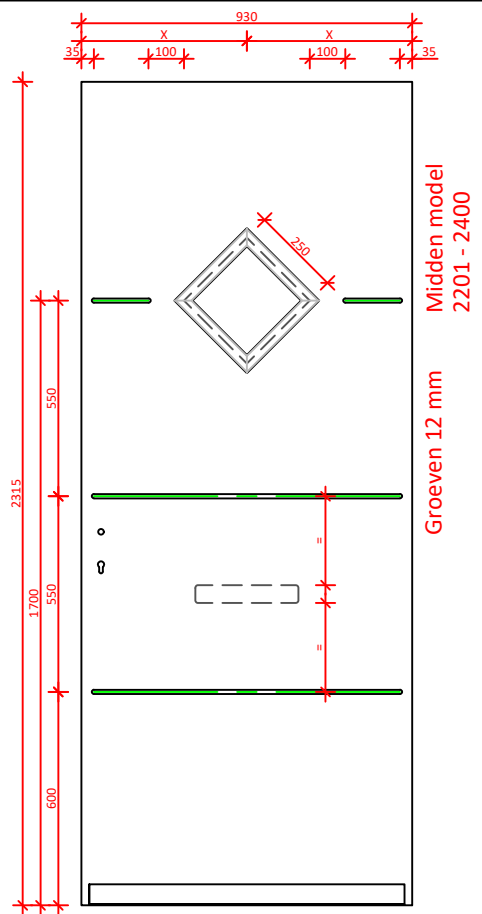
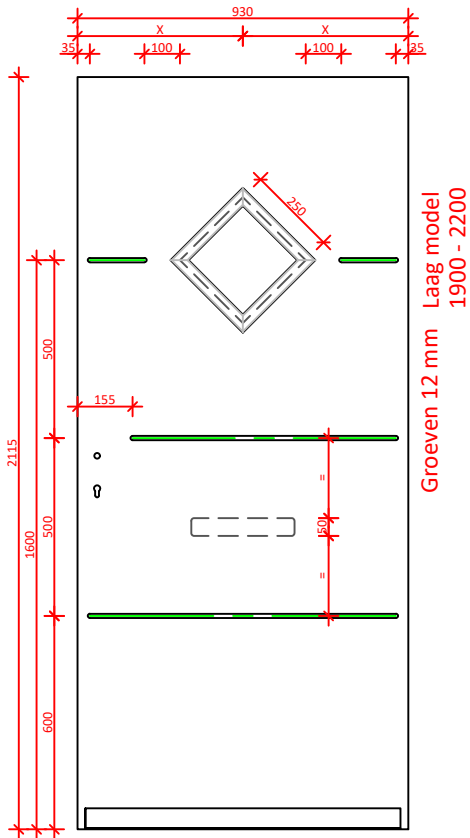

DATUM:	GEWIJZIGD:	CALCULATIENR:	TEKENINGNR:	MODEL: 9801N	HOUTSOORT:
--------	------------	---------------	-------------	-----------------	------------

	KLANT/PROJECT: overzicht modellen 9801N met briefsleuf			DCM NUMMER:
--	---	--	--	-------------

AANVRAAG:	SCHAAL:	GETEKEND: MN	LEVERWEEK: 1.2a P.70
-----------	---------	-----------------	-------------------------

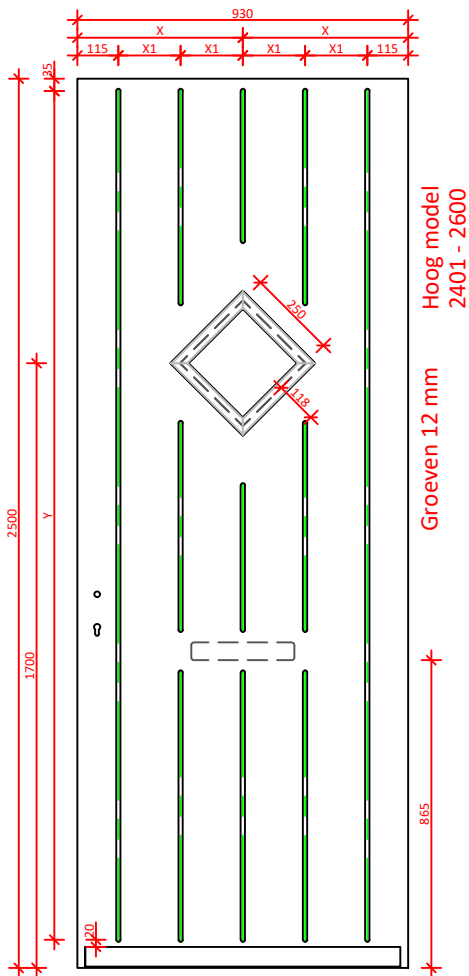
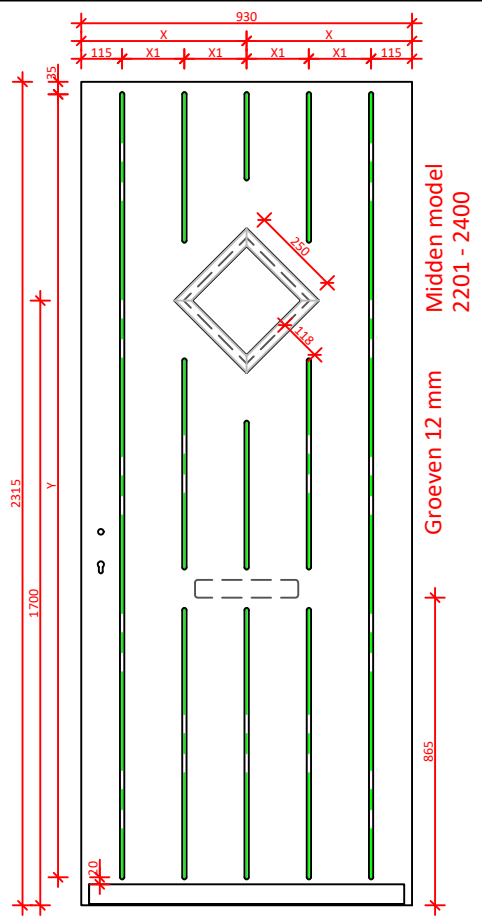
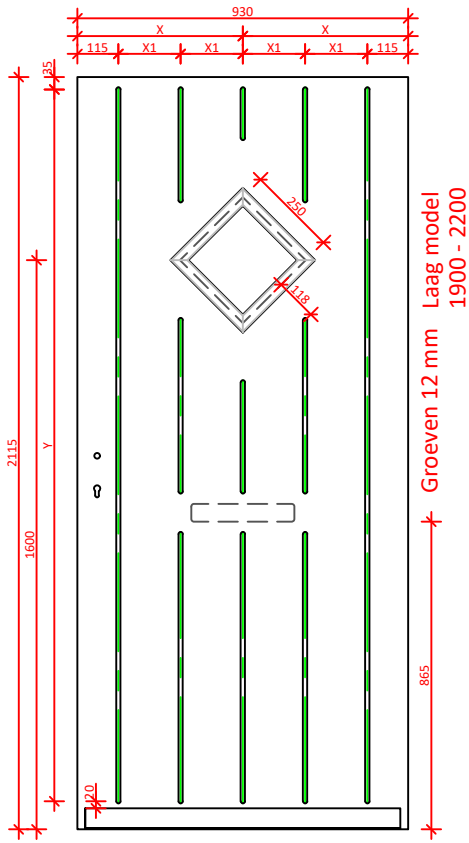

DATUM:	GEWIJZIGD:	CALCULATIENR:	TEKENINGNR:	MODEL: 9802N	HOUTSOORT:
--------	------------	---------------	-------------	-----------------	------------

	KLANT/PROJECT: overzicht modellen 9802N met briefsleuf			DCM NUMMER:
--	---	--	--	-------------

AANVRAAG:	SCHAAL:	GETEKEND: MN	LEVERWEEK:	1.2a P.71
-----------	---------	-----------------	------------	-----------

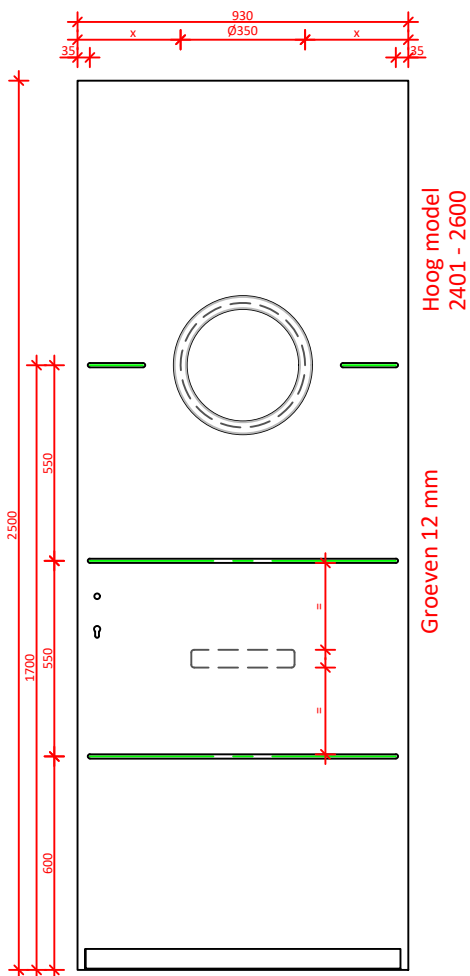
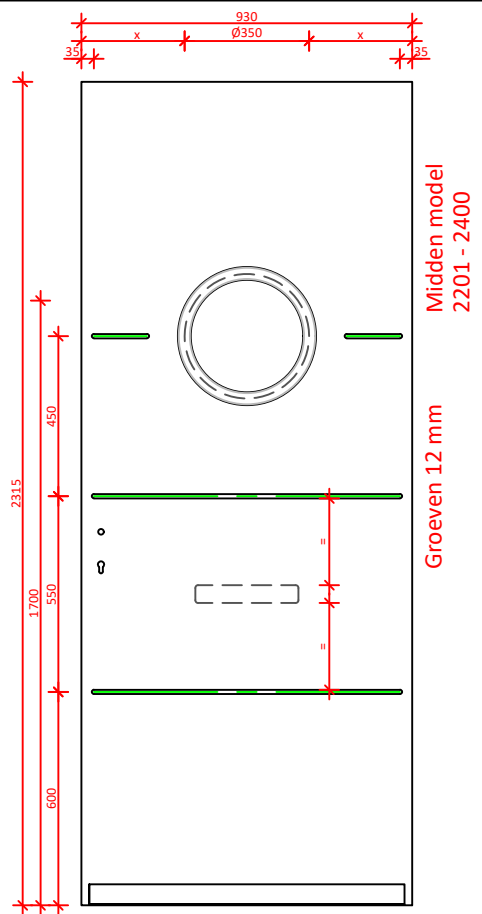
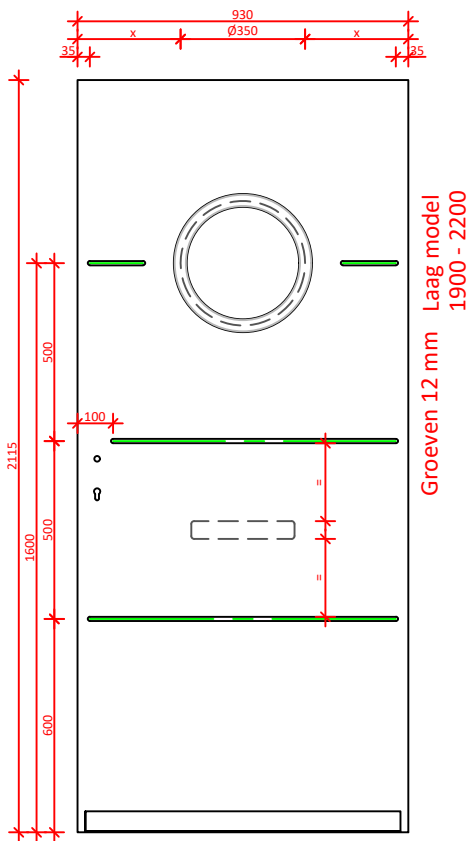

DATUM:	GEWIJZIGD:	CALCULATIENR:	TEKENINGNR: 9807N	MODEL:	HOUTSOORT:
--------	------------	---------------	----------------------	--------	------------

	KLANT/PROJECT: overzicht modellen 9807N			DCM NUMMER:
--	--	--	--	-------------

AANVRAAG:	SCHAAL:	GETEKEND:	LEVERWEEK:	1.2a P.72
-----------	---------	-----------	------------	-----------

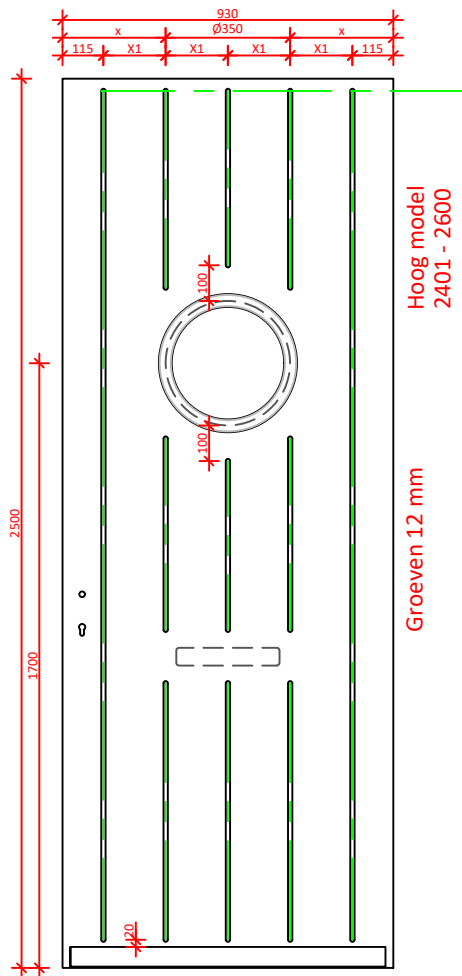
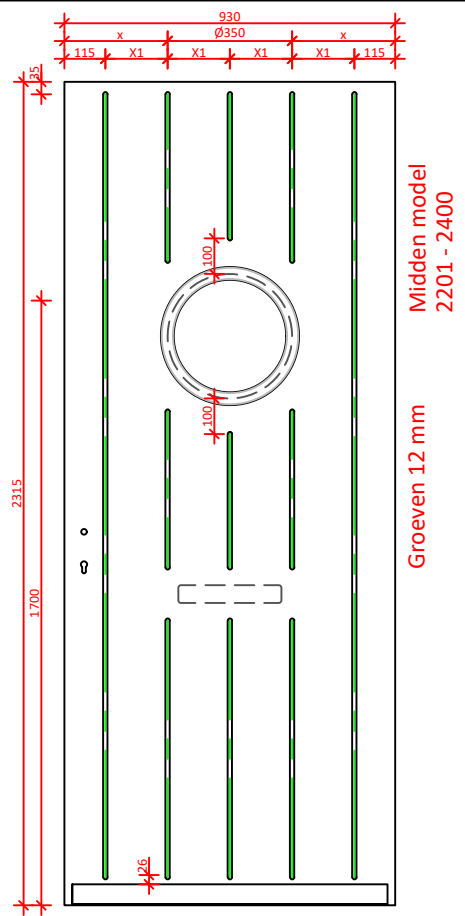
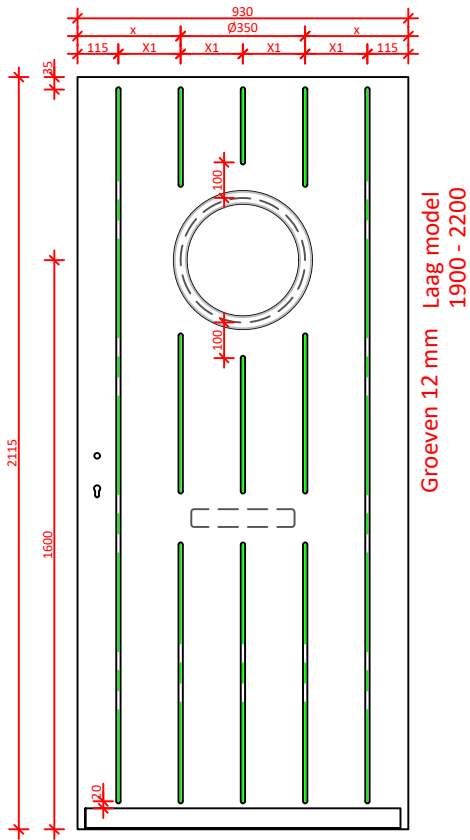

DATUM:	GEWIJZIGD:	CALCULATIENR:	TEKENINGNR: 9808N	MODEL:	HOUTSOORT:
--------	------------	---------------	----------------------	--------	------------

KLANT/PROJECT: overzicht modellen 9808N met briefsleuf			DCM NUMMER:	
AANVRAAG:	SCHAAL:	GETEKEND:	LEVERWEEK: 1.2a P.73	

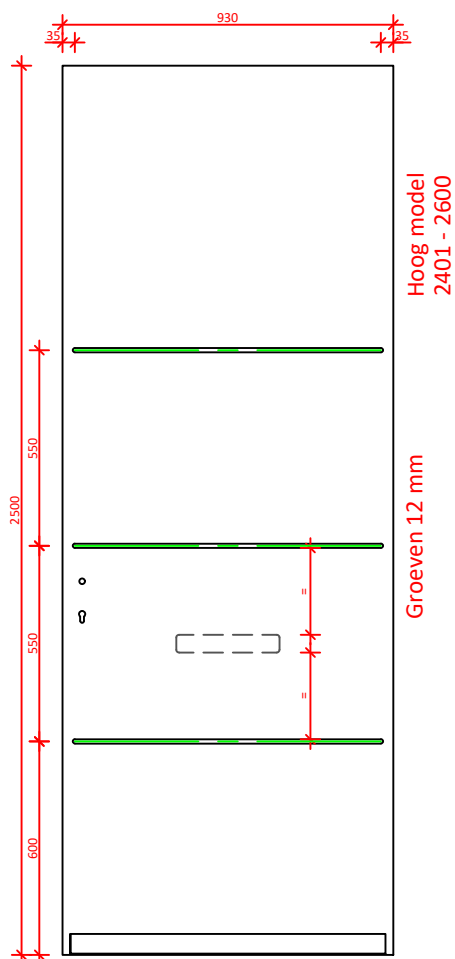
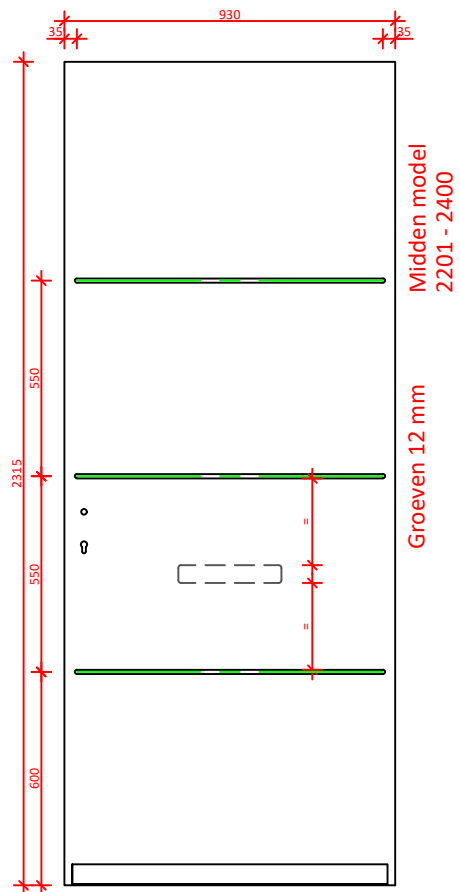
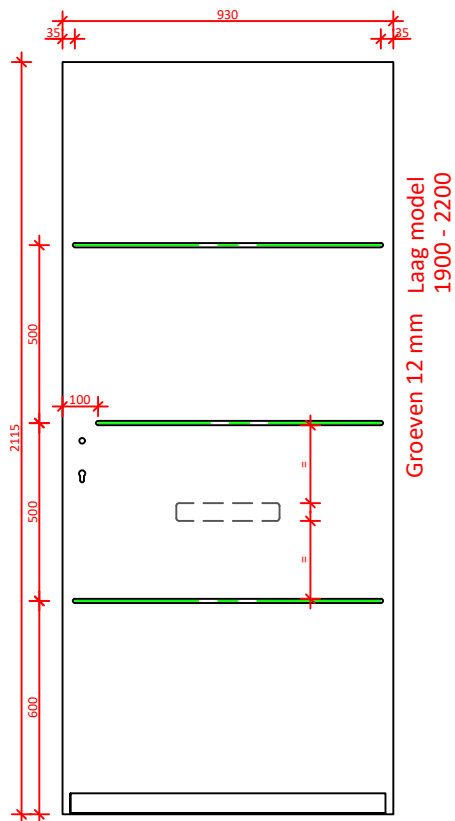

DATUM:	GEWIJZIGD:	CALCULATIENR:	TEKENINGNR: 9813N	MODEL:	HOUTSOORT:
--------	------------	---------------	----------------------	--------	------------

<b>KEGRO   DEUREN</b>	KLANT/PROJECT: overzicht modellen 9813N			DCM NUMMER:
-----------------------	--	--	--	-------------

AANVRAAG:	SCHAAL:	GETEKEND:	LEVERWEEK:	1.2a P.74
-----------	---------	-----------	------------	-----------

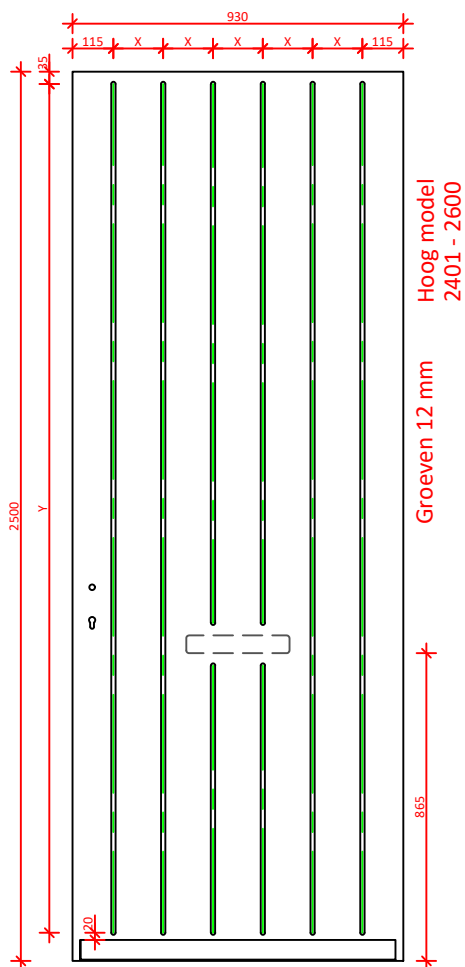
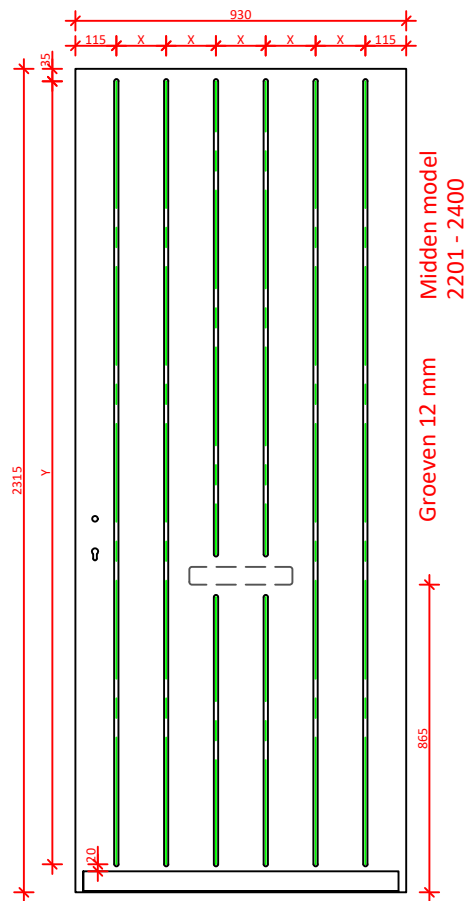
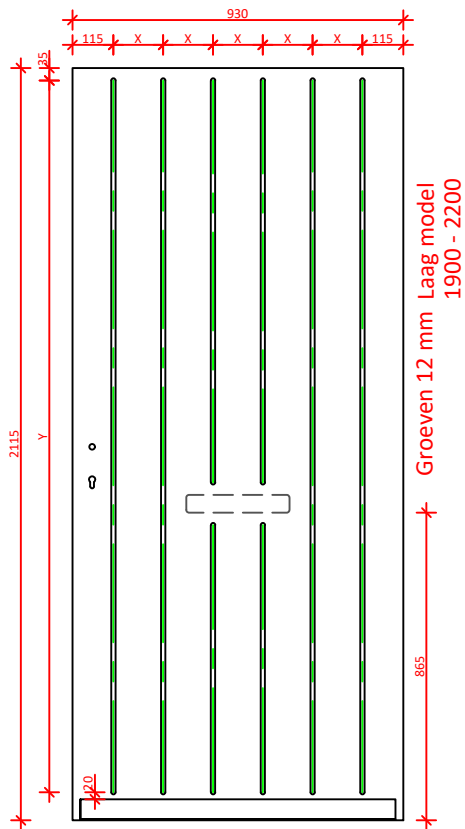

DATUM:	GEWIJZIGD:	CALCULATIENR:	TEKENINGNR:	MODEL: 9814	HOUTSOORT:
--------	------------	---------------	-------------	----------------	------------

	KLANT/PROJECT: overzicht modellen 9814			DCM NUMMER:
--	---	--	--	-------------

AANVRAAG:	SCHAAL:	GETEKEND: MN	LEVERWEEK: 1.2a P.75
-----------	---------	-----------------	-------------------------

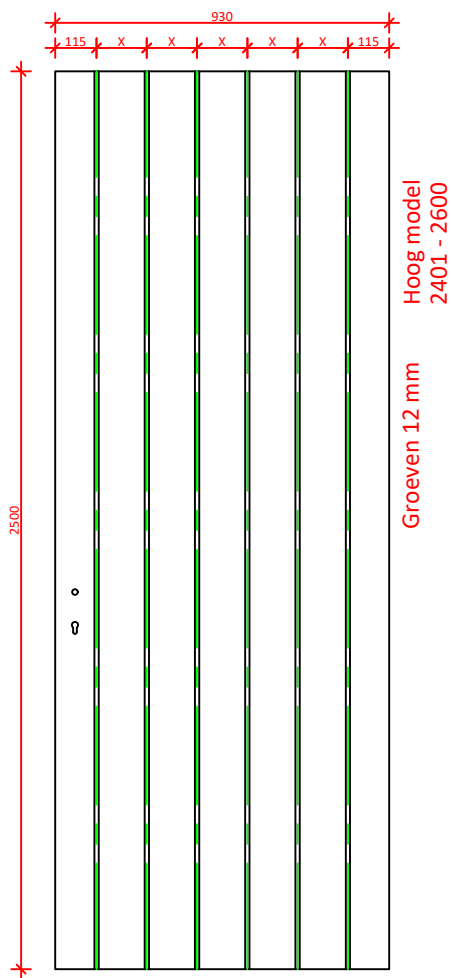
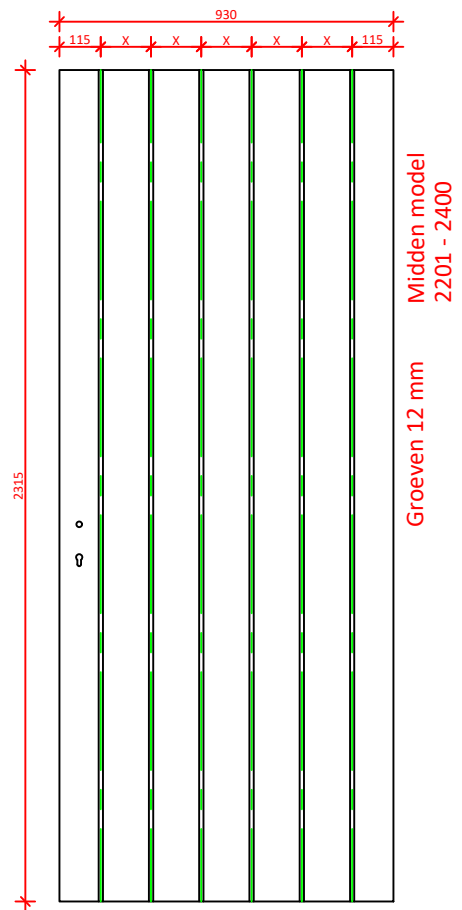
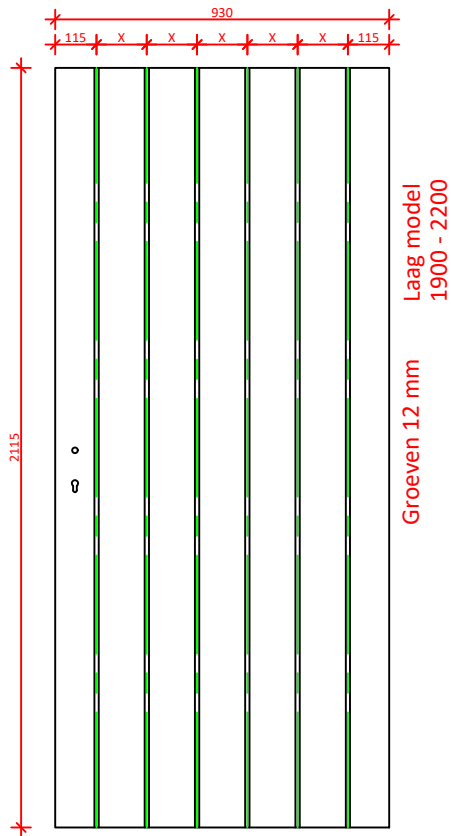

DATUM:	GEWIJZIGD:	CALCULATIENR:	TEKENINGNR: 9815	MODEL: 9815	HOUTSOORT:
--------	------------	---------------	---------------------	----------------	------------

	KLANT/PROJECT: overzicht modellen 9815			DCM NUMMER:
--	---	--	--	-------------

AANVRAAG:	SCHAAL:	GETEKEND: MN	LEVERWEEK: 1.2a P.76
-----------	---------	-----------------	-------------------------



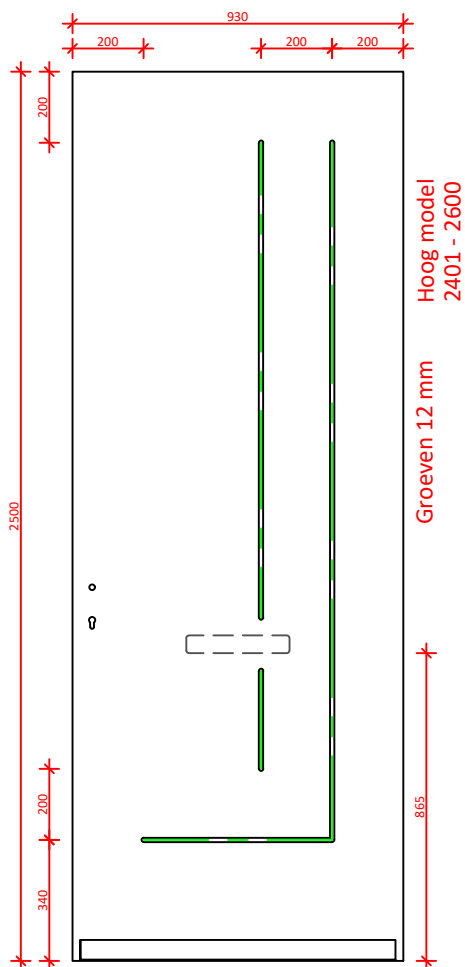
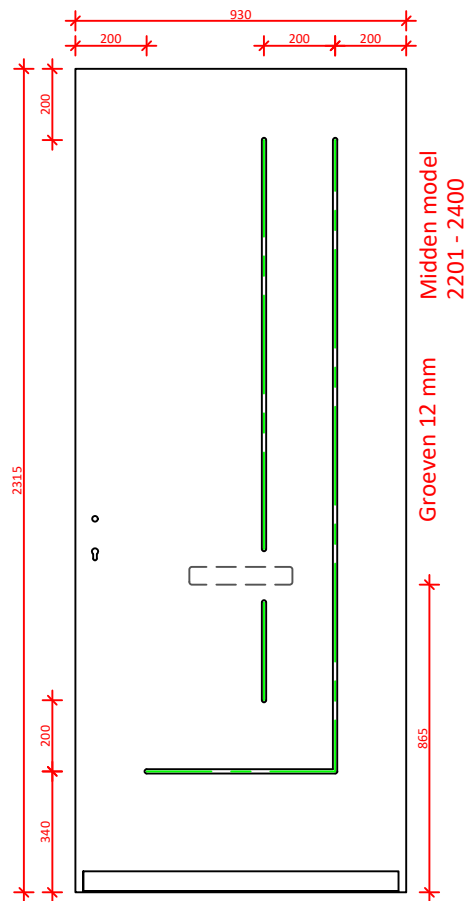
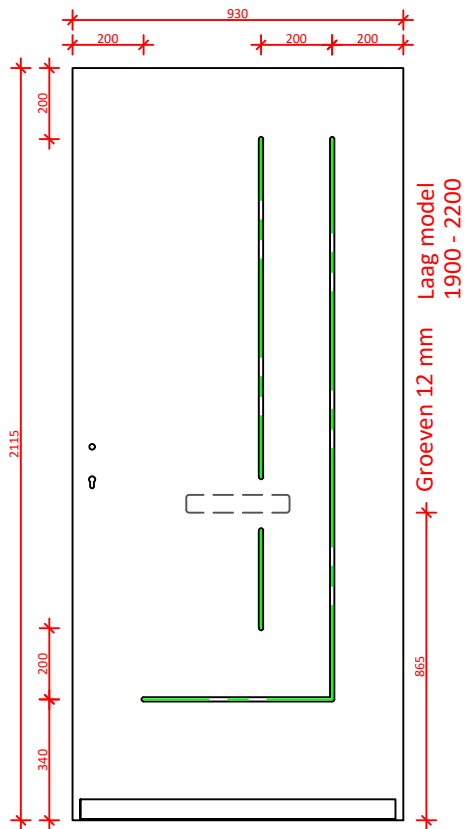

DATUM:	GEWIJZIGD:	CALCULATIENR:	TEKENINGNR:	MODEL: 9816	HOUTSOORT:
--------	------------	---------------	-------------	----------------	------------

	KLANT/PROJECT: overzicht modellen 9816 met briefsleuf			DCM NUMMER:
--	--	--	--	-------------

AANVRAAG:	SCHAAL:	GETEKEND: MN	LEVERWEEK:	1.2a P.77
-----------	---------	-----------------	------------	-----------

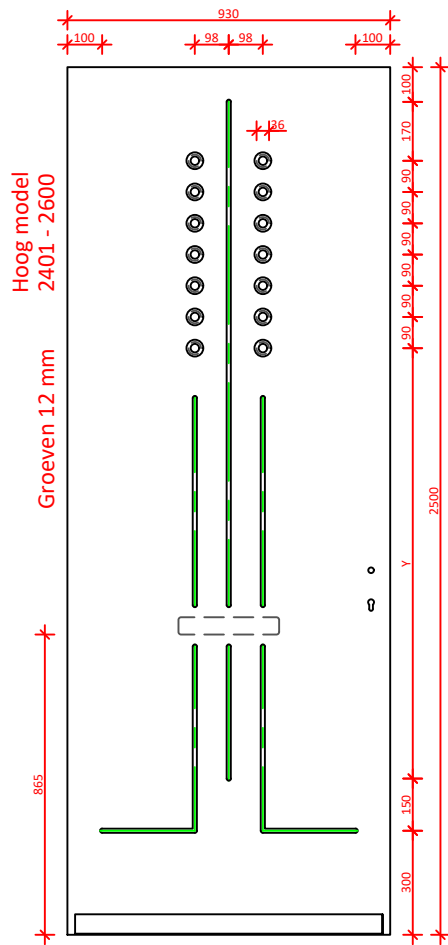
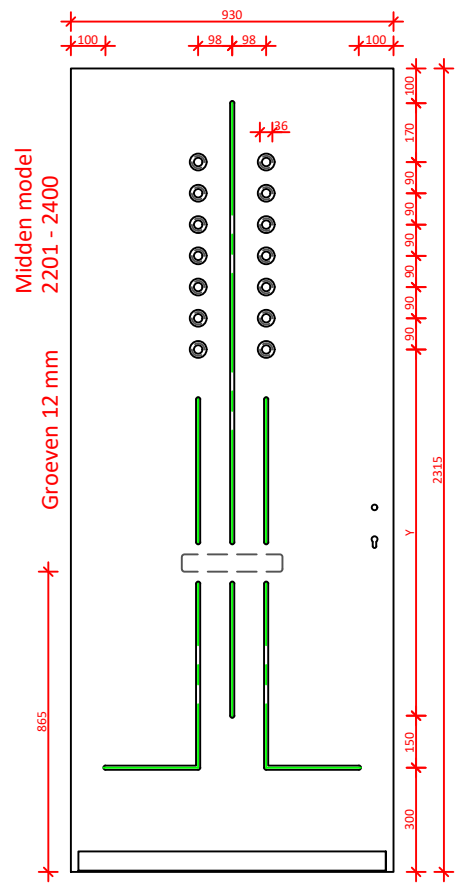
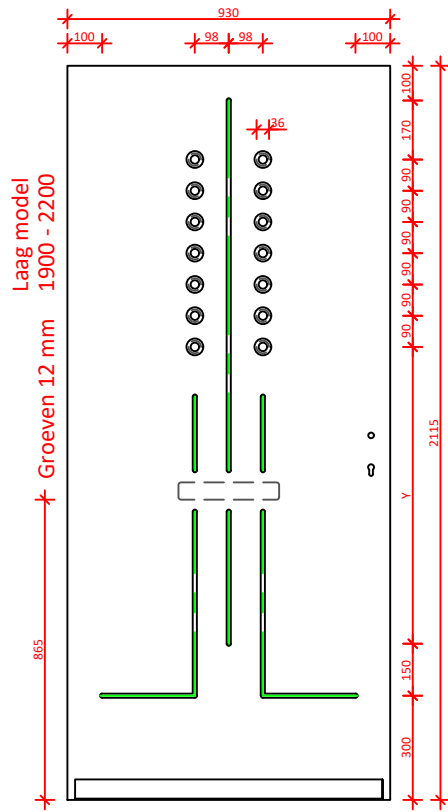

DATUM:	GEWIJZIGD:	CALCULATIENR:	TEKENINGNR:	MODEL: 9817	HOUTSOORT:
--------	------------	---------------	-------------	----------------	------------

	KLANT/PROJECT: overzicht modellen 9817 met briefsleuf R2 - L3			DCM NUMMER:
--	--	--	--	-------------

AANVRAAG:	SCHAAL:	GETEKEND: MN	LEVERWEEK:	1.2a P.78
-----------	---------	-----------------	------------	-----------

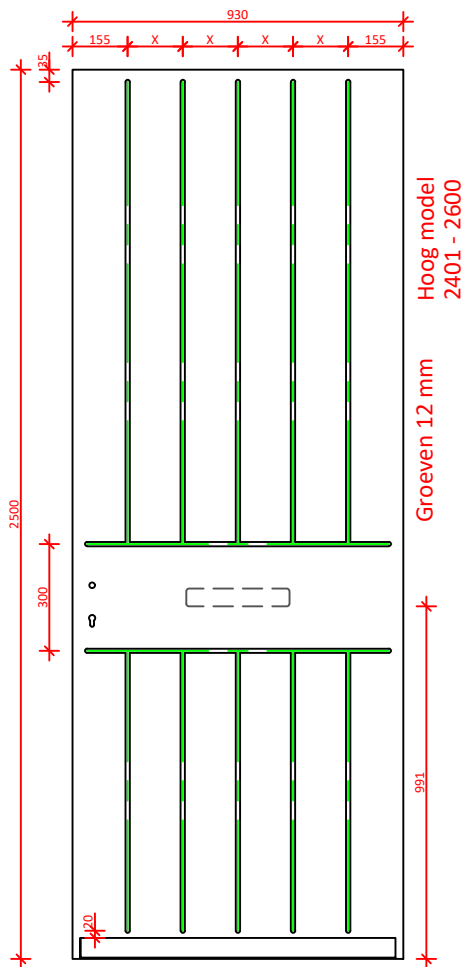
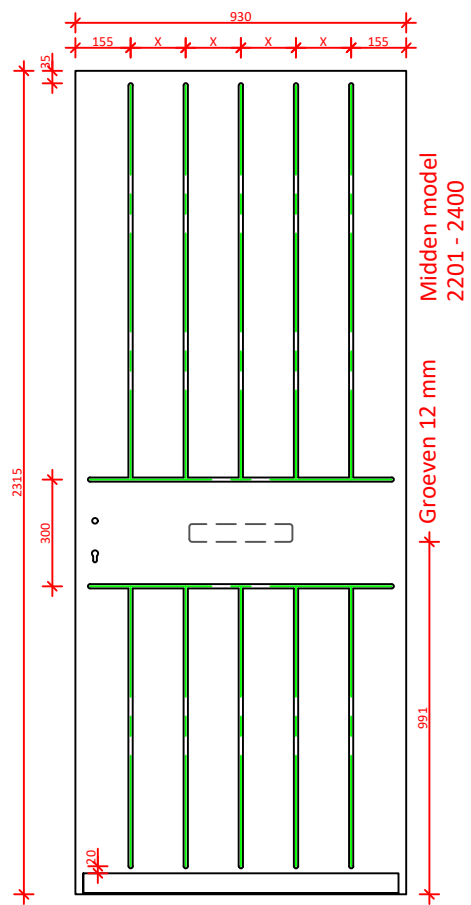
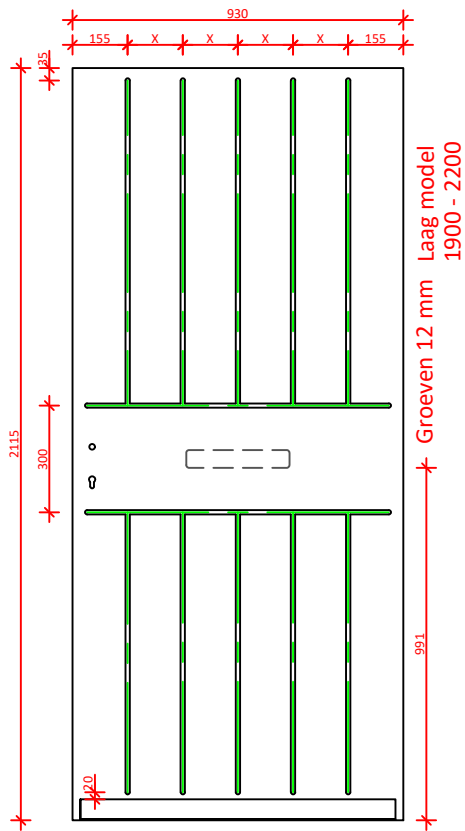

DATUM:	GEWIJZIGD:	CALCULATIENR:	TEKENINGNR:	MODEL: 9821	HOUTSOORT:
--------	------------	---------------	-------------	----------------	------------

	KLANT/PROJECT: overzicht modellen 9821			DCM NUMMER:
--	---	--	--	-------------

AANVRAAG:	SCHAAL:	GETEKEND: MN	LEVERWEEK: 1.2a P.79
-----------	---------	-----------------	-------------------------

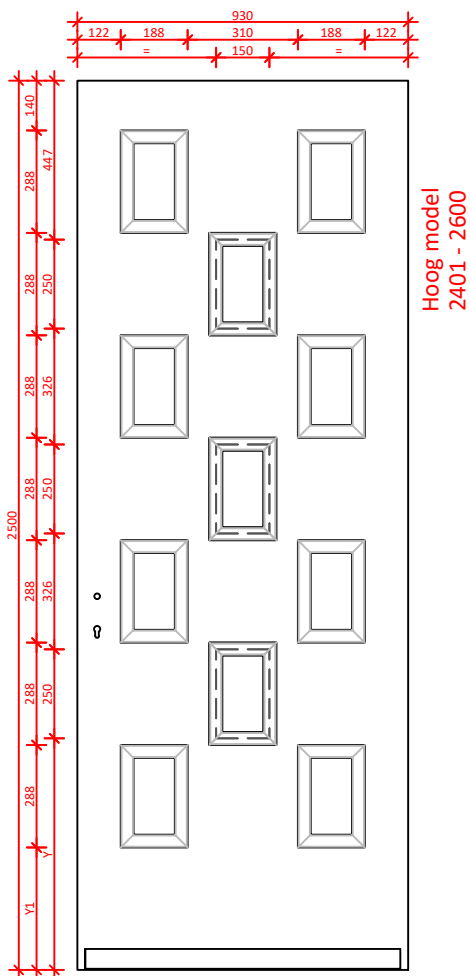
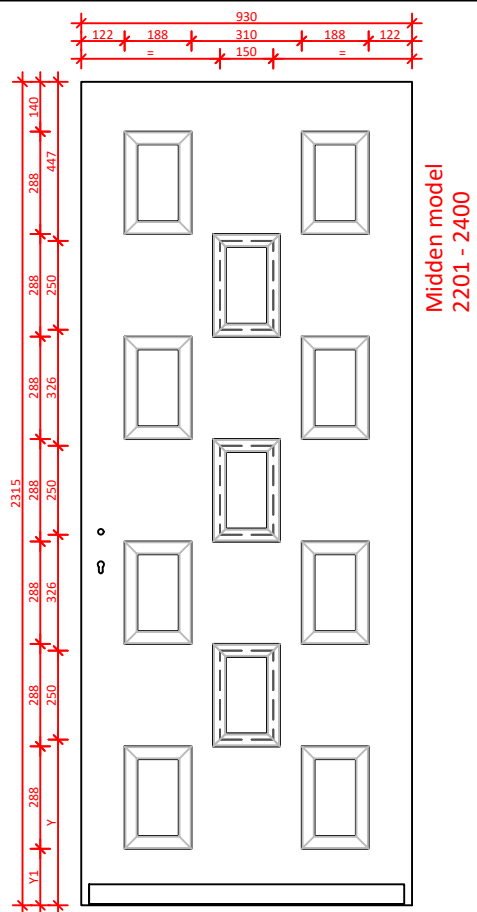
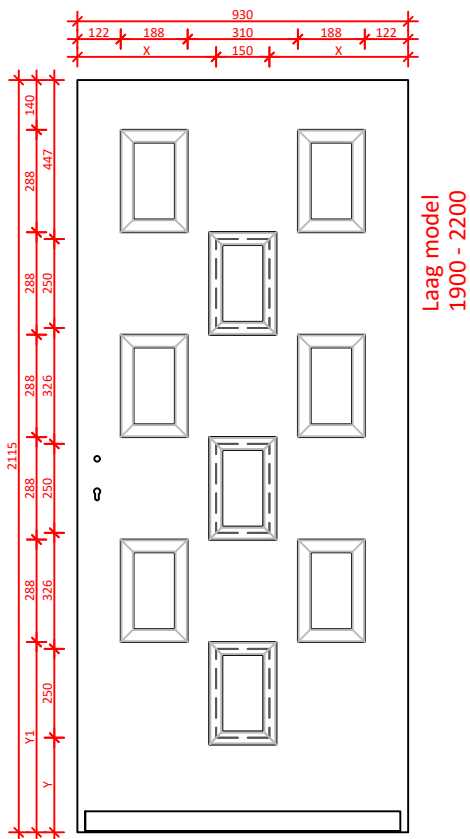

DATUM:	GEWIJZIGD:	CALCULATIENR:	TEKENINGNR:	MODEL: 9823N	HOUTSOORT:
--------	------------	---------------	-------------	-----------------	------------

	KLANT/PROJECT: overzicht modellen 9823N			DCM NUMMER:
--	--	--	--	-------------

AANVRAAG:	SCHAAL:	GETEKEND: MN	LEVERWEEK:	1.2a P.80
-----------	---------	-----------------	------------	-----------

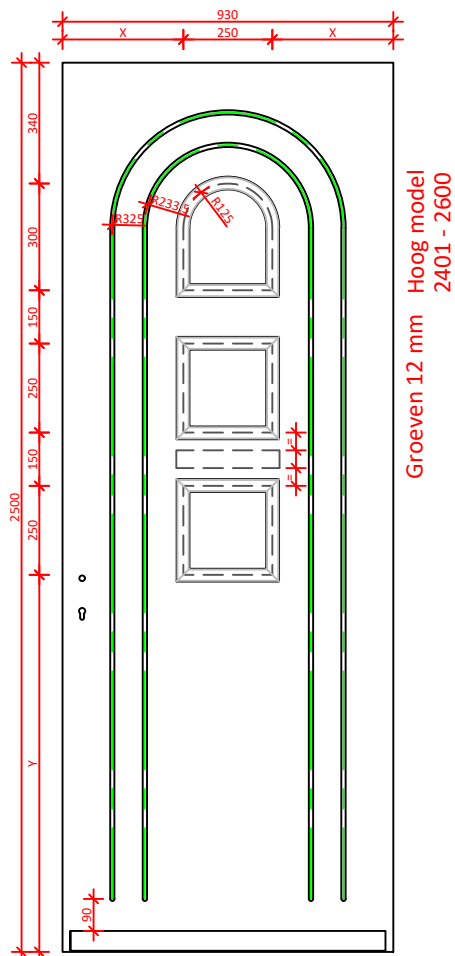
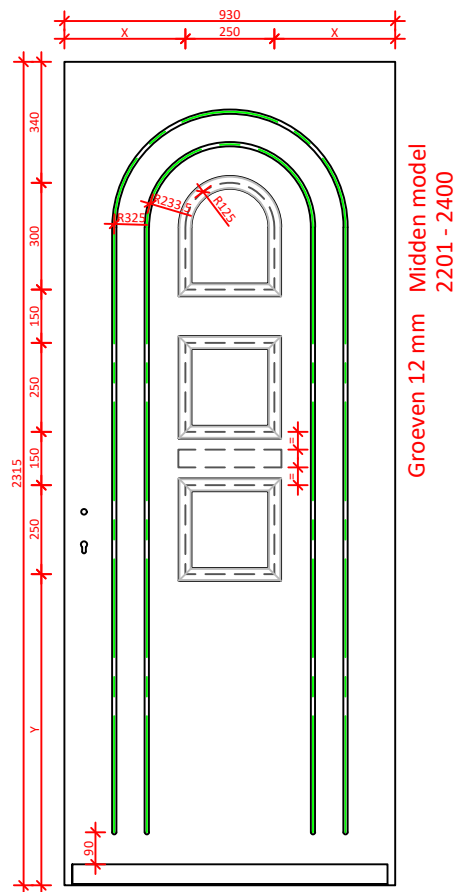
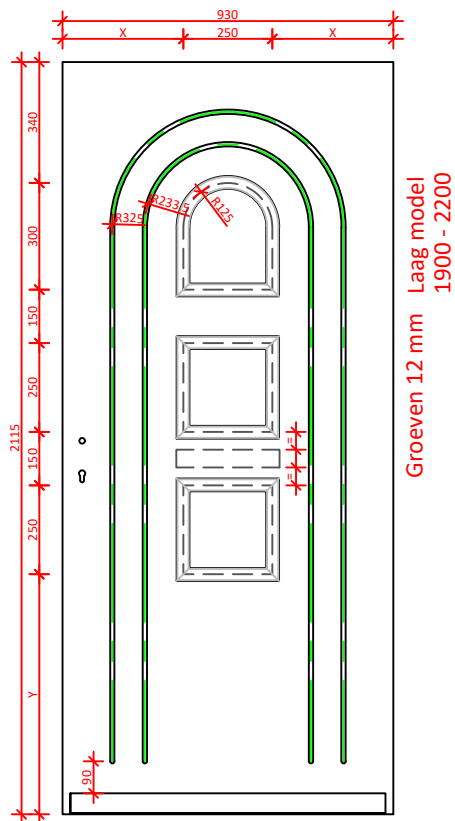

DATUM:	GEWIJZIGD:	CALCULATIENR:	TEKENINGNR:	MODEL: 9825N	HOUTSOORT:
--------	------------	---------------	-------------	-----------------	------------

<b>KEGRO   DEUREN</b>	KLANT/PROJECT: overzicht modellen 9825N			DCM NUMMER:
-----------------------	--	--	--	-------------

AANVRAAG:	SCHAAL:	GETEKEND: MN	LEVERWEEK: 1.2a P.81
-----------	---------	-----------------	-------------------------

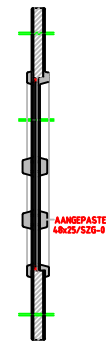
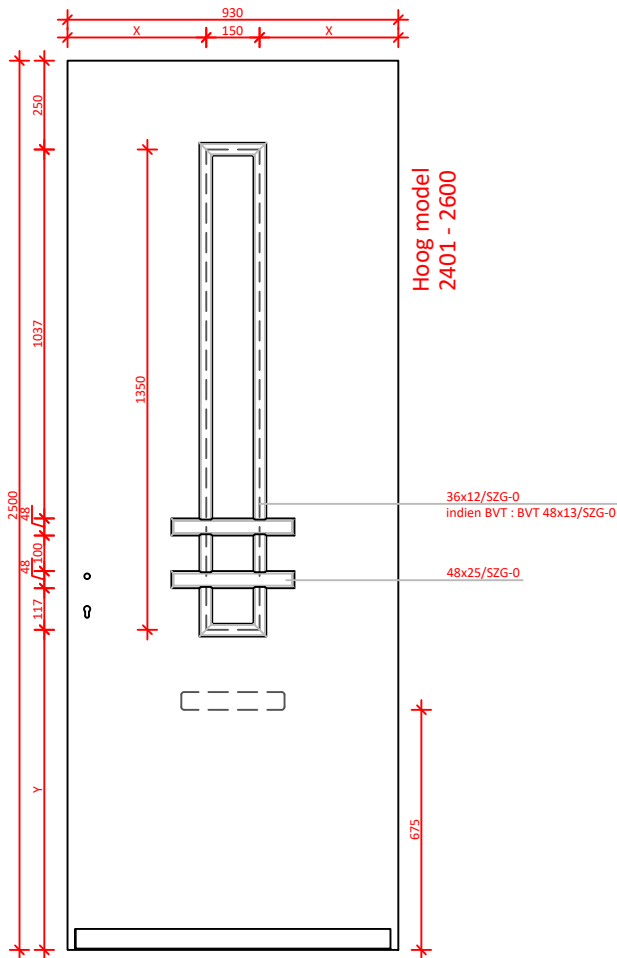
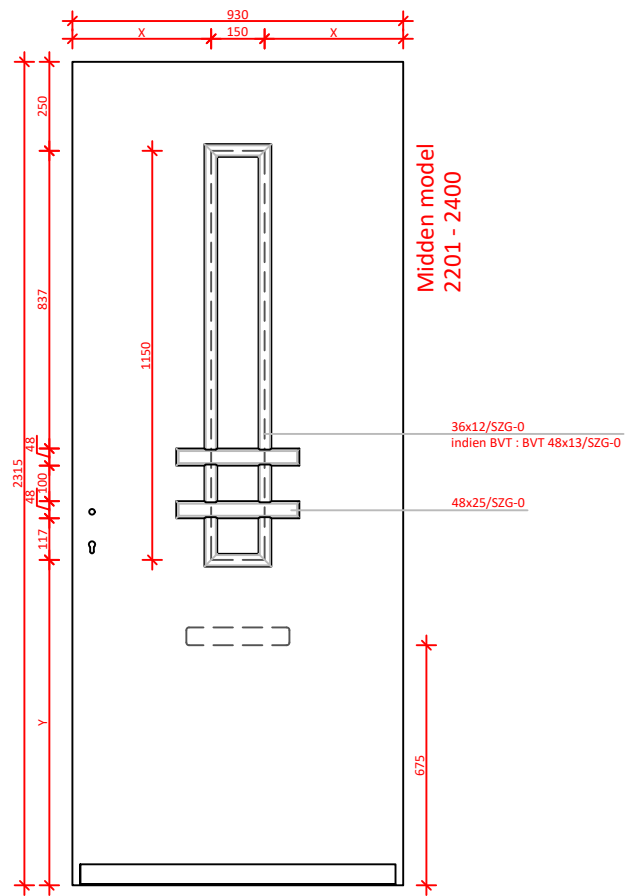
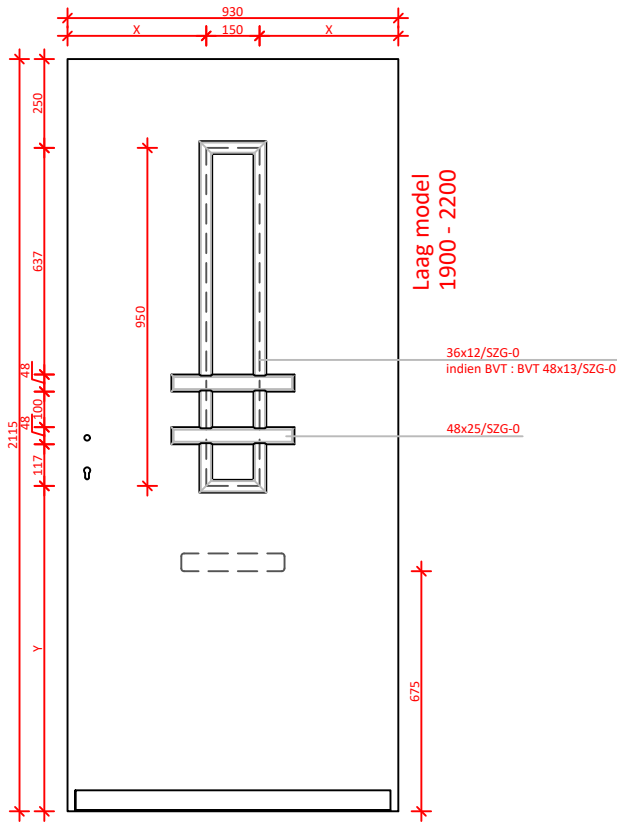

DATUM:	GEWIJZIGD:	CALCULATIENR:	TEKENINGNR: 9828N	MODEL:	HOUTSOORT:
--------	------------	---------------	----------------------	--------	------------

<b>KEGRO   DEUREN</b>	KLANT/PROJECT: overzicht modellen 9828N			DCM NUMMER:
-----------------------	--	--	--	-------------

AANVRAAG:	SCHAAL:	GETEKEND:	LEVERWEEK:	1.2a P.82
-----------	---------	-----------	------------	-----------

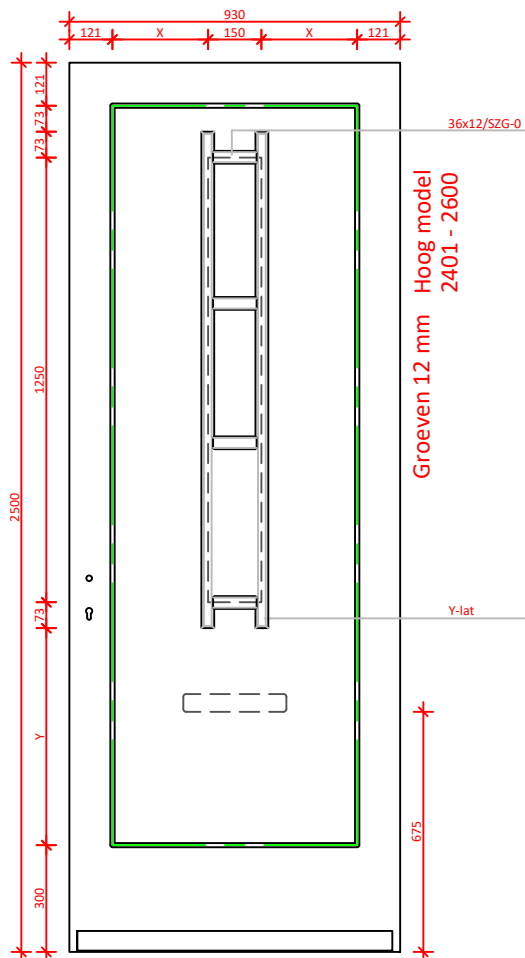
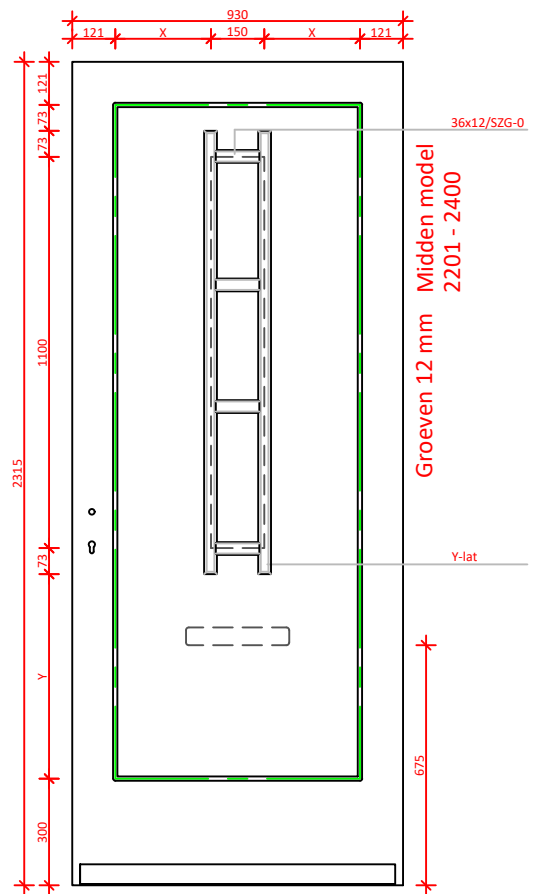
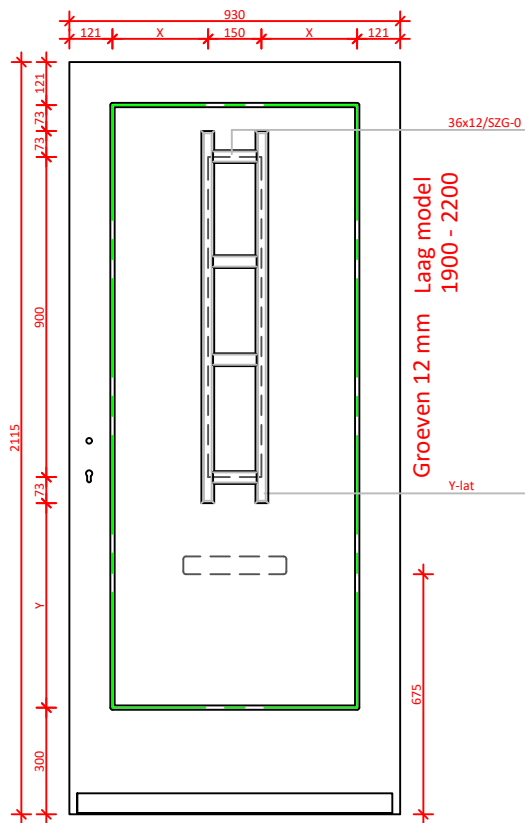

DATUM:	GEWIJZIGD:	CALCULATIENR:	TEKENINGNR: 9829N	MODEL:	HOUTSOORT:
--------	------------	---------------	----------------------	--------	------------

	KLANT/PROJECT: overzicht modellen 9829N			DCM NUMMER:
--	--	--	--	-------------

AANVRAAG:	SCHAAL:	GETEKEND:	LEVERWEEK:	1.2a P.83
-----------	---------	-----------	------------	-----------

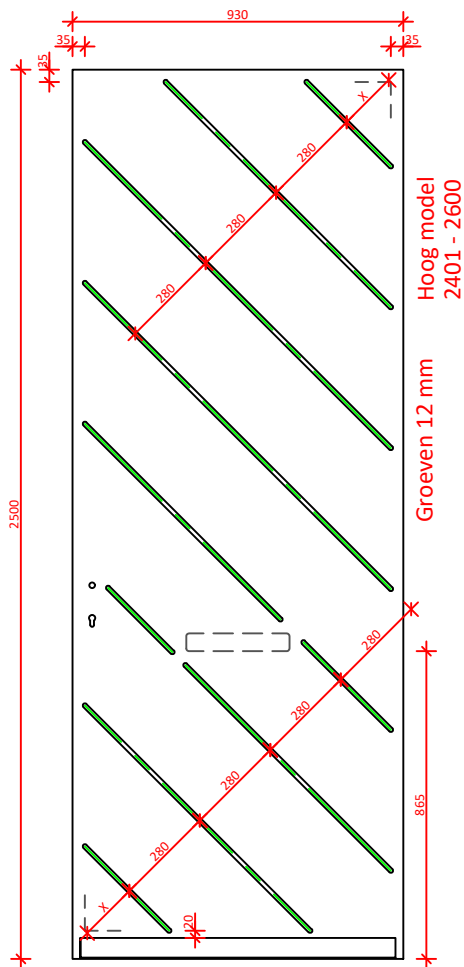
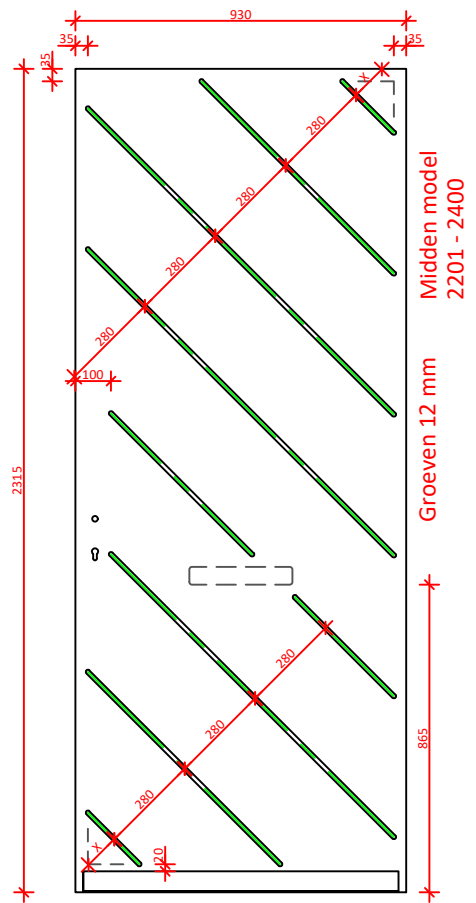
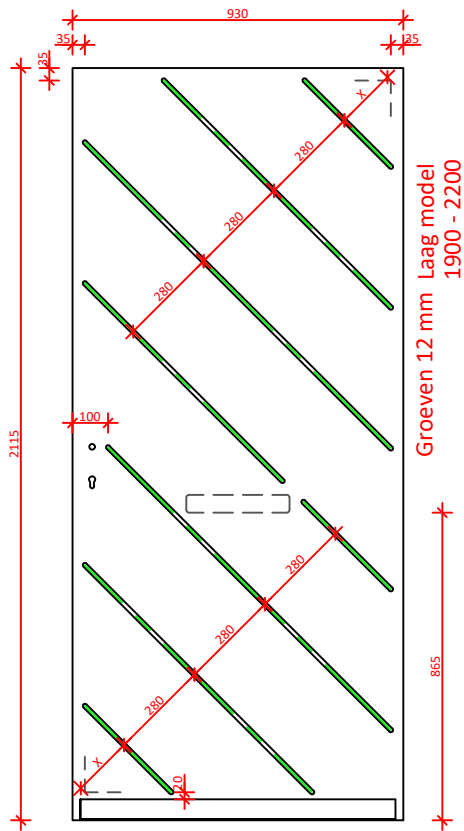

DATUM:	GEWIJZIGD:	CALCULATIENR:	TEKENINGNR:	MODEL: 9830	HOUTSOORT:
--------	------------	---------------	-------------	----------------	------------

	KLANT/PROJECT: overzicht modellen 9830 met briefsleuf			DCM NUMMER:
--	--	--	--	-------------

AANVRAAG:	SCHAAL:	GETEKEND: MN	LEVERWEEK:	1.2a P.84
-----------	---------	-----------------	------------	-----------



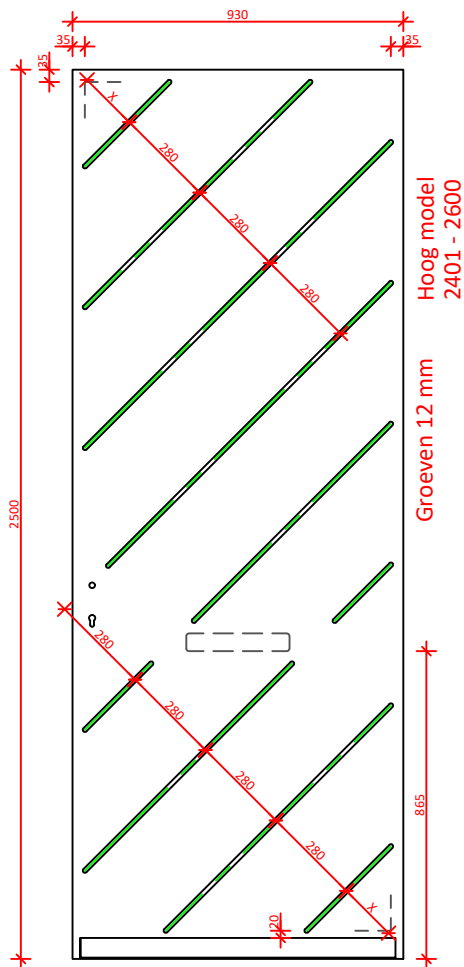
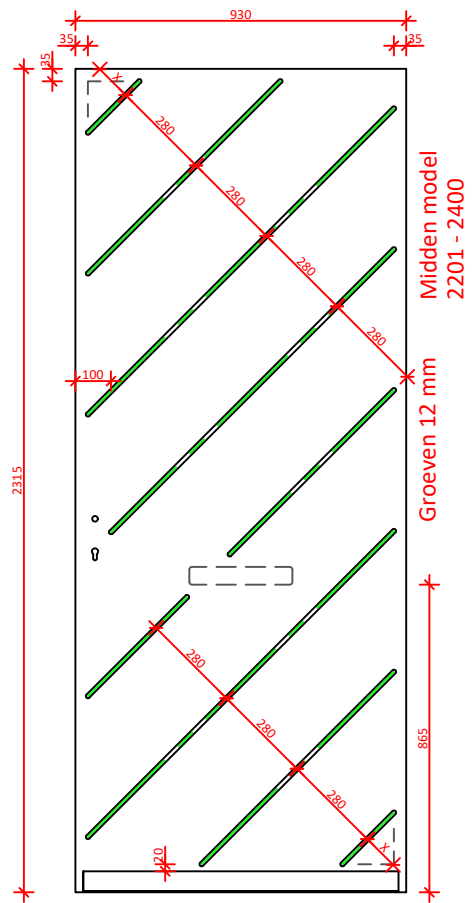
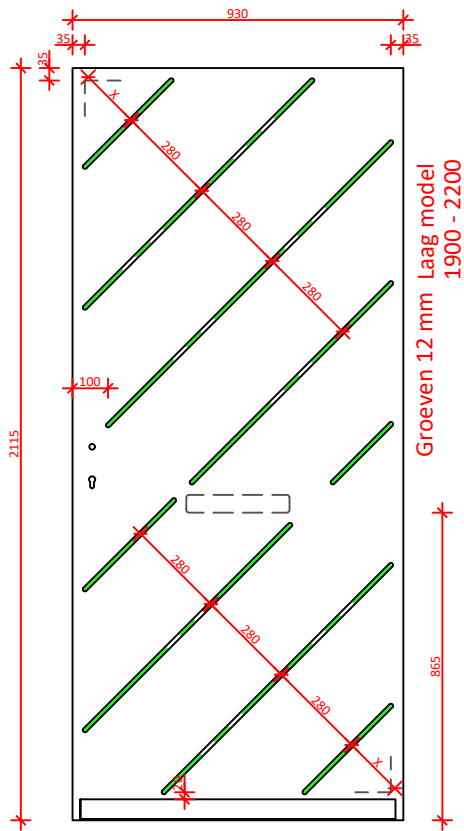

DATUM:	GEWIJZIGD:	CALCULATIENR:	TEKENINGNR:	MODEL: 9831	HOUTSOORT:
--------	------------	---------------	-------------	----------------	------------

	KLANT/PROJECT: overzicht modellen 9831 met briefsleuf			DCM NUMMER:
--	--	--	--	-------------

AANVRAAG:	SCHAAL:	GETEKEND: MN	LEVERWEEK:	1.2a P.85
-----------	---------	-----------------	------------	-----------

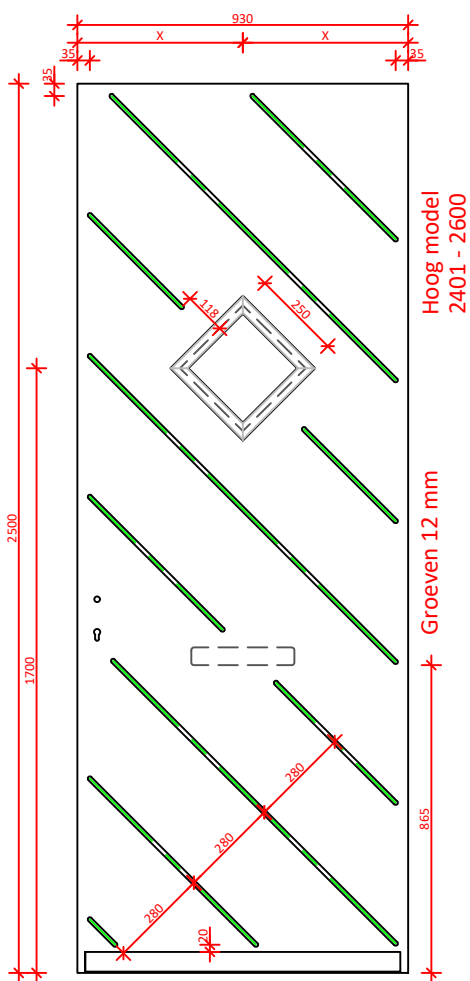
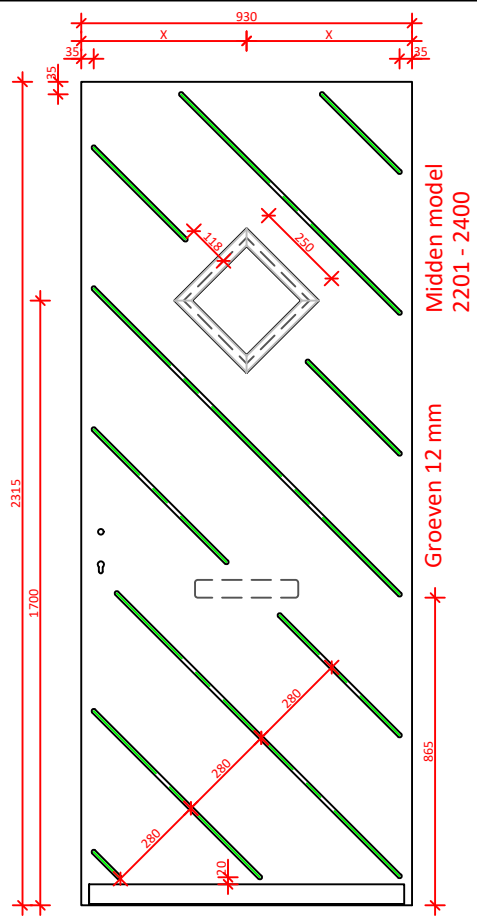
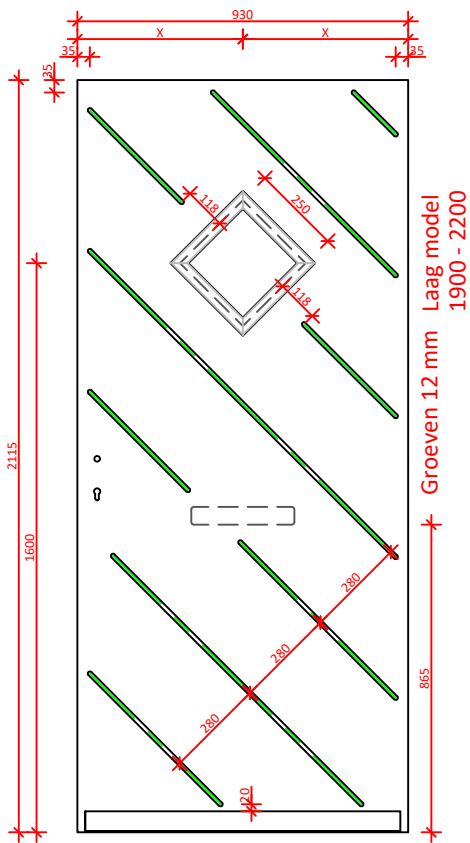

DATUM:	GEWIJZIGD:	CALCULATIENR:	TEKENINGNR:	MODEL: 9832N	HOUTSOORT:
--------	------------	---------------	-------------	-----------------	------------

	KLANT/PROJECT: overzicht modellen 9832N met briefsleuf			DCM NUMMER:
--	---	--	--	-------------

AANVRAAG:	SCHAAL:	GETEKEND: MN	LEVERWEEK:	1.2a P.86
-----------	---------	-----------------	------------	-----------



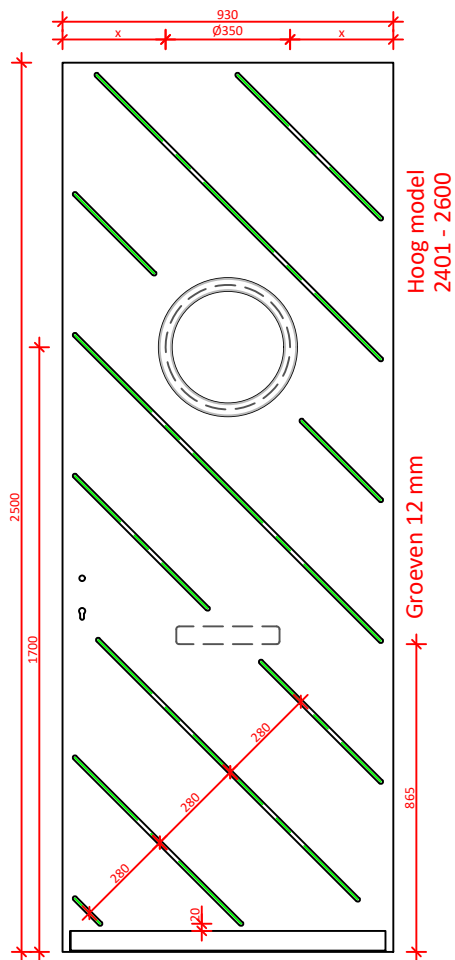
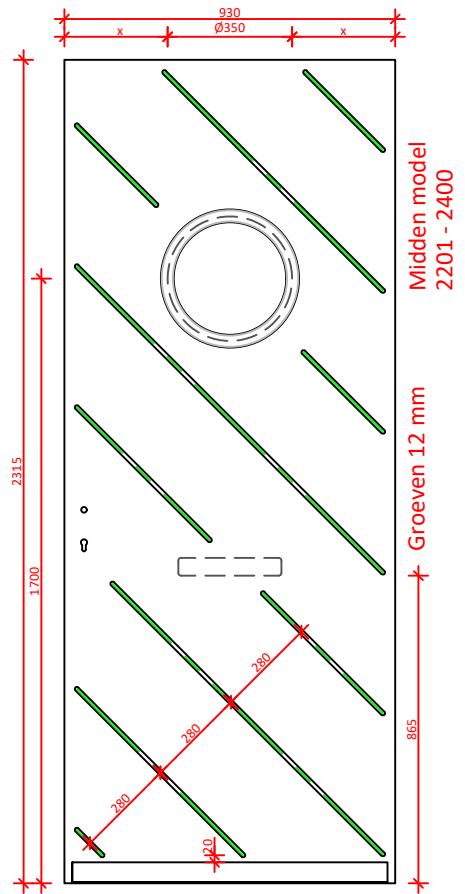
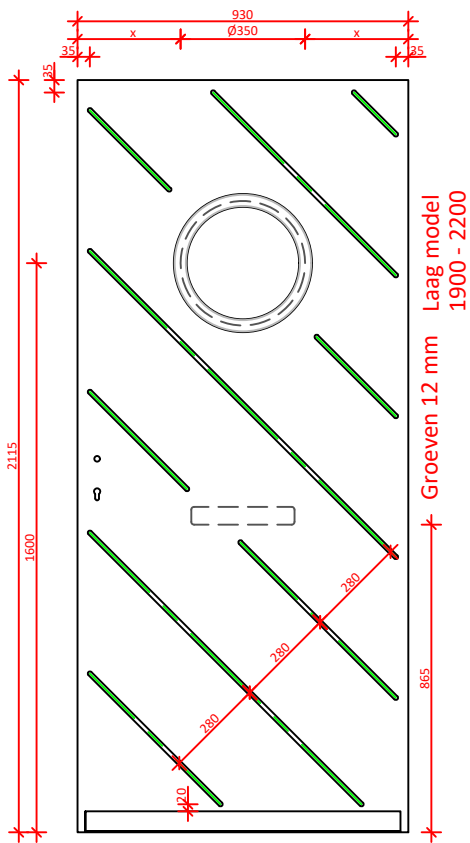

DATUM:	GEWIJZIGD:	CALCULATIENR:	TEKENINGNR: 9834N	MODEL:	HOUTSOORT:
--------	------------	---------------	----------------------	--------	------------

<b>KEGRO   DEUREN</b>	KLANT/PROJECT: overzicht modellen 9834N met briefstuf			DCM NUMMER:
-----------------------	--	--	--	-------------

AANVRAAG:	SCHAAL:	GETEKEND:	LEVERWEEK:	1.2a P.88
-----------	---------	-----------	------------	-----------

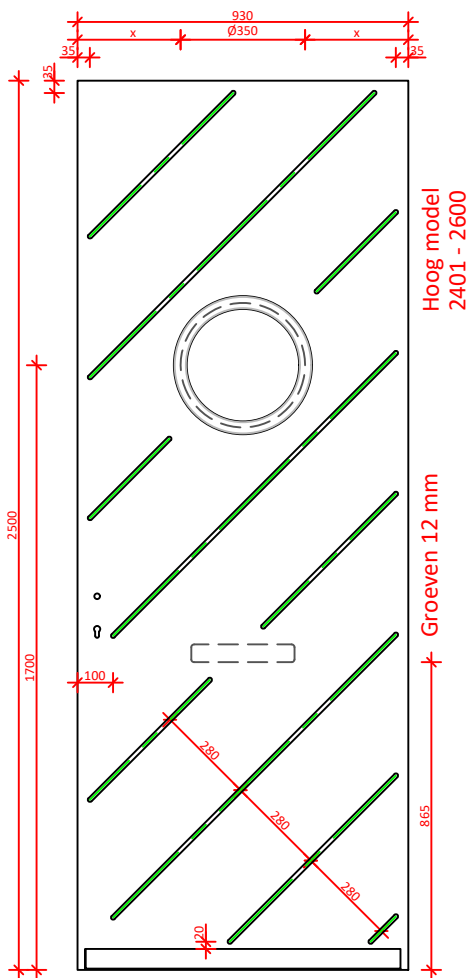
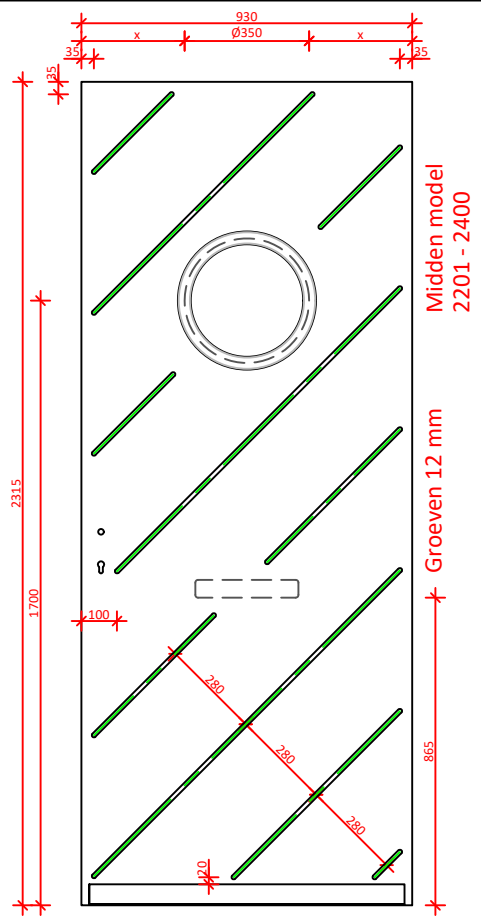
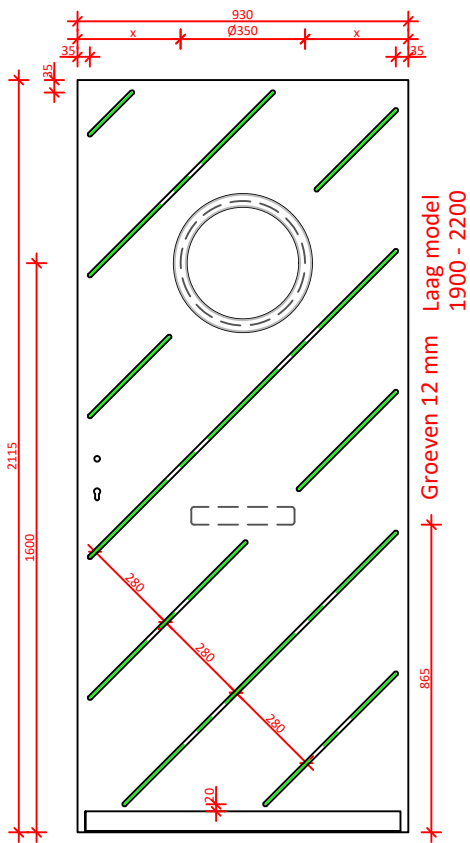

DATUM:	GEWIJZIGD:	CALCULATIENR:	TEKENINGNR: 9835N	MODEL:	HOUTSOORT:
--------	------------	---------------	----------------------	--------	------------

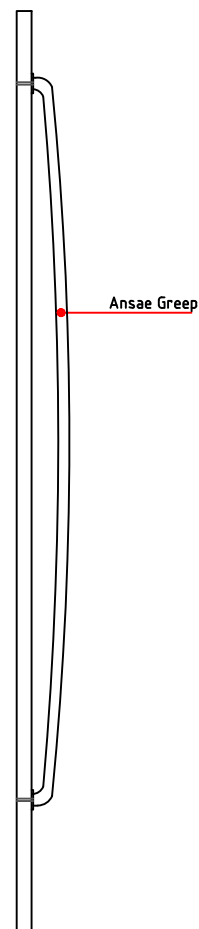
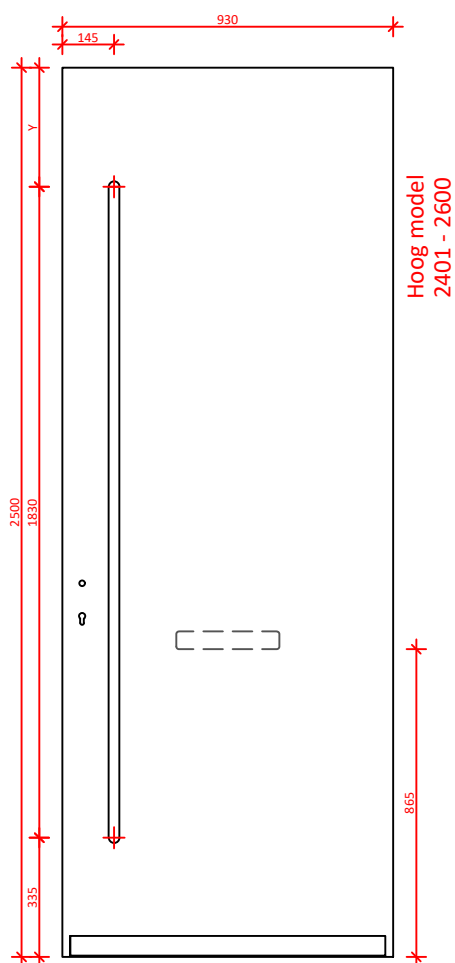
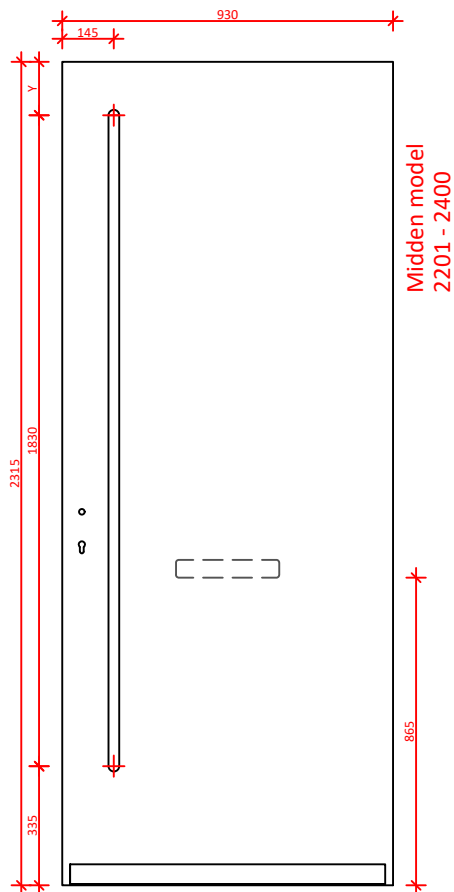
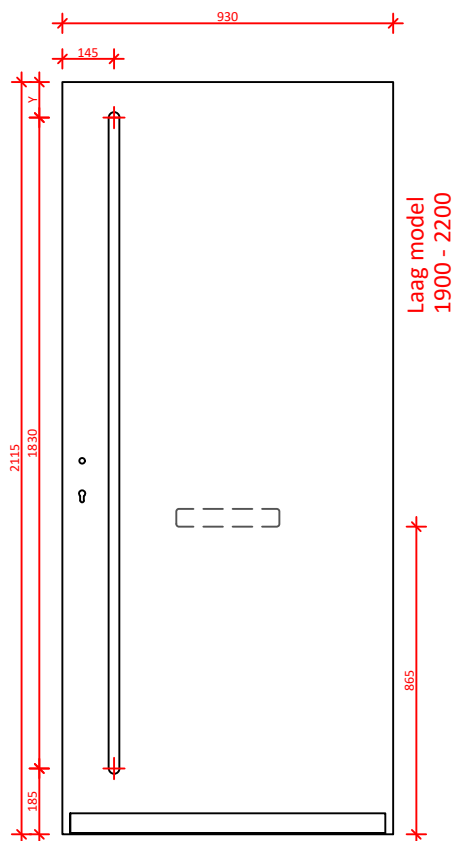

DATUM:	GEWIJZIGD:	CALCULATIENR:	TEKENINGNR:	MODEL: 9837	HOUTSOORT:
--------	------------	---------------	-------------	----------------	------------

	KLANT/PROJECT: overzicht modellen 9837			DCM NUMMER:
--	---	--	--	-------------

AANVRAAG:	SCHAAL:	GETEKEND: MN	LEVERWEEK:	1.2a P.90
-----------	---------	-----------------	------------	-----------



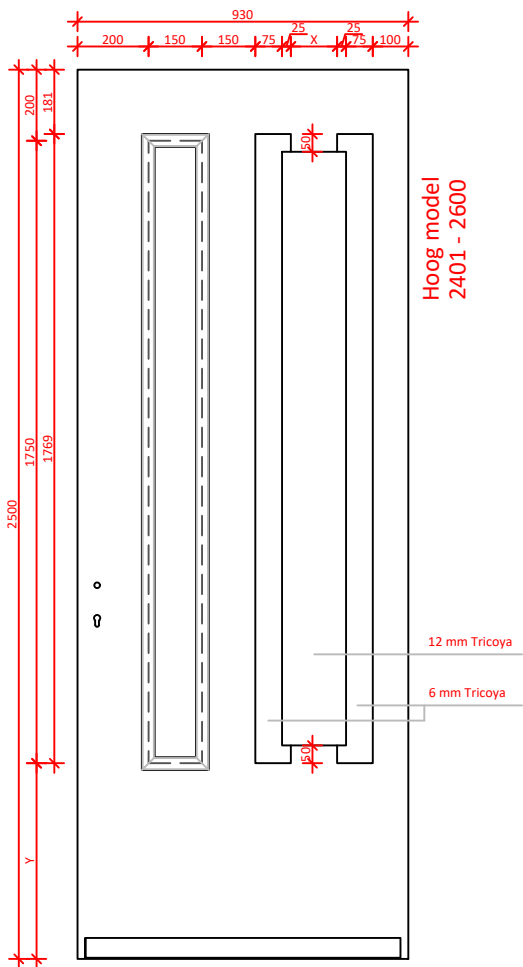
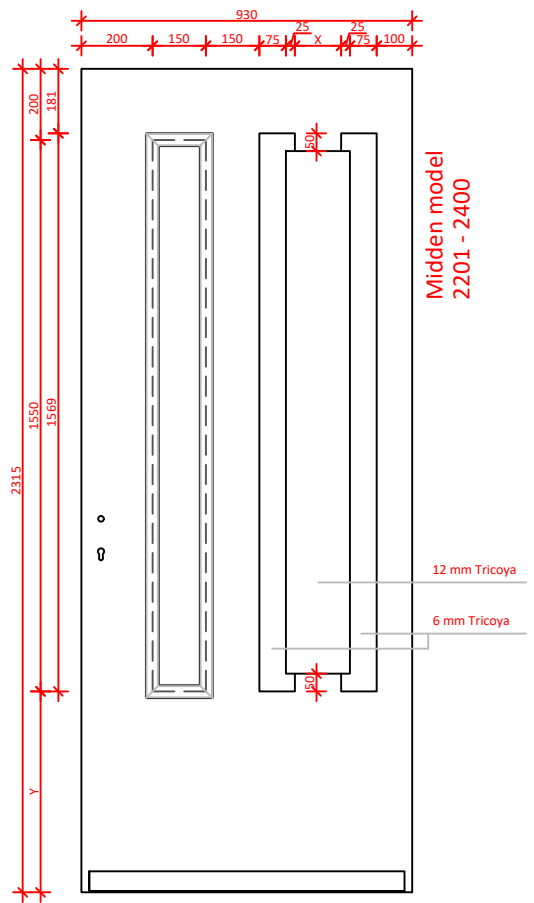
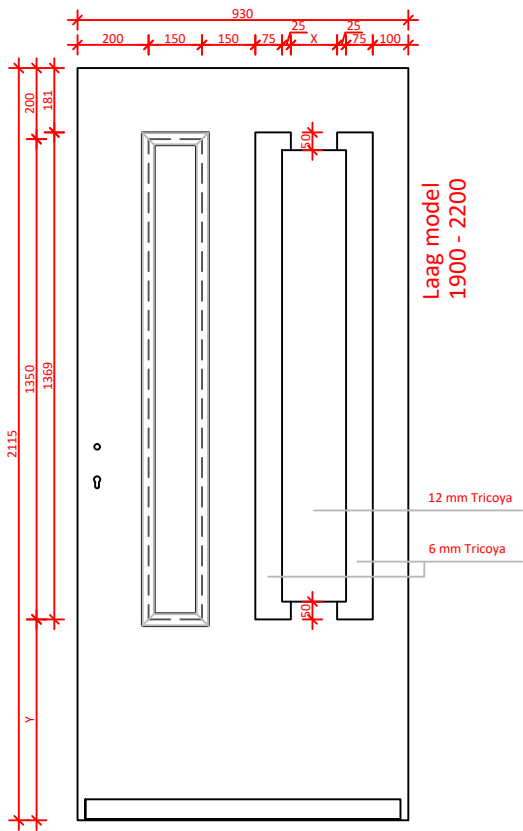

DATUM:	GEWIJZIGD:	CALCULATIENR:	TEKENINGNR:	MODEL: 9844N	HOUTSOORT:
--------	------------	---------------	-------------	-----------------	------------

	KLANT/PROJECT: overzicht modellen 9844N L1 - R4			DCM NUMMER:
--	--	--	--	-------------

AANVRAAG:	SCHAAL:	GETEKEND: MN	LEVERWEEK: 1.2a P.92
-----------	---------	-----------------	-------------------------



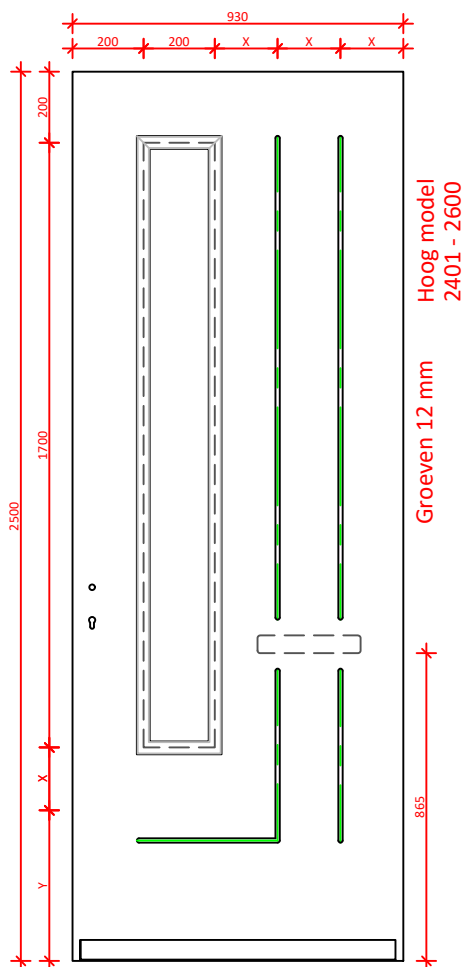
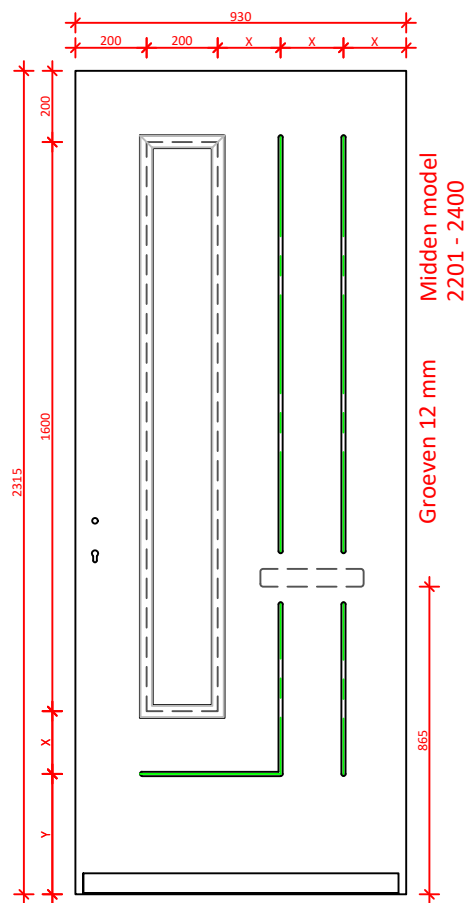
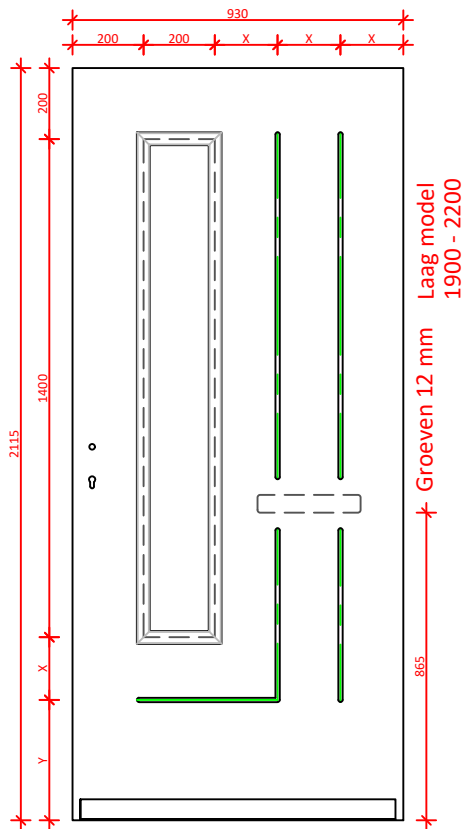

DATUM:	GEWIJZIGD:	CALCULATIENR:	TEKENINGNR:	MODEL: 9846N	HOUTSOORT:
--------	------------	---------------	-------------	-----------------	------------

	KLANT/PROJECT: overzicht modellen 9846N met briefsleuf			DCM NUMMER:
--	---	--	--	-------------

AANVRAAG:	SCHAAL:	GETEKEND: MN	LEVERWEEK:	1.2a P.93
-----------	---------	-----------------	------------	-----------

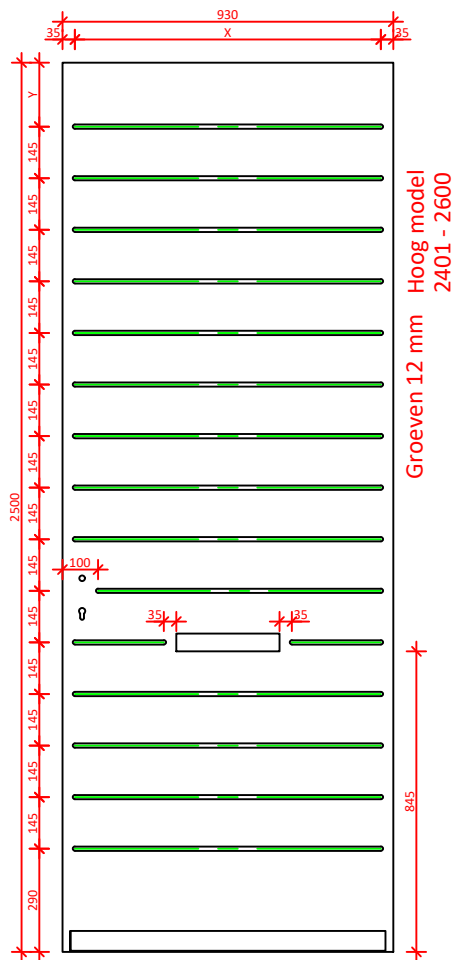
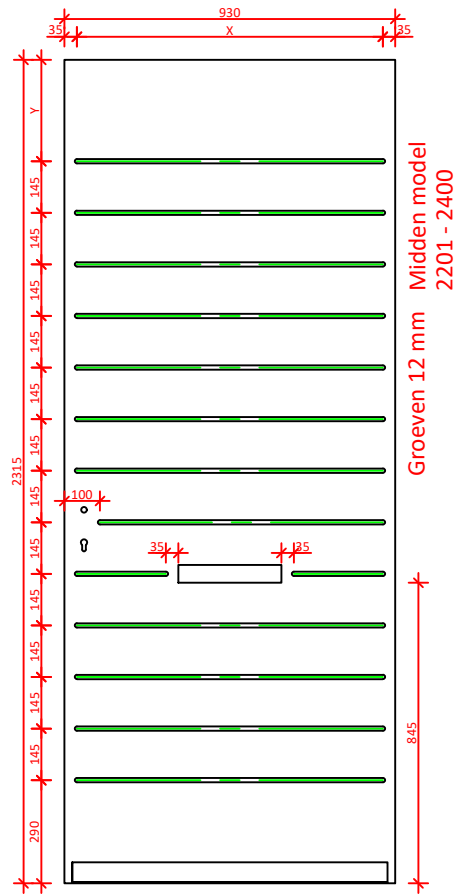
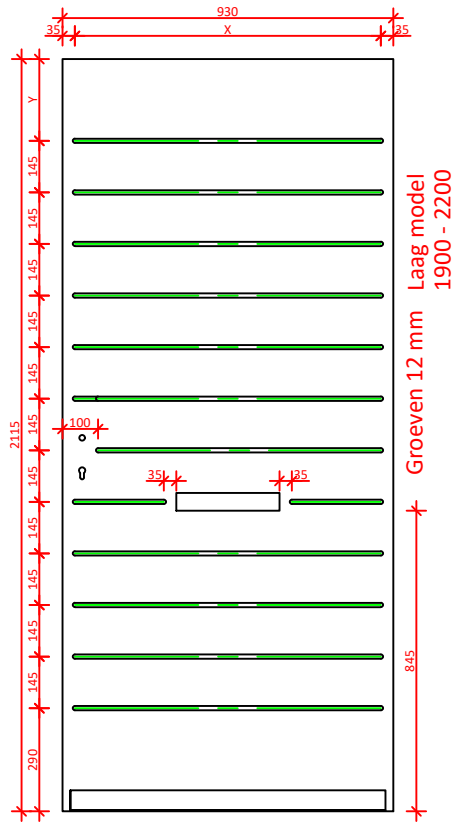

Rekening houden met slothoogte bij senioren schild

DATUM:	GEWIJZIGD:	CALCULATIENR:	TEKENINGNR:	MODEL: 9847N	HOUTSOORT:
--------	------------	---------------	-------------	-----------------	------------

	KLANT/PROJECT: overzicht modellen 9847N briefsleuf			DCM NUMMER:
--	---	--	--	-------------

AANVRAAG:	SCHAAL:	GETEKEND: MN	LEVERWEEK:	1.2a P.94
-----------	---------	-----------------	------------	-----------

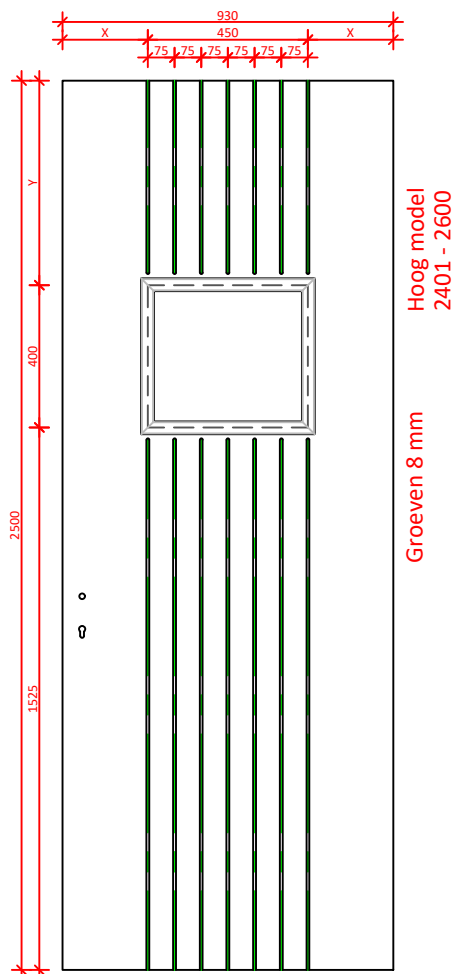
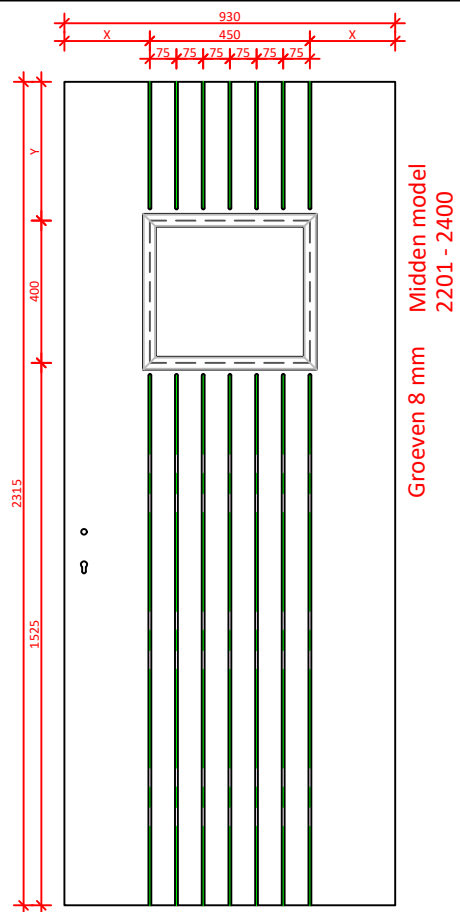
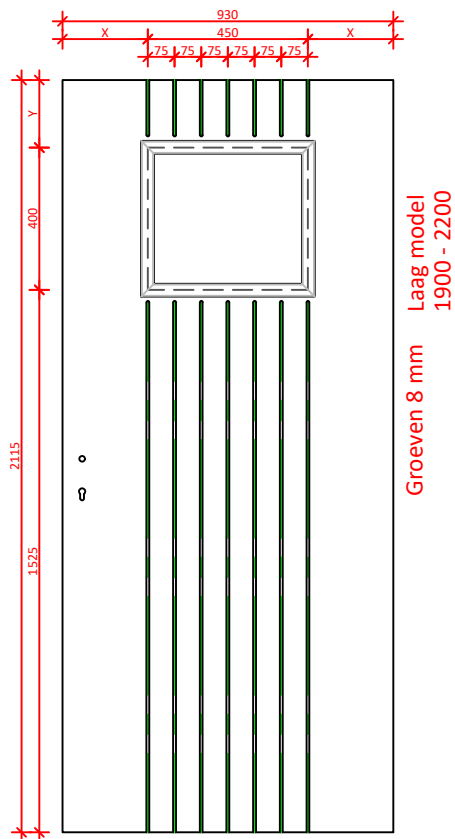

DATUM:	GEWIJZIGD:	CALCULATIENR:	TEKENINGNR:	MODEL: 9848N	HOUTSOORT:
--------	------------	---------------	-------------	-----------------	------------

	KLANT/PROJECT: overzicht modellen 9848N briefsleuf			DCM NUMMER:
--	---	--	--	-------------

AANVRAAG:	SCHAAL:	GETEKEND: MN	LEVERWEEK: 1.2a P.95
-----------	---------	-----------------	-------------------------

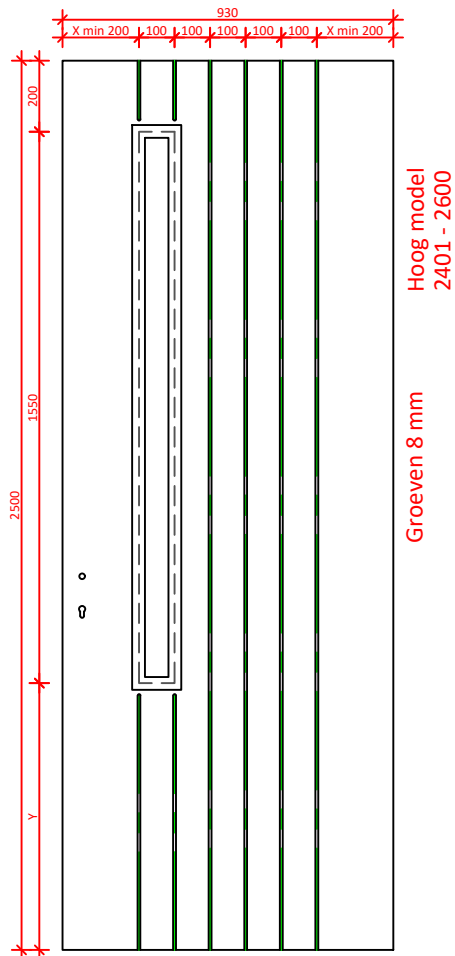
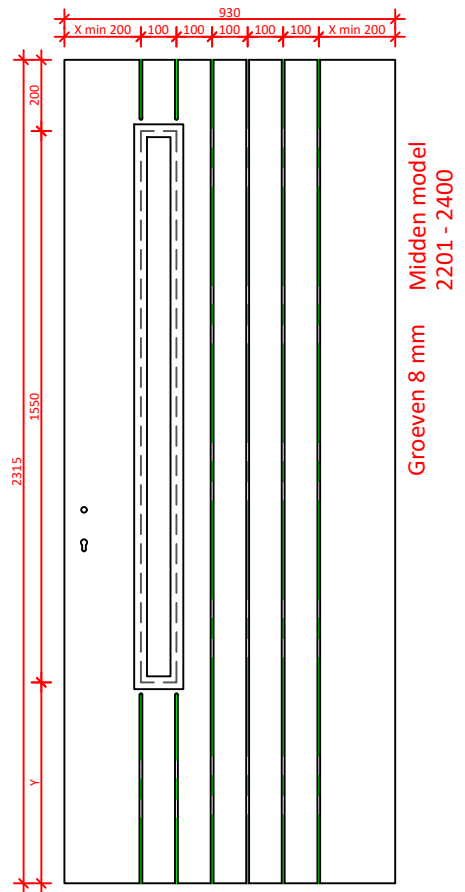
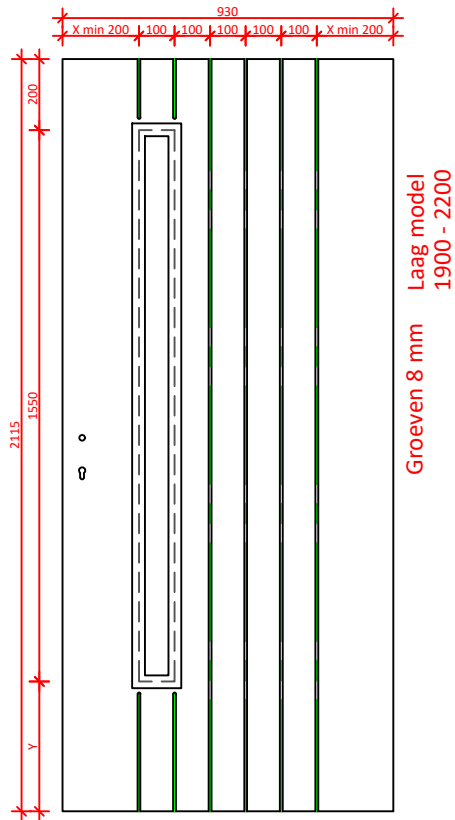

DATUM:	GEWIJZIGD:	CALCULATIENR:	TEKENINGNR:	MODEL: 9849N	HOUTSOORT:
--------	------------	---------------	-------------	-----------------	------------

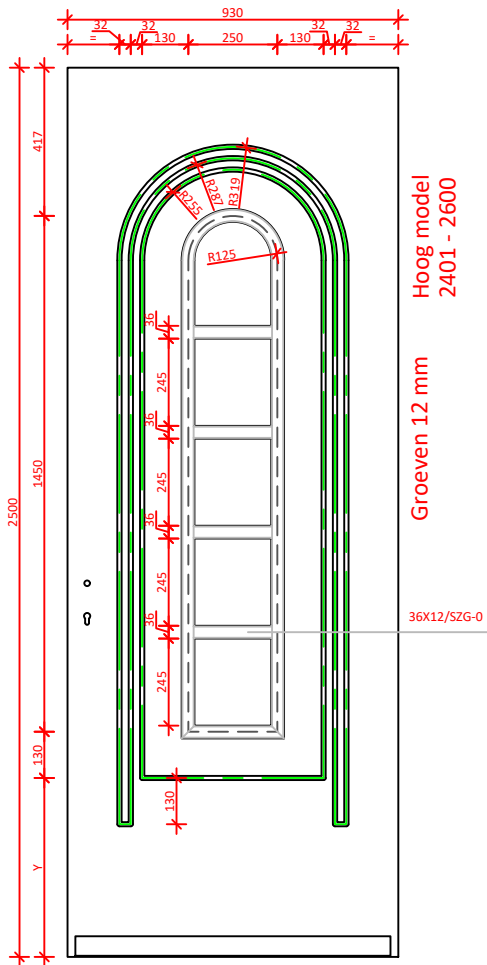
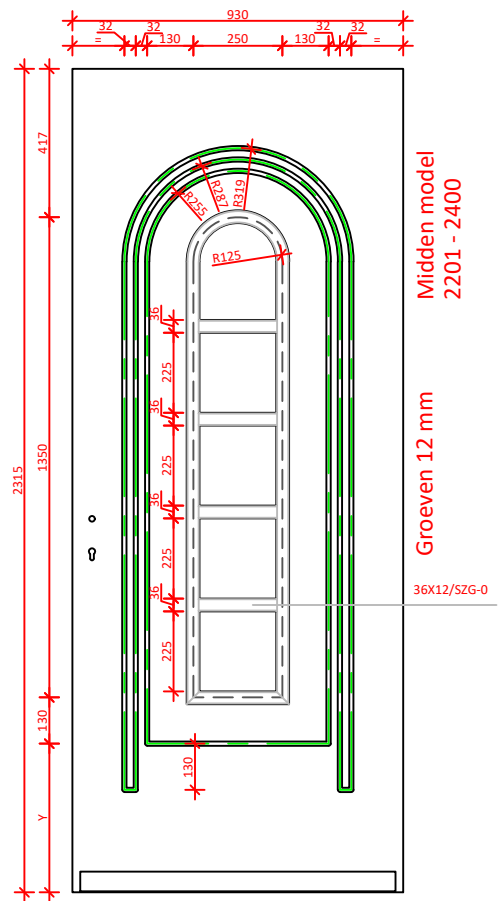
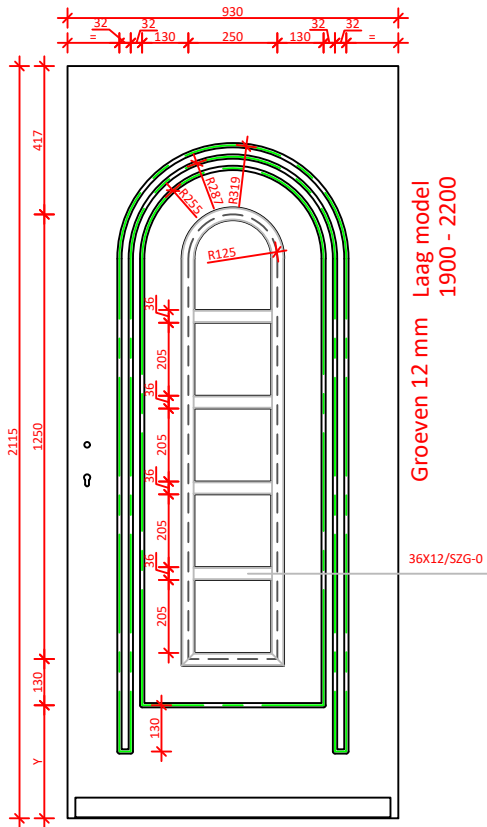

DATUM:	GEWIJZIGD:	CALCULATIENR:	TEKENINGNR: 9860N	MODEL: 9860N	HOUTSOORT:
--------	------------	---------------	----------------------	-----------------	------------

	KLANT/PROJECT: overzicht modellen 9860N briefsleuf			DCM NUMMER:
--	---	--	--	-------------

AANVRAAG:	SCHAAL:	GETEKEND: MN	LEVERWEEK:	1.2a P.97
-----------	---------	-----------------	------------	-----------

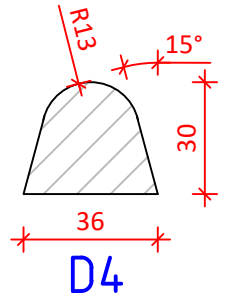
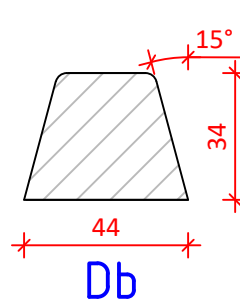
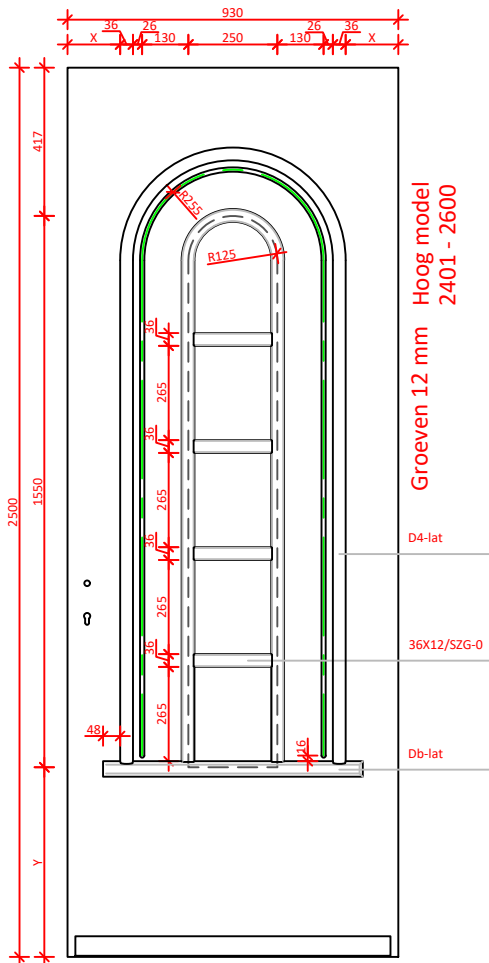
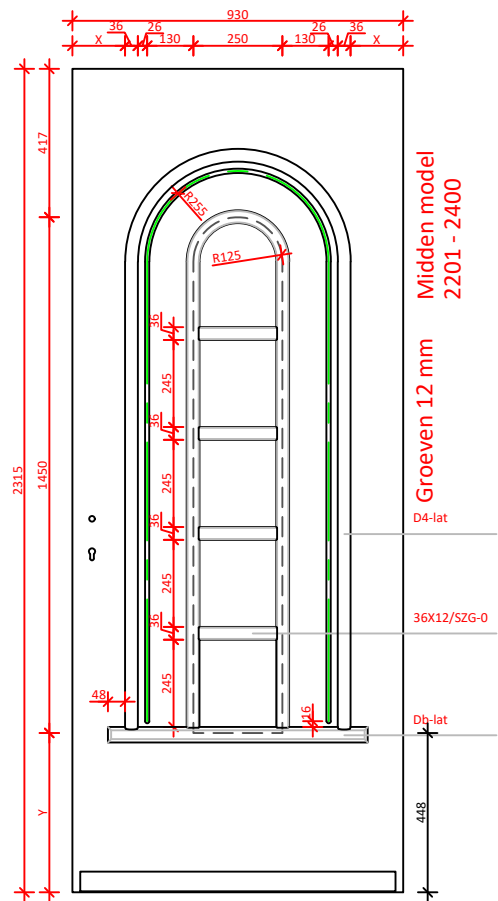
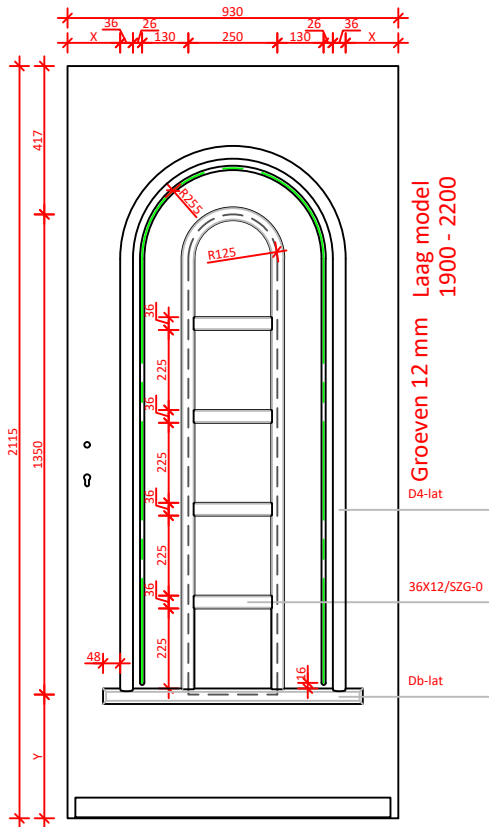

DATUM:	GEWIJZIGD:	CALCULATIENR:	TEKENINGNR:	MODEL: 9861N	HOUTSOORT:
--------	------------	---------------	-------------	-----------------	------------

	KLANT/PROJECT: overzicht modellen 9861N			DCM NUMMER:
--	--	--	--	-------------

AANVRAAG:	SCHAAL:	GETEKEND: MN	LEVERWEEK:	1.2a P.98
-----------	---------	-----------------	------------	-----------

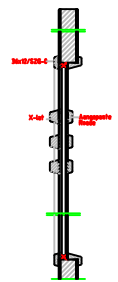
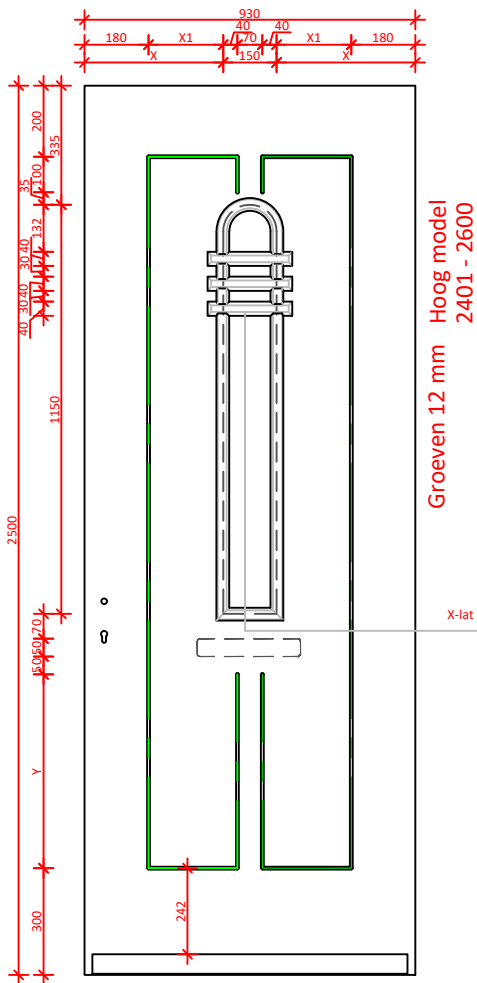
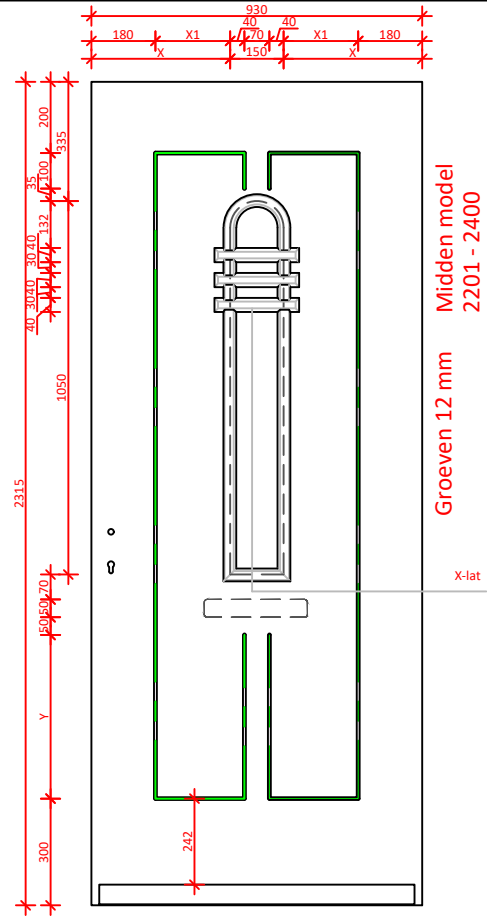
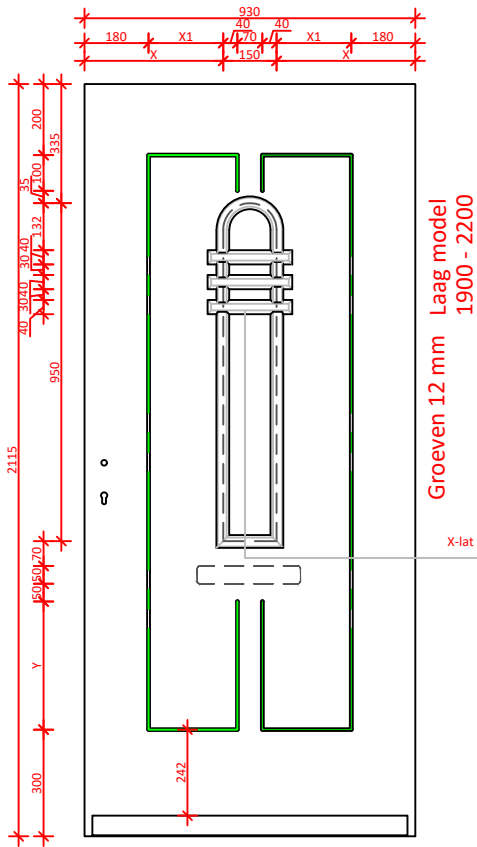

DATUM:	GEWIJZIGD:	CALCULATIENR:	TEKENINGNR:	MODEL: 9862N	HOUTSOORT:
--------	------------	---------------	-------------	-----------------	------------

	KLANT/PROJECT: overzicht modellen 9862N briefsleuf			DCM NUMMER:
--	---	--	--	-------------

AANVRAAG:	SCHAAL:	GETEKEND: MN	LEVERWEEK: 1.2a P.99
-----------	---------	-----------------	-------------------------

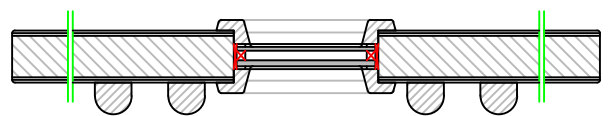
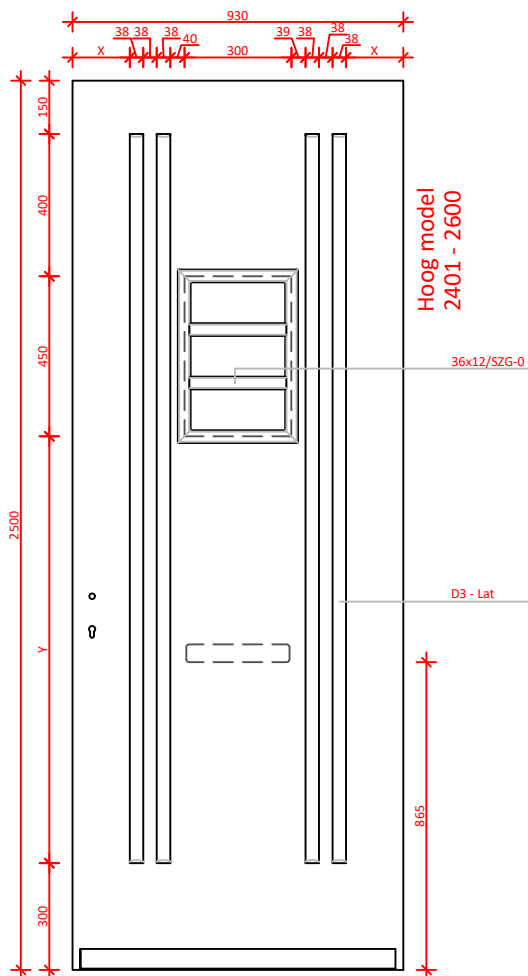
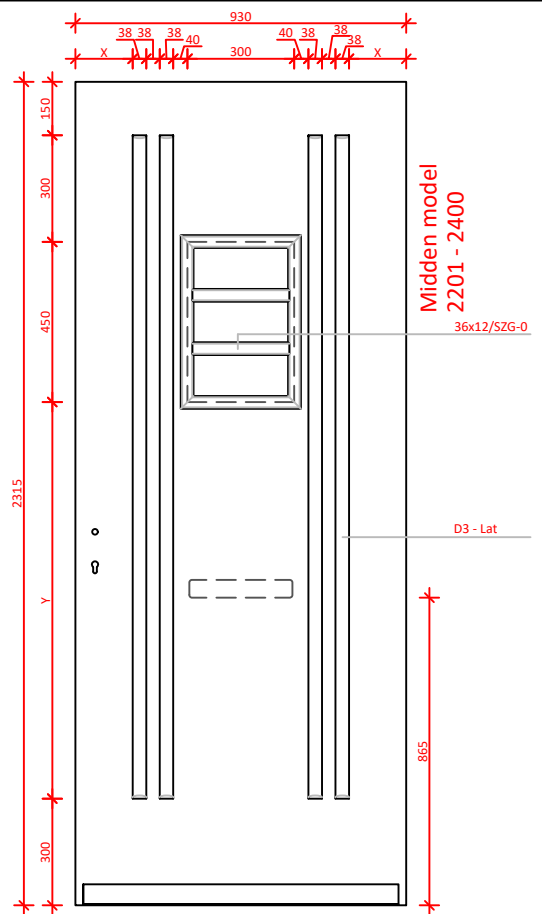
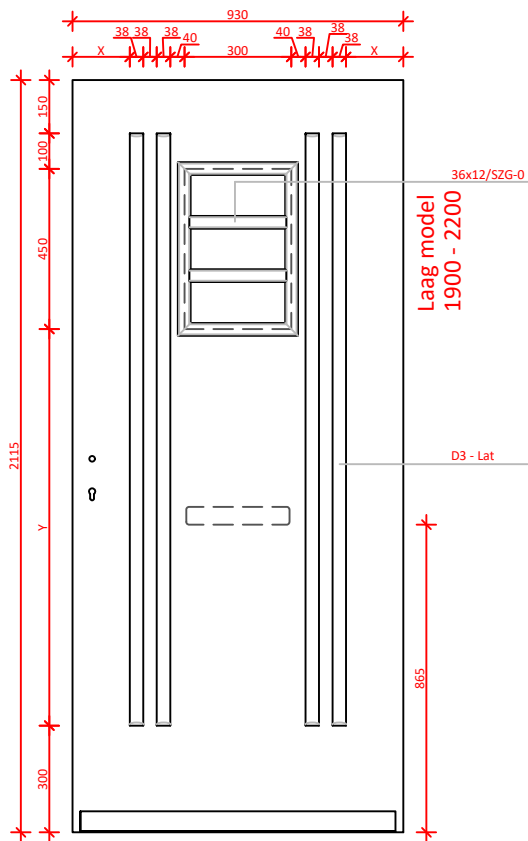

DATUM:	GEWIJZIGD:	CALCULATIENR:	TEKENINGNR:	MODEL: 9863N	HOUTSOORT:
--------	------------	---------------	-------------	-----------------	------------

	KLANT/PROJECT: overzicht modellen 9863N			DCM NUMMER:
--	--	--	--	-------------

AANVRAAG:	SCHAAL:	GETEKEND: MN	LEVERWEEK: 1.2a P.100
-----------	---------	-----------------	--------------------------



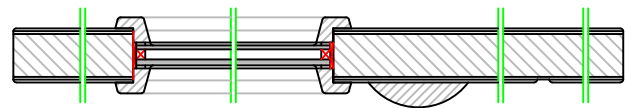
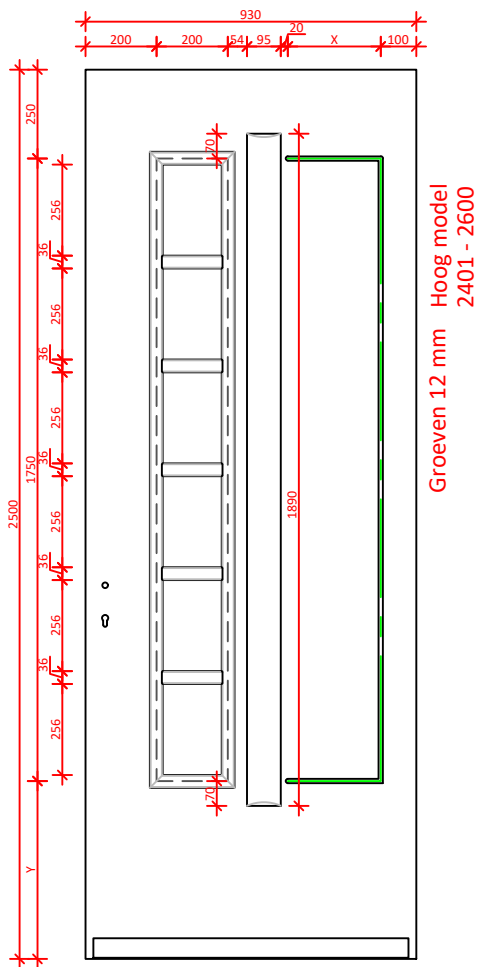
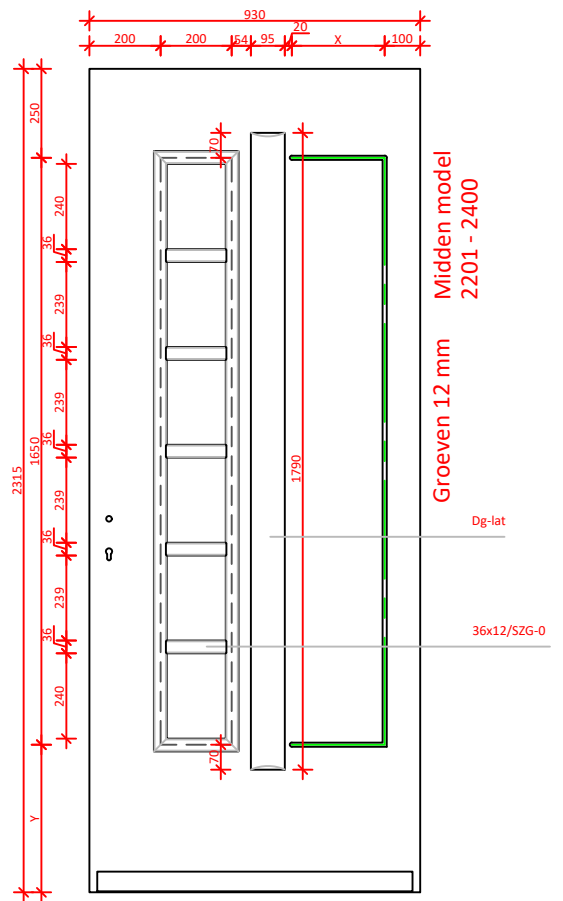
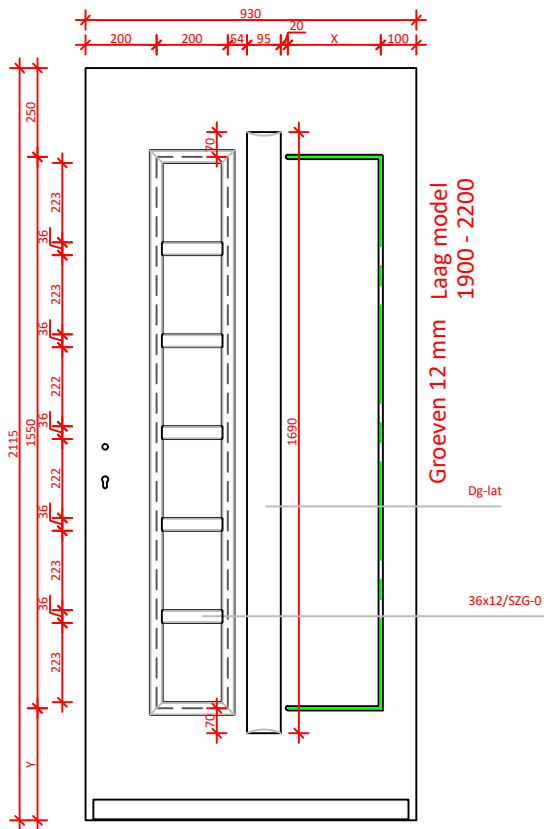

DATUM:	GEWIJZIGD:	CALCULATIENR:	TEKENINGNR:	MODEL: 9864N	HOUTSOORT:
--------	------------	---------------	-------------	-----------------	------------

	KLANT/PROJECT: overzicht modellen 9864N			DCM NUMMER:
--	--	--	--	-------------

AANVRAAG:	SCHAAL:	GETEKEND: MN	LEVERWEEK: 1.2a P.101
-----------	---------	-----------------	--------------------------

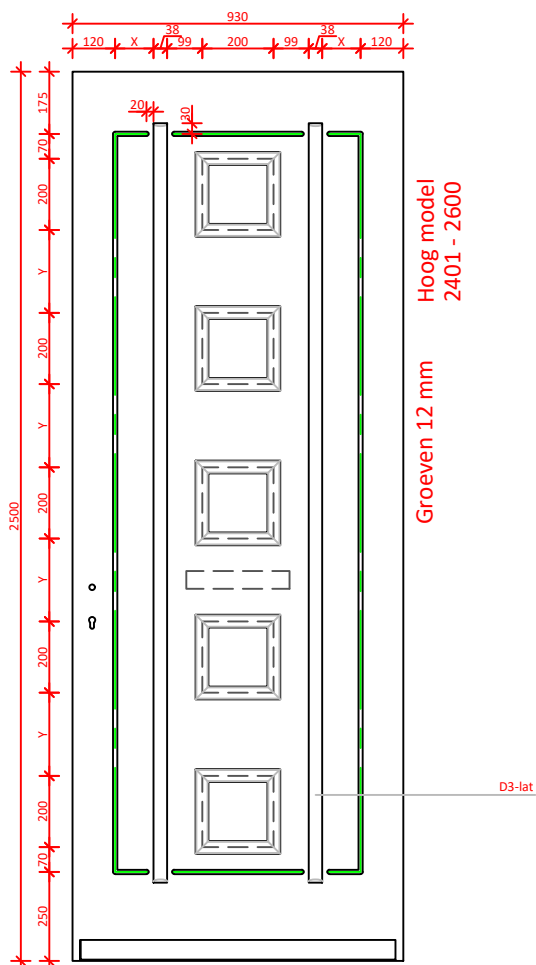
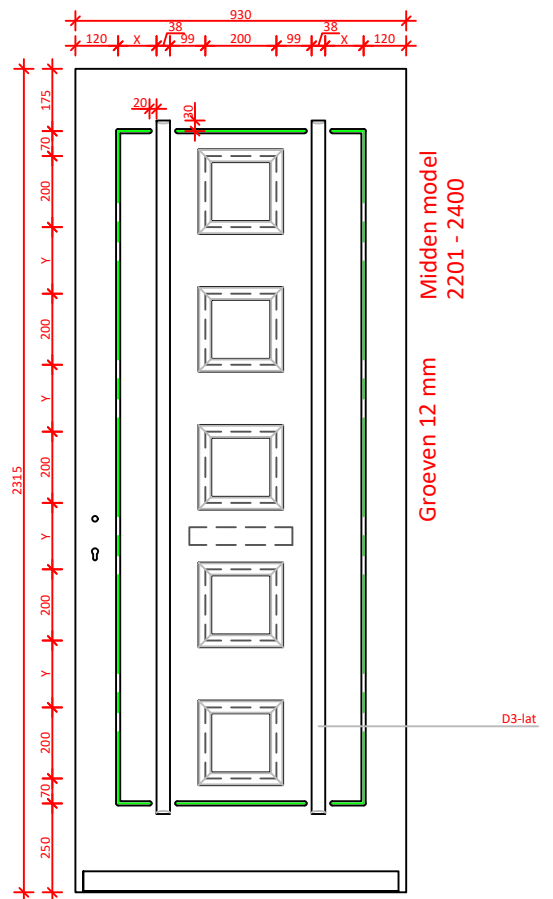
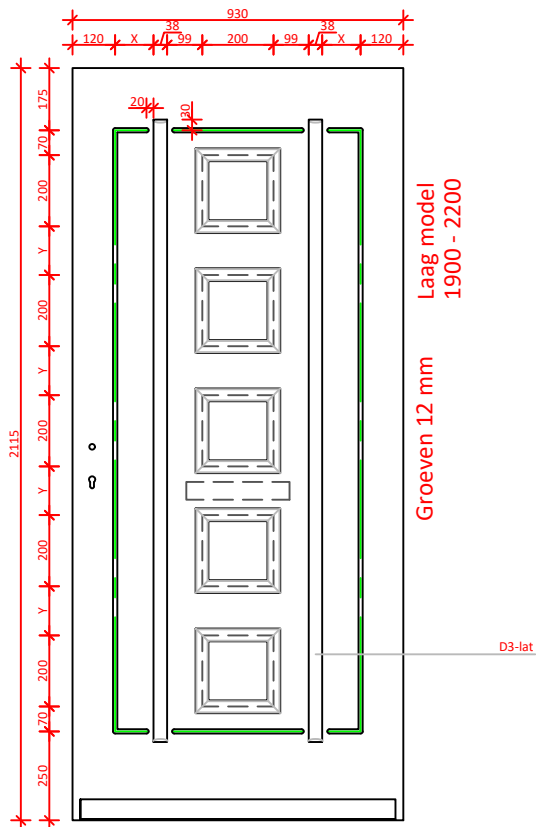

DATUM:	GEWIJZIGD:	CALCULATIENR:	TEKENINGNR:	MODEL: 9865N	HOUTSOORT:
--------	------------	---------------	-------------	-----------------	------------

	KLANT/PROJECT: overzicht modellen 9865N			DCM NUMMER:
--	--	--	--	-------------

AANVRAAG:	SCHAAL:	GETEKEND: MN	LEVERWEEK: 1.2a P.102
-----------	---------	-----------------	--------------------------

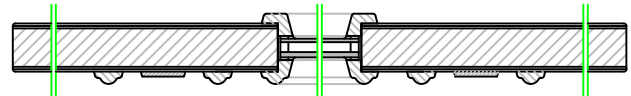
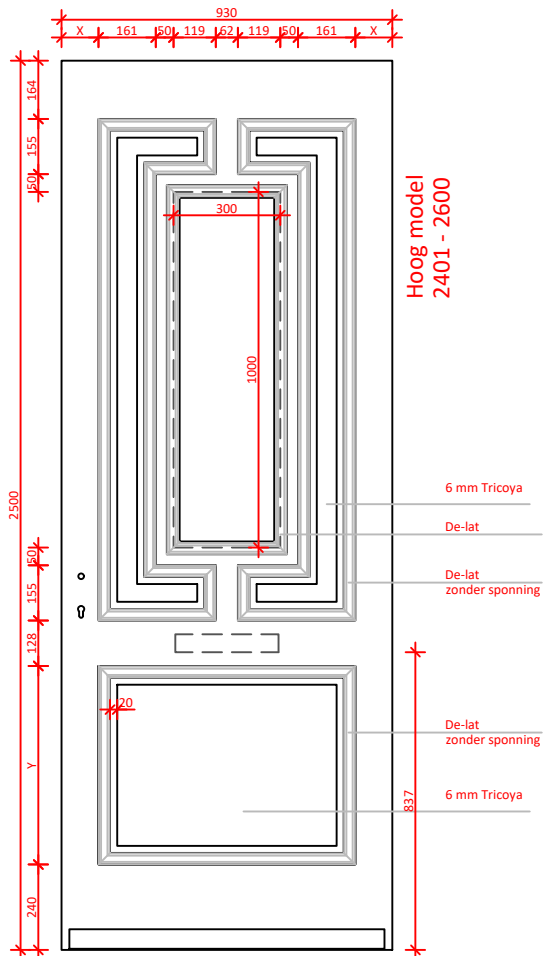
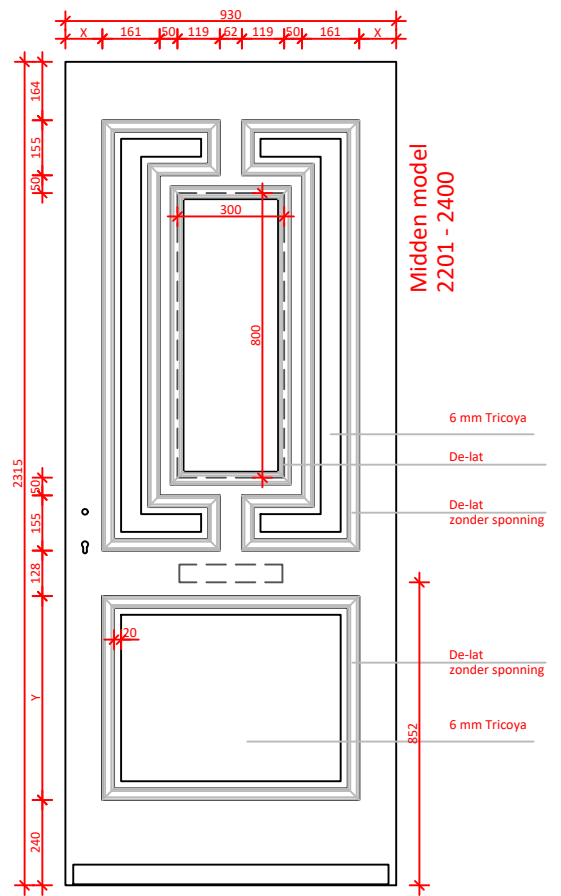
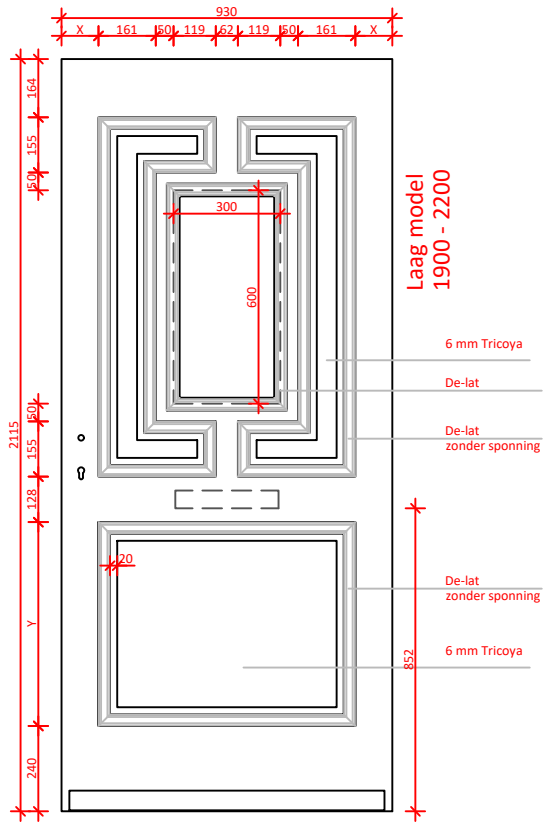

DATUM:	GEWIJZIGD:	CALCULATIENR:	TEKENINGNR: 9866N	MODEL: 9866N	HOUTSOORT:
--------	------------	---------------	----------------------	-----------------	------------

<b>KEGRO   DEUREN</b>	KLANT/PROJECT: overzicht modellen 9866N			DCM NUMMER:
-----------------------	--	--	--	-------------

AANVRAAG:	SCHAAL:	GETEKEND: MN	LEVERWEEK: 1.2a P.103
-----------	---------	-----------------	--------------------------

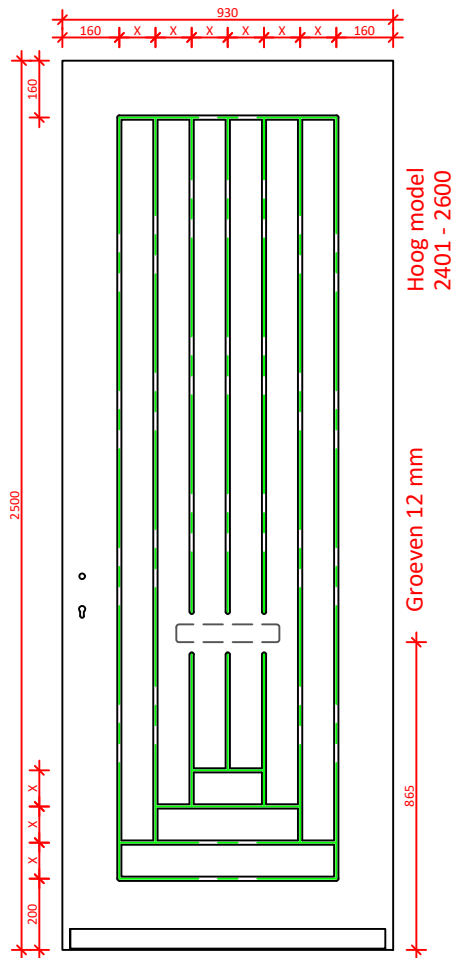
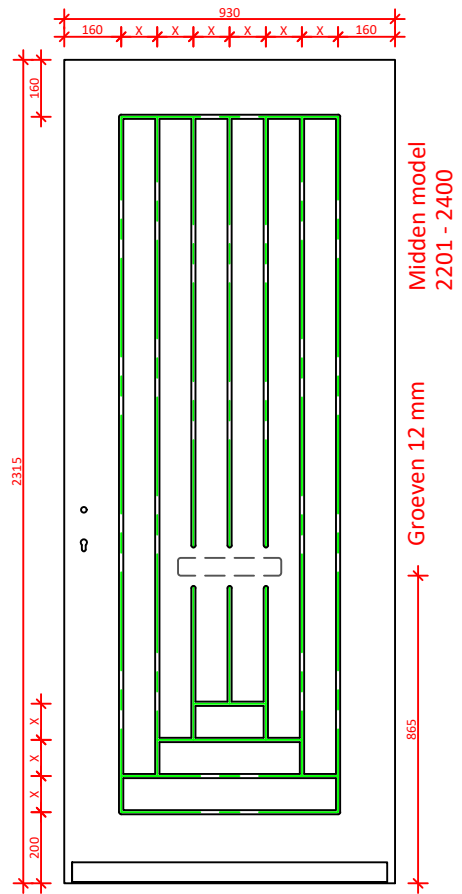
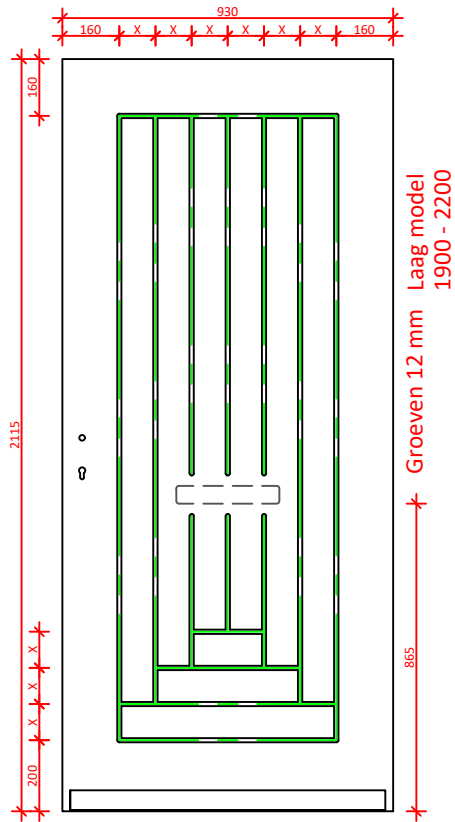

DATUM:	GEWIJZIGD:	CALCULATIENR:	TEKENINGNR:	MODEL: 9867	HOUTSOORT:
--------	------------	---------------	-------------	----------------	------------

	KLANT/PROJECT: overzicht modellen 9867 met briefsleuf			DCM NUMMER:
--	--	--	--	-------------

AANVRAAG:	SCHAAL:	GETEKEND: MN	LEVERWEEK: 1.2a P.104
-----------	---------	-----------------	--------------------------

dé makers van buitendeuren

BEZOEKADRES  
Industrieweg 25  
6562 AP Groesbeek  
+31 (0)24 399 95 55  
info@kegro.nl  
www.kegro.nl

SOCIAL MEDIA  
 KegroDeuren  
 @kegrodeuren  
 kegro-Deuren

**KEGRO** | DEUREN