

1.2A Deuropbouw en maatvoering Vlakke Deuren

Kegro Deuren hanteert 1 modelnummer voor de afmetingen hoog, midden en laag. De Glasmaat staat hierbij vast.

Uitvoering in 3 hoogtes:

- <2200mm = Laag model
- 2201 – 2400mm = Midden model
- >2401mm = Hoog model
- De minimale maat is veelal 1900mm

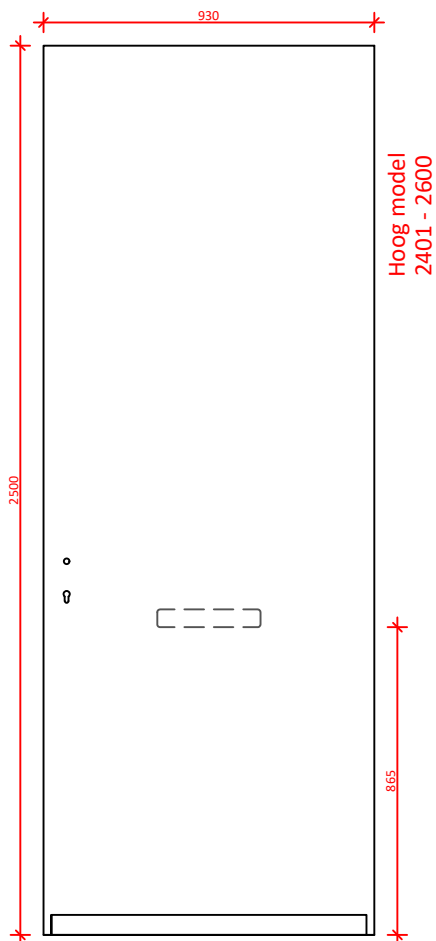
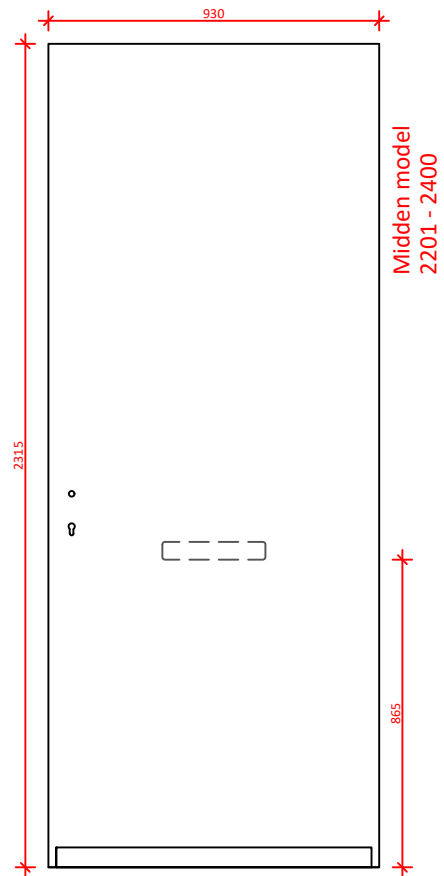
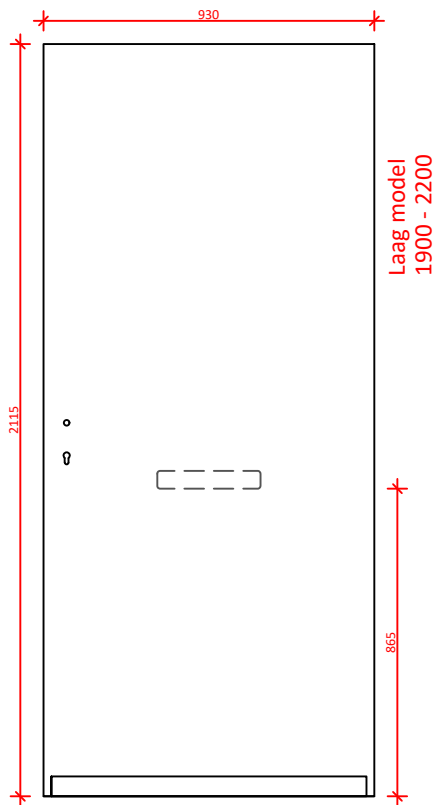

DATUM:	GEWIJZIGD:	CALCULATIENR:	TEKENINGNR: 9101	MODEL:	HOUTSOORT:
--------	------------	---------------	---------------------	--------	------------

KEGRO DEUREN	KLANT/PROJECT: overzicht modellen 9101 L1 - R4			DCM NUMMER:	
-----------------------	---	--	--	-------------	--

AANVRAAG:	SCHAAL:	GETEKEND: MN	LEVERWEEK:	1.2a P.2
-----------	---------	-----------------	------------	----------

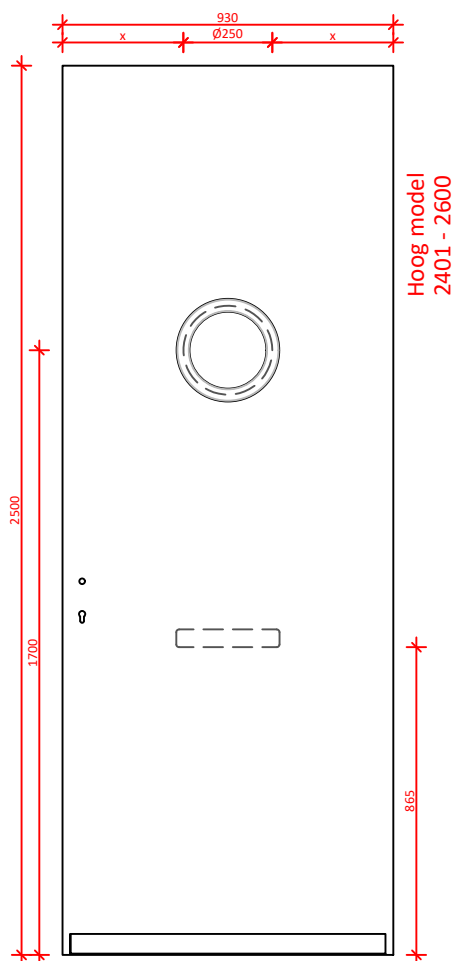
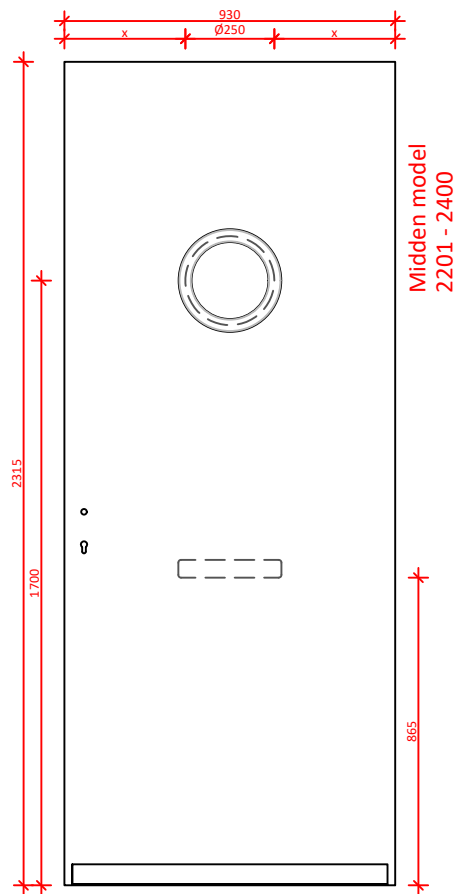
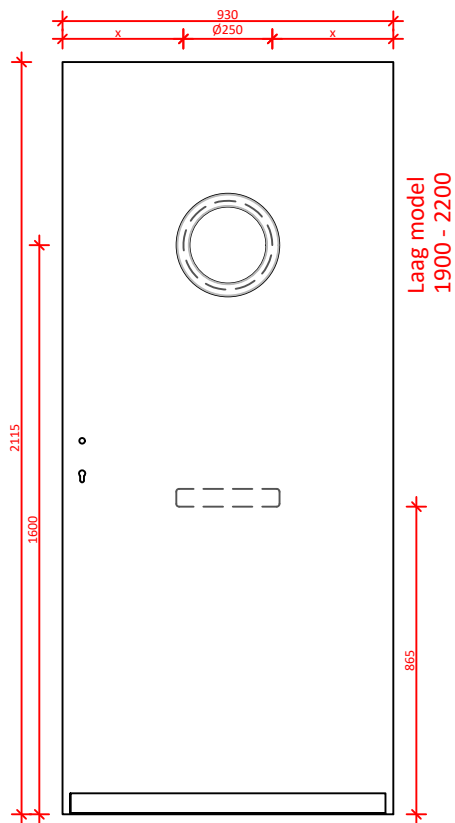

DATUM:	GEWIJZIGD:	CALCULATIENR:	TEKENINGNR:	MODEL: 9152N	HOUTSOORT:
--------	------------	---------------	-------------	-----------------	------------

	KLANT/PROJECT: overzicht modellen 9152N			DCM NUMMER:
--	--	--	--	-------------

AANVRAAG:	SCHAAL:	GETEKEND:	LEVERWEEK:	1.2a P.3
-----------	---------	-----------	------------	----------

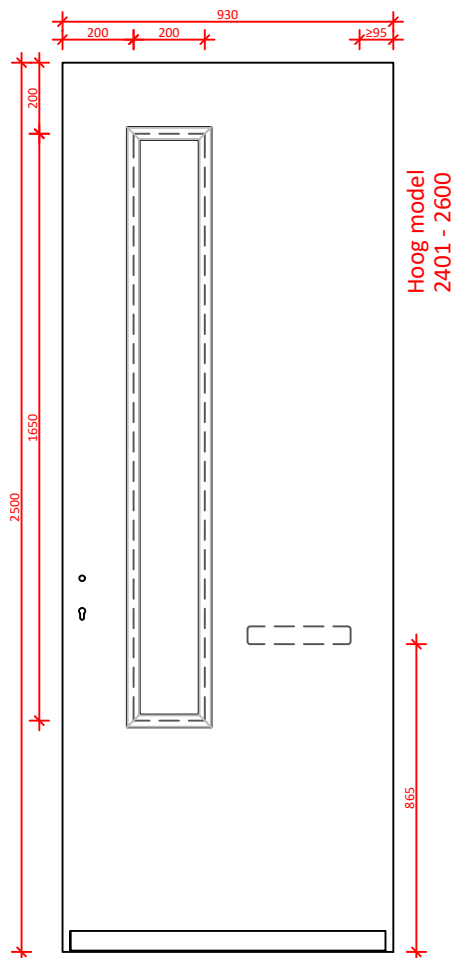
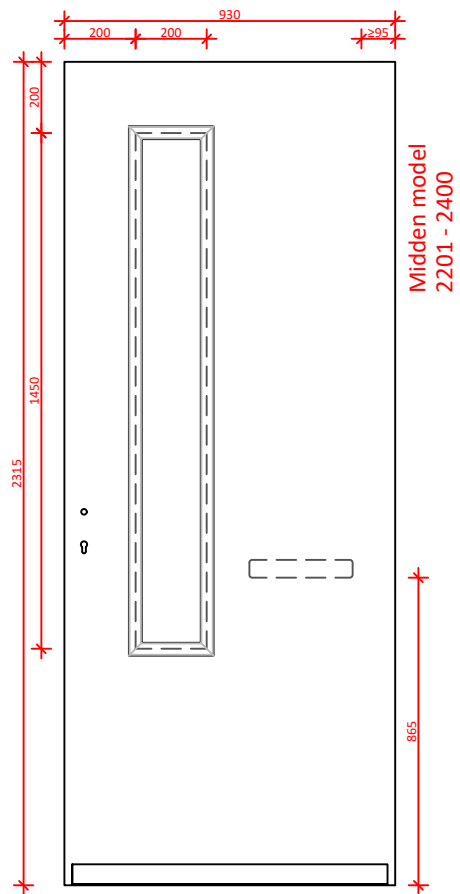
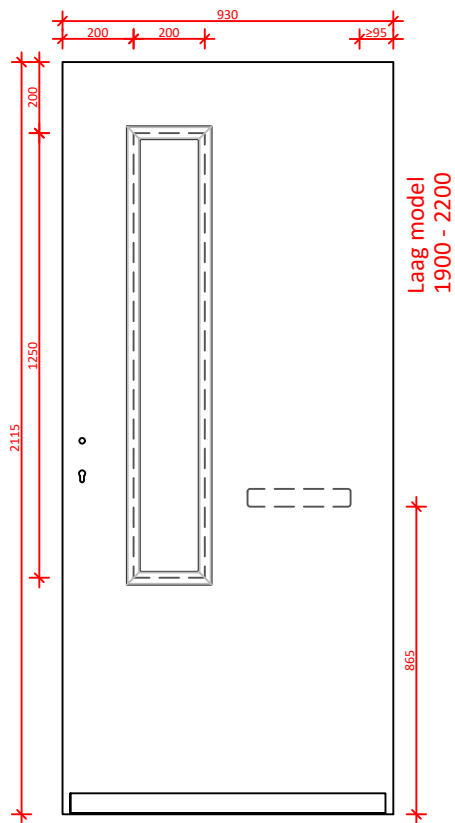

DATUM:	GEWIJZIGD:	CALCULATIENR:	TEKENINGNR:	MODEL: 9153N	HOUTSOORT:
--------	------------	---------------	-------------	-----------------	------------

	KLANT/PROJECT: overzicht modellen 9153N L1 - R4			DCM NUMMER:
--	--	--	--	-------------

AANVRAAG:	SCHAAL:	GETEKEND: MN	LEVERWEEK:	1.2a P.4
-----------	---------	-----------------	------------	----------

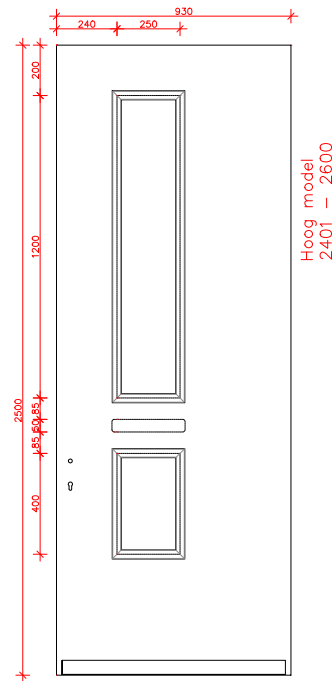
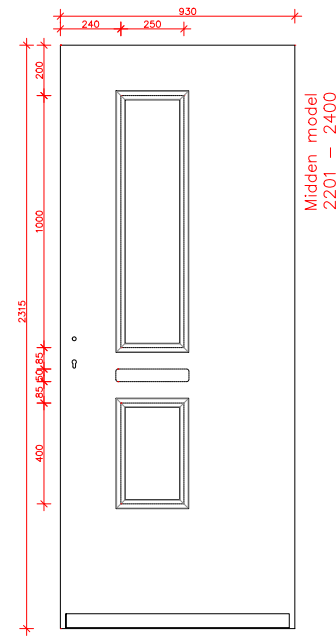
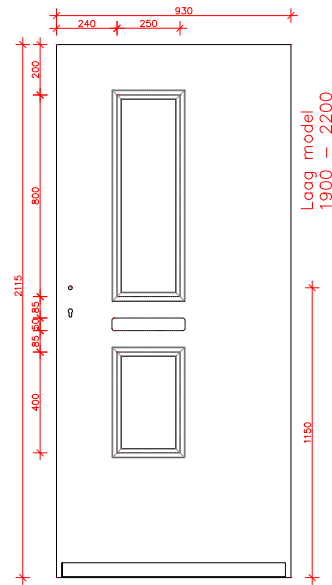

DATUM:	GEWIJZIGD:	CALCULATIENR:	TEKENINGNR: 9154N	MODEL: 9154N	HOUTSOORT:
			KLANT/PROJECT: overzicht modellen 9154N L1 - R4		DCM NUMMER:
			AANVRAAG:	SCHAAL:	GETEKEND: MN

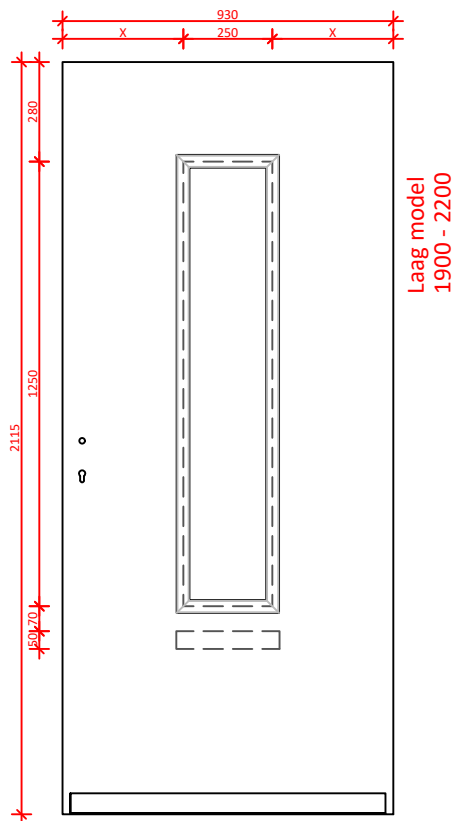

LET OP!! briefsleuf niet vlgs PostNI norm.

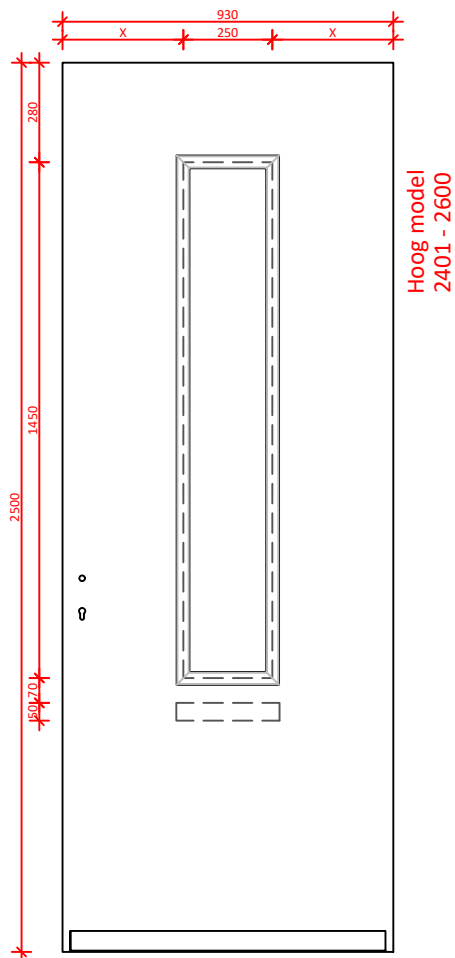
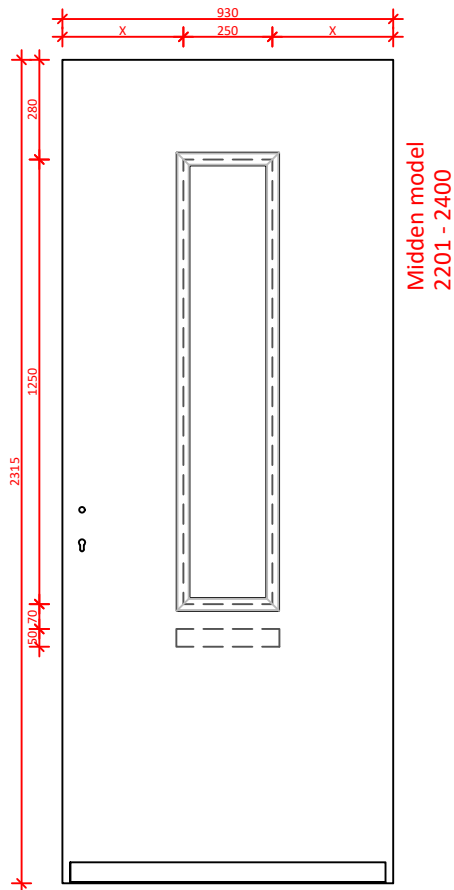

DATUM:	GEWIJZIGD:	CALCULATIENR:	TEKENINGNR: 9155N	MODEL:	HOUTSOORT:
--------	------------	---------------	----------------------	--------	------------

	KLANT/PROJECT: overzicht modellen 9155N			DCM NUMMER:
--	--	--	--	-------------

AANVRAAG:	SCHAAL:	GETEKEND: MN	LEVERWEEK:	1.2a P.6
-----------	---------	-----------------	------------	----------

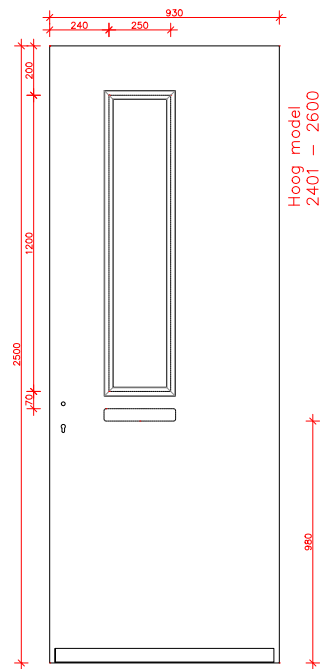
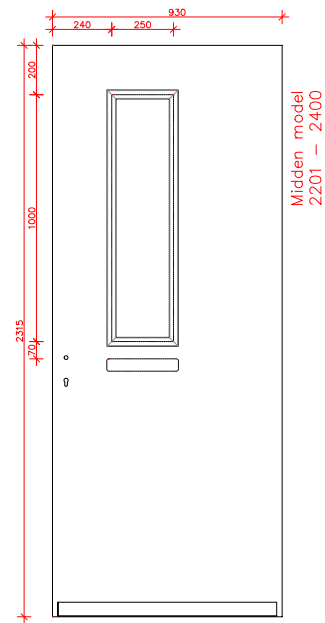
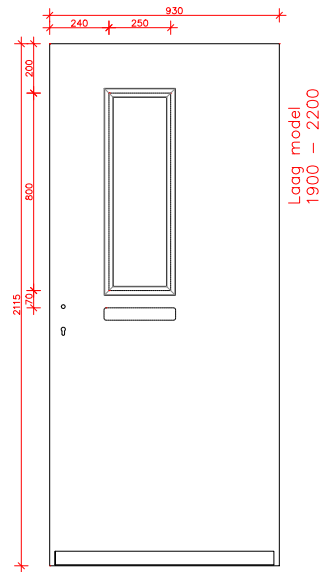

DATUM:	GEWIJZIGD:	CALCULATIENR:	TEKENINGNR: 9156N	MODEL: 9156N	HOUTSOORT:
			KLANT/PROJECT: overzicht modellen 9156N		DCM NUMMER:
			AANVRAAG:	SCHAAL:	GETEKEND: MN

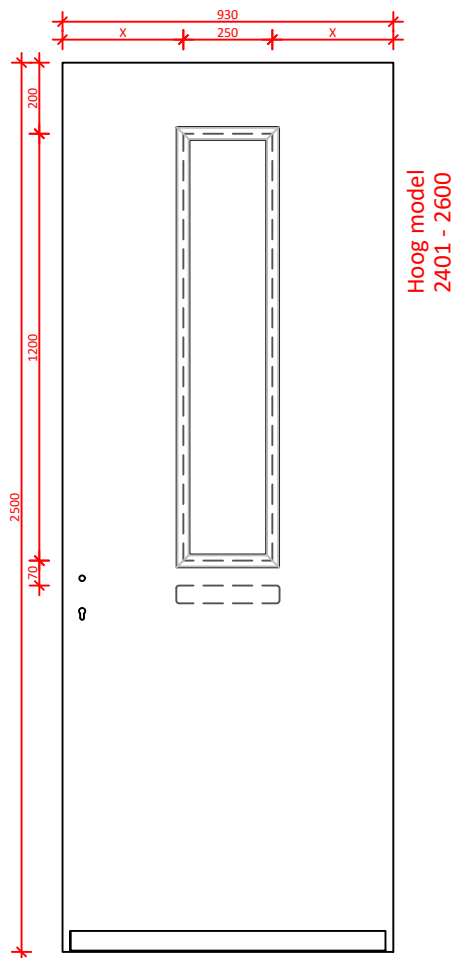
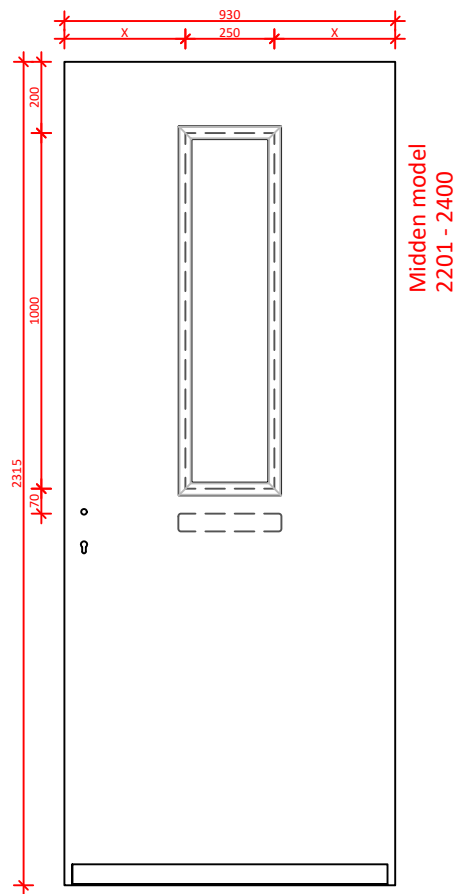
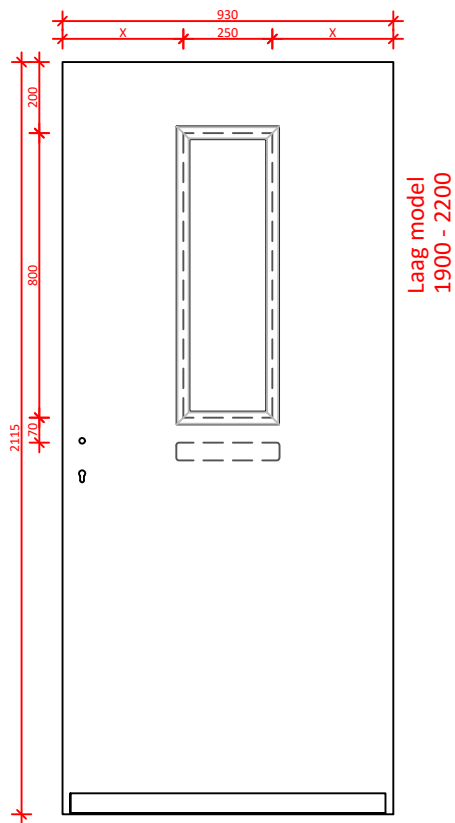

DATUM:	GEWIJZIGD:	CALCULATIENR:	TEKENINGNR: 9157N	MODEL:	HOUTSOORT:
--------	------------	---------------	----------------------	--------	------------

KEGRO DEUREN	KLANT/PROJECT: overzicht modellen 9157N			DCM NUMMER:
-----------------------	--	--	--	-------------

AANVRAAG:	SCHAAL:	GETEKEND: MN	LEVERWEEK:	1.2a P.8
-----------	---------	-----------------	------------	----------

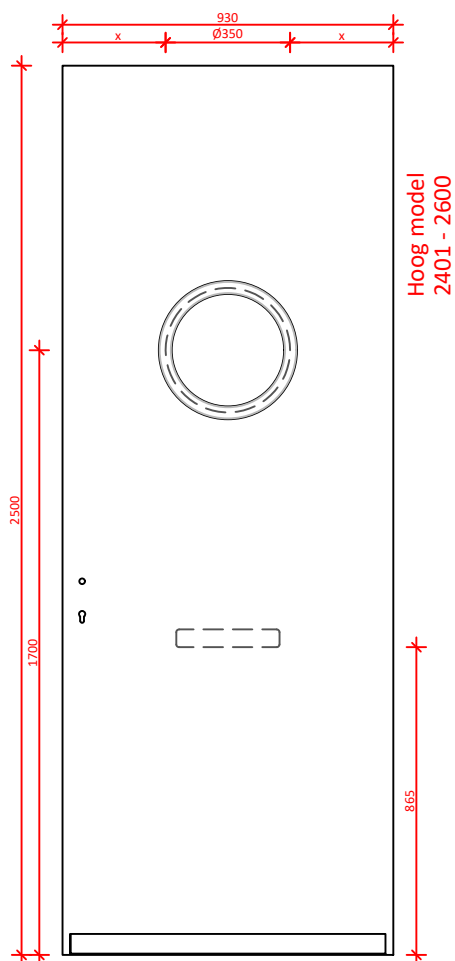
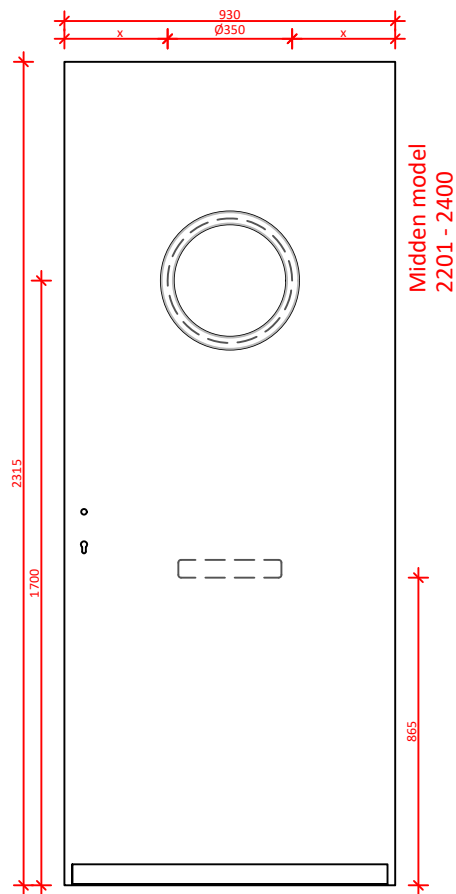
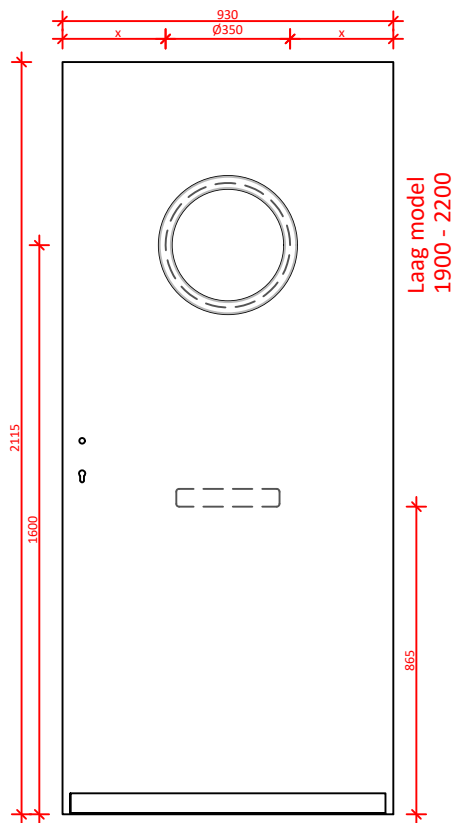

DATUM:	GEWIJZIGD:	CALCULATIENR:	TEKENINGNR: 9162N	MODEL:	HOUTSOORT:
--------	------------	---------------	----------------------	--------	------------

KEGRO DEUREN	KLANT/PROJECT: overzicht modellen 9162N			DCM NUMMER:
-----------------------	--	--	--	-------------

AANVRAAG:	SCHAAL:	GETEKEND:	LEVERWEEK:	1.2a P.9
-----------	---------	-----------	------------	----------

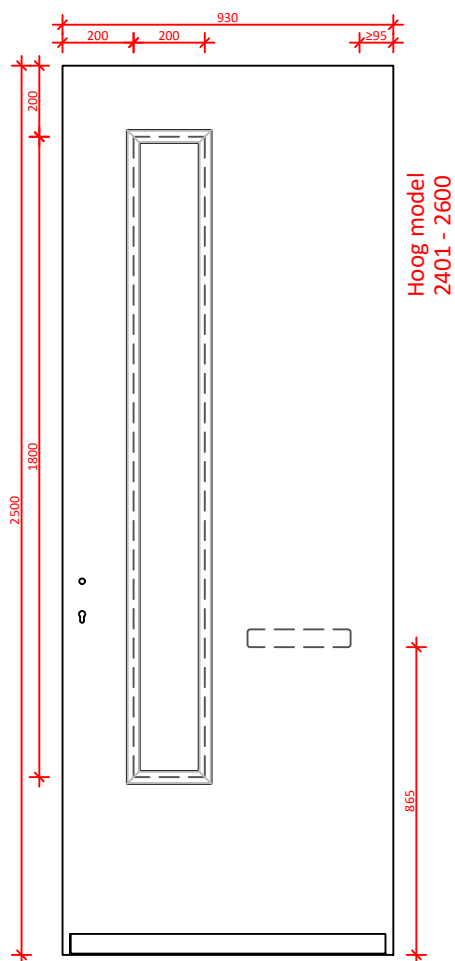
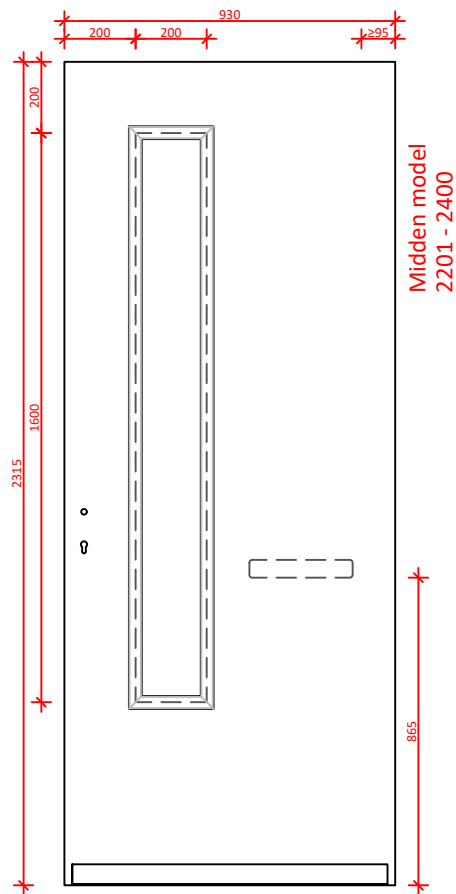
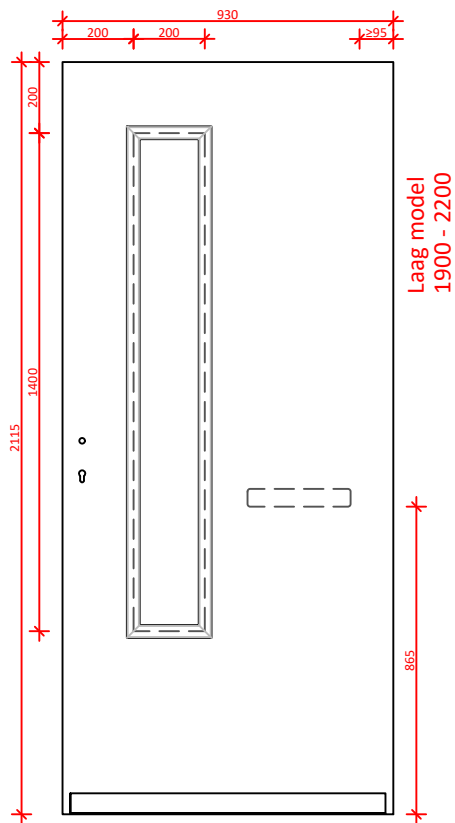

DATUM:	GEWIJZIGD:	CALCULATIENR:	TEKENINGNR: 9163N	MODEL:	HOUTSOORT:
--------	------------	---------------	----------------------	--------	------------

	KLANT/PROJECT: overzicht modellen 9163N L1 - R4			DCM NUMMER:
--	--	--	--	-------------

AANVRAAG:	SCHAAL:	GETEKEND: MN	LEVERWEEK:	1.2a P.10
-----------	---------	-----------------	------------	-----------

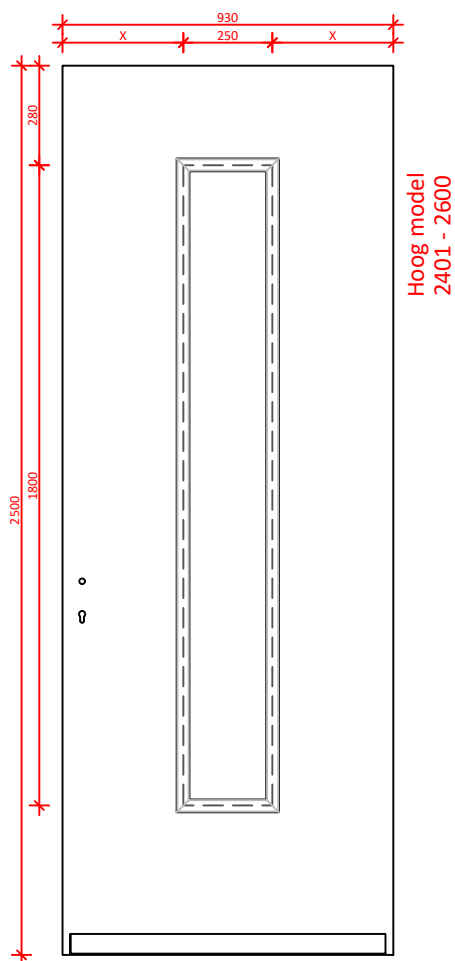
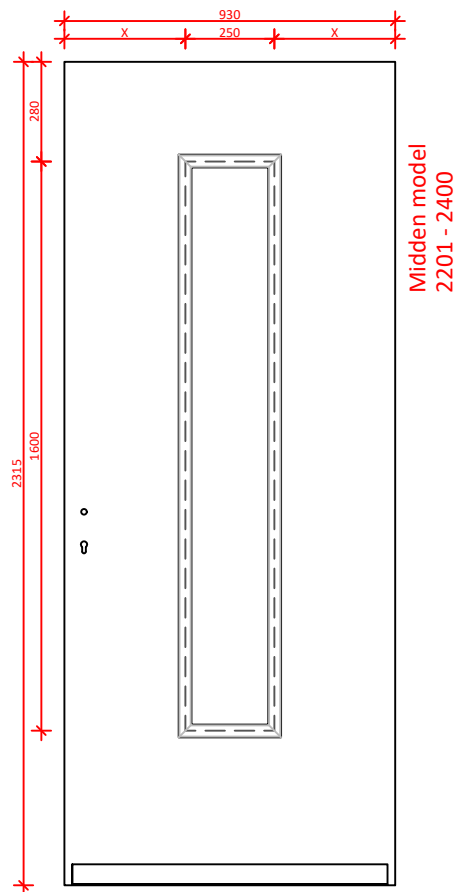
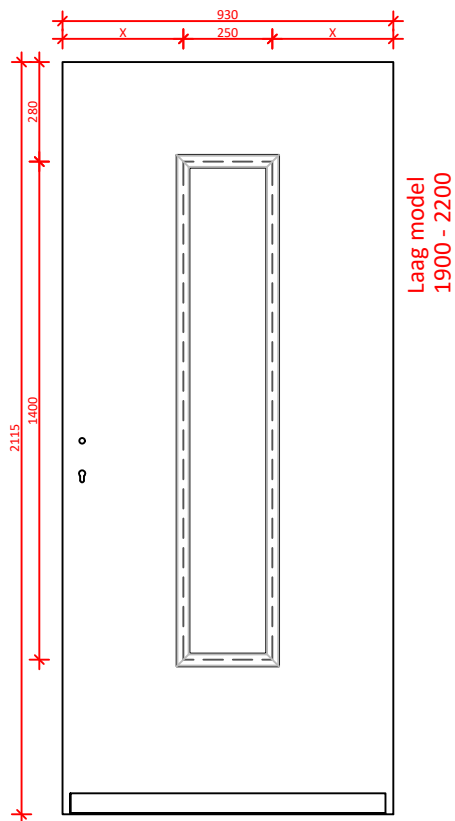

DATUM:	GEWIJZIGD:	CALCULATIENR:	TEKENINGNR: 9165N	MODEL:	HOUTSOORT:
--------	------------	---------------	----------------------	--------	------------

	KLANT/PROJECT: overzicht modellen 9165N			DCM NUMMER:
--	--	--	--	-------------

AANVRAAG:	SCHAAL:	GETEKEND: MN	LEVERWEEK:	1.2a P.11
-----------	---------	-----------------	------------	-----------

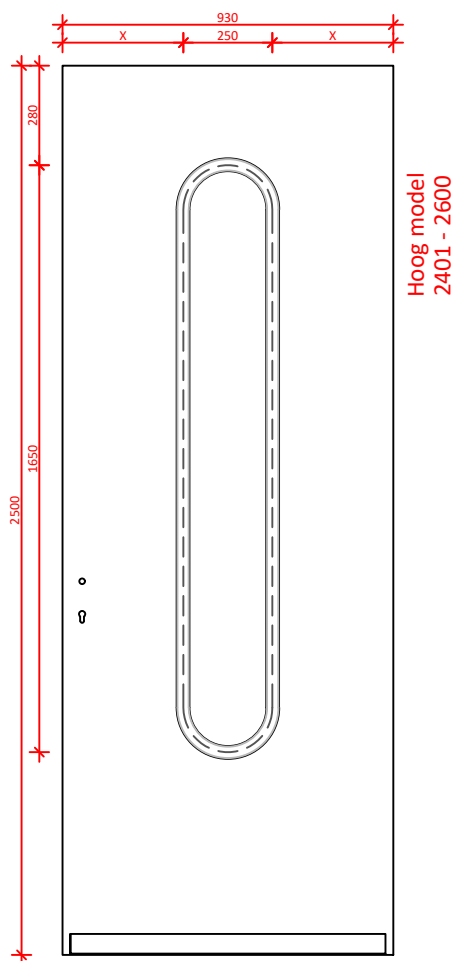
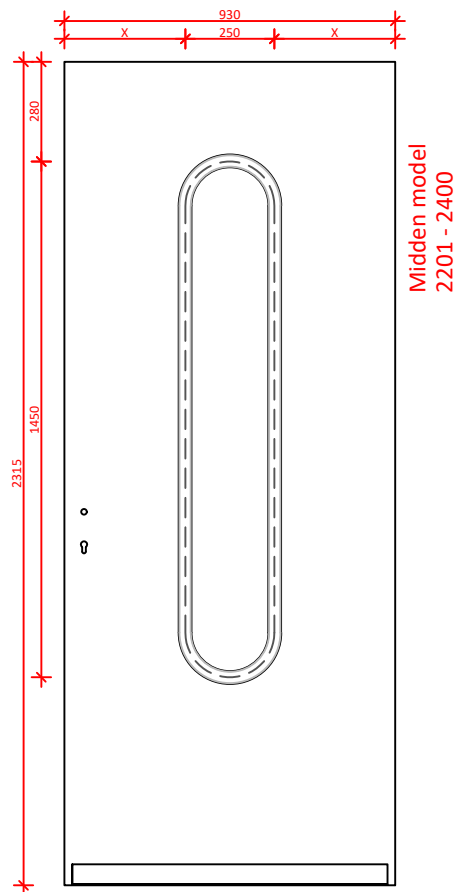
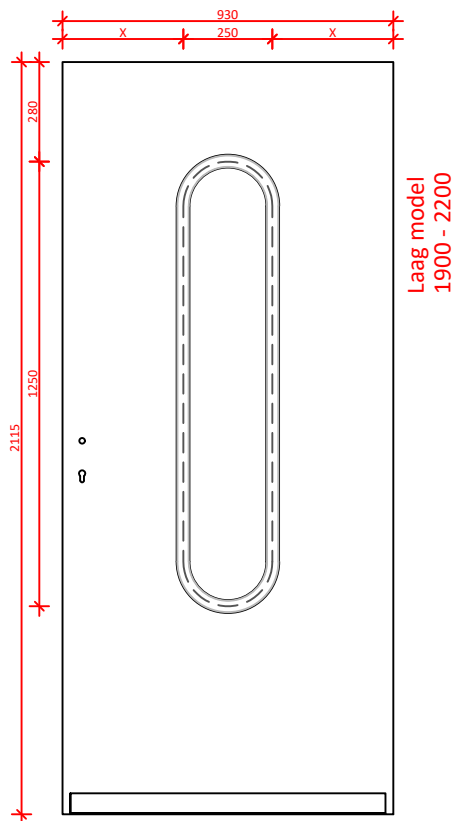

DATUM:	GEWIJZIGD:	CALCULATIENR:	TEKENINGNR: 9166N	MODEL:	HOUTSOORT:
--------	------------	---------------	----------------------	--------	------------

	KLANT/PROJECT: overzicht modellen 9166N			DCM NUMMER:
--	--	--	--	-------------

AANVRAAG:	SCHAAL:	GETEKEND: MN	LEVERWEEK:	1.2a P.12
-----------	---------	-----------------	------------	-----------

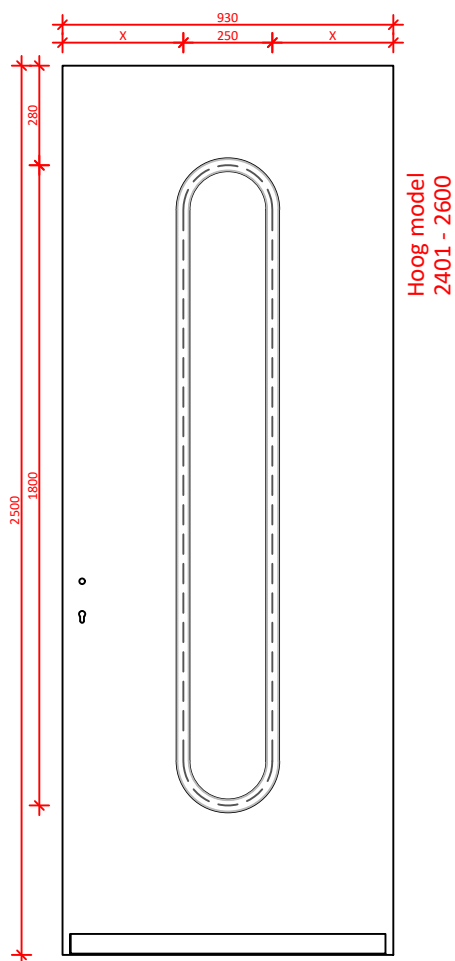
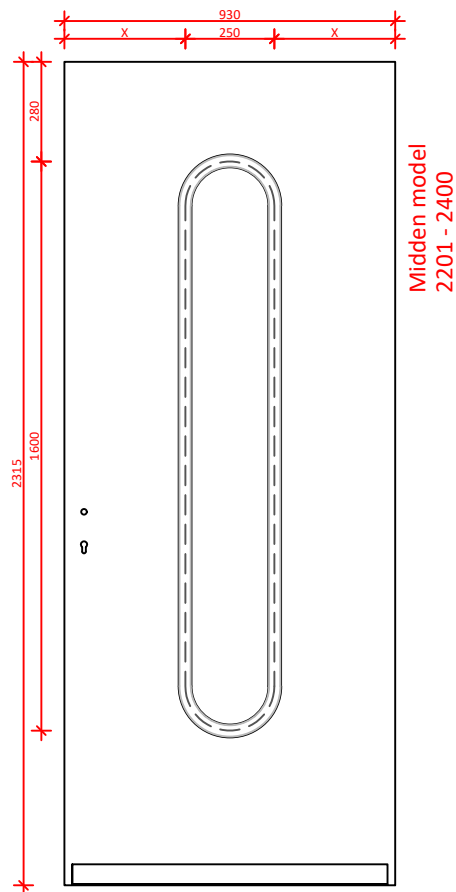
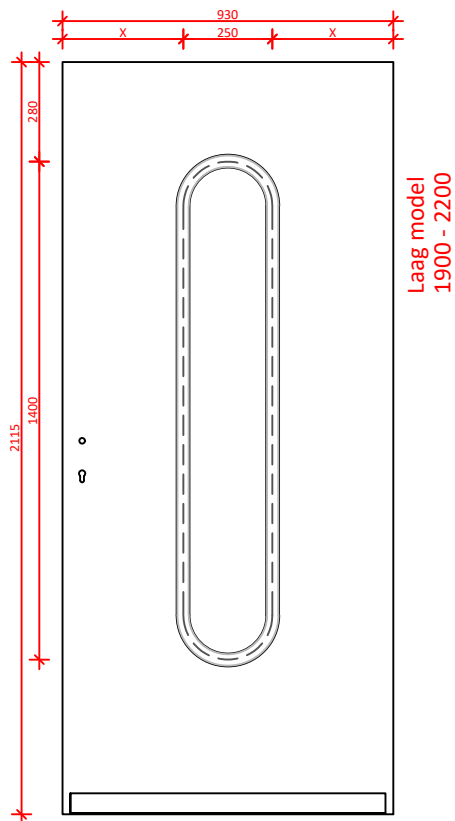

DATUM:	GEWIJZIGD:	CALCULATIENR:	TEKENINGNR: 9167N	MODEL:	HOUTSOORT:
--------	------------	---------------	----------------------	--------	------------

KEGRO DEUREN	KLANT/PROJECT: overzicht modellen 9167N			DCM NUMMER:
-----------------------	--	--	--	-------------

AANVRAAG:	SCHAAL:	GETEKEND: MN	LEVERWEEK:	1.2a P.13
-----------	---------	-----------------	------------	-----------

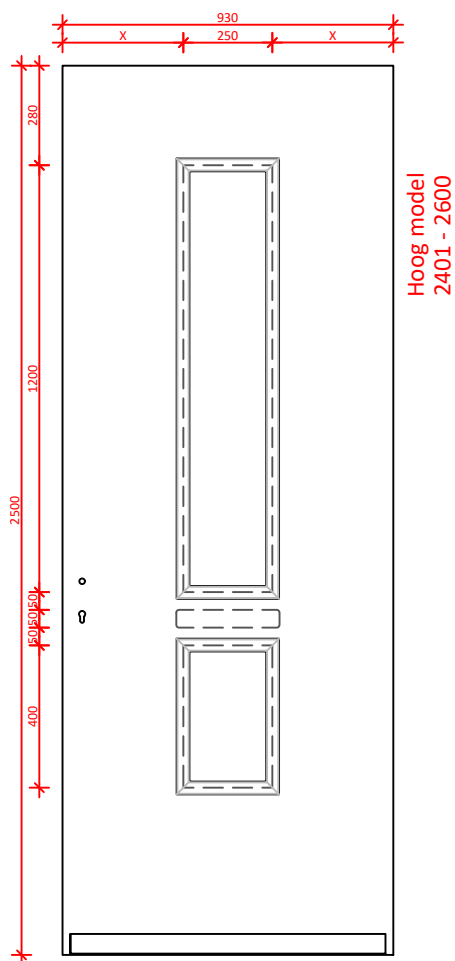
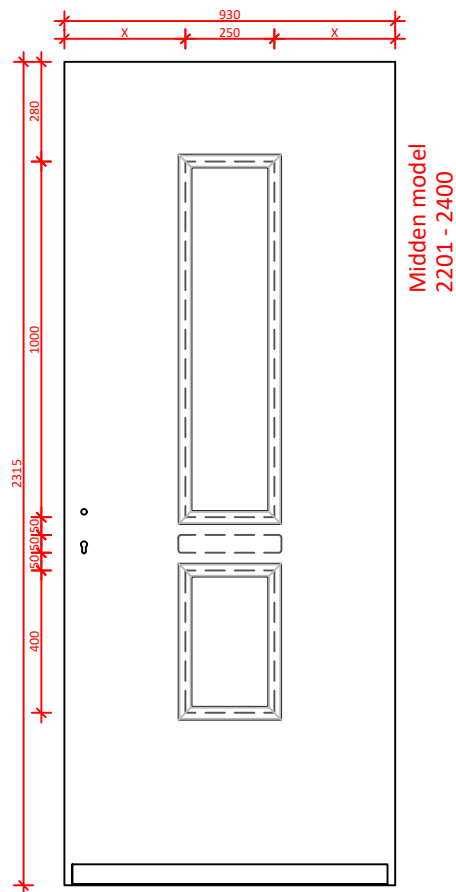
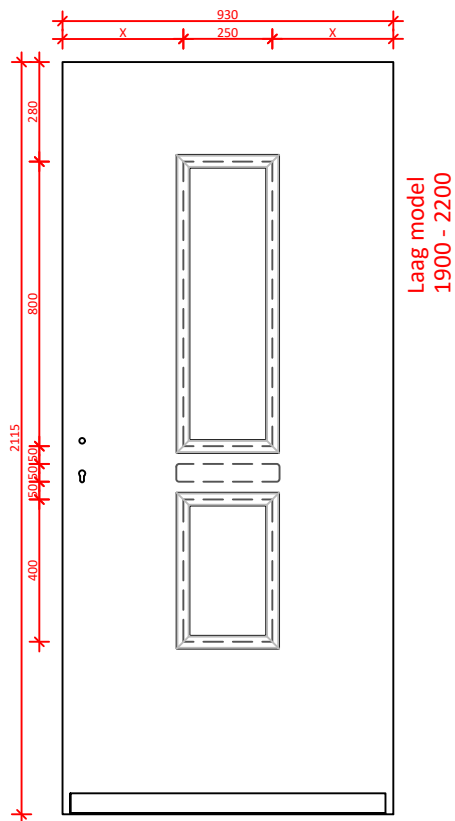

DATUM:	GEWIJZIGD:	CALCULATIENR:	TEKENINGNR: 9168N	MODEL:	HOUTSOORT:
--------	------------	---------------	----------------------	--------	------------

	KLANT/PROJECT: overzicht modellen 9168N			DCM NUMMER:
--	--	--	--	-------------

AANVRAAG:	SCHAAL:	GETEKEND: MN	LEVERWEEK:	1.2a P.14
-----------	---------	-----------------	------------	-----------

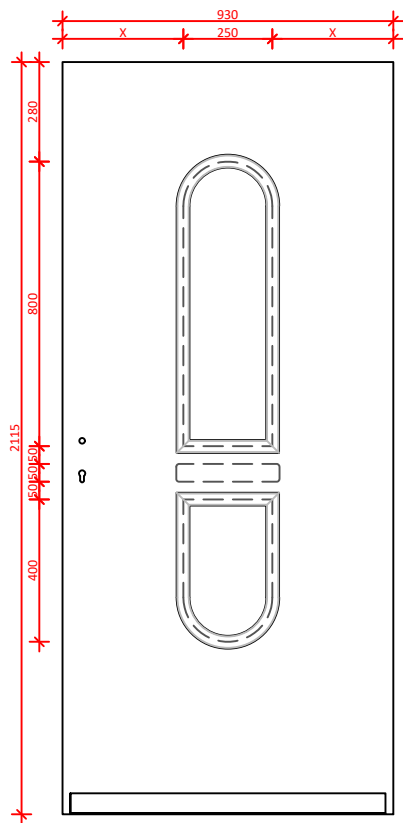

Laag model
1900 - 2200

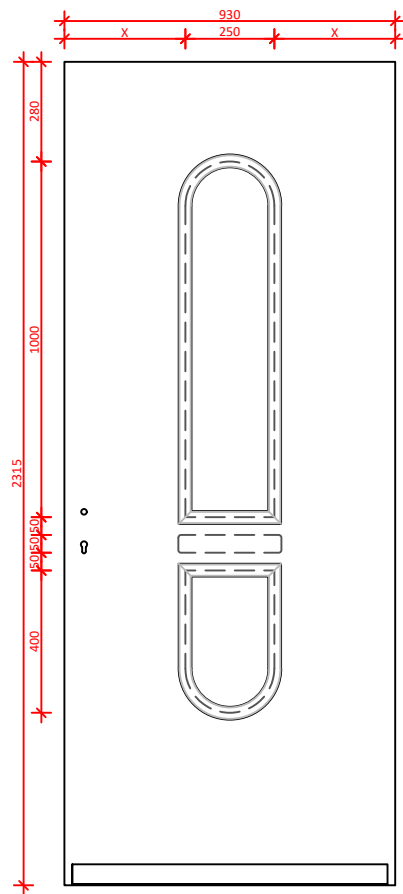

Midden model
2201 - 2400

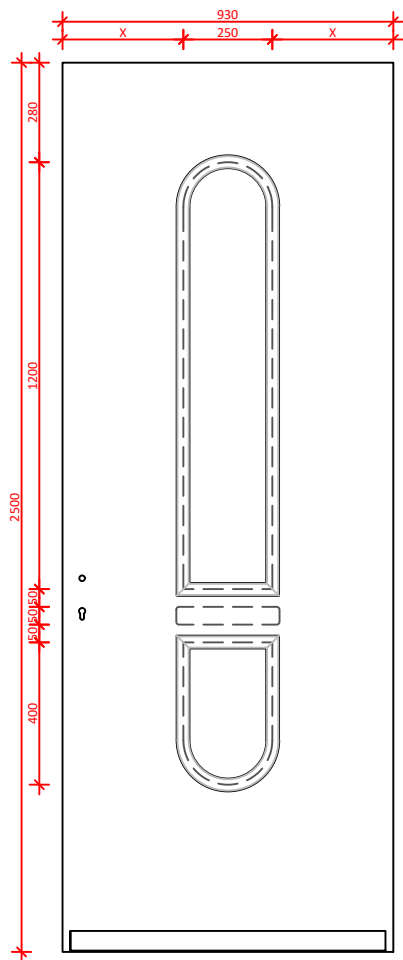

Hoog model
2401 - 2600

DATUM:	GEWIJZIGD:	CALCULATIENR:	TEKENINGNR: 9169N	MODEL:	HOUTSOORT:
			KLANT/PROJECT: overzicht modellen 9169N		DCM NUMMER:
AANVRAAG:		SCHAAL:	GETEKEND: MN	LEVERWEEK: 1.2a P.15	

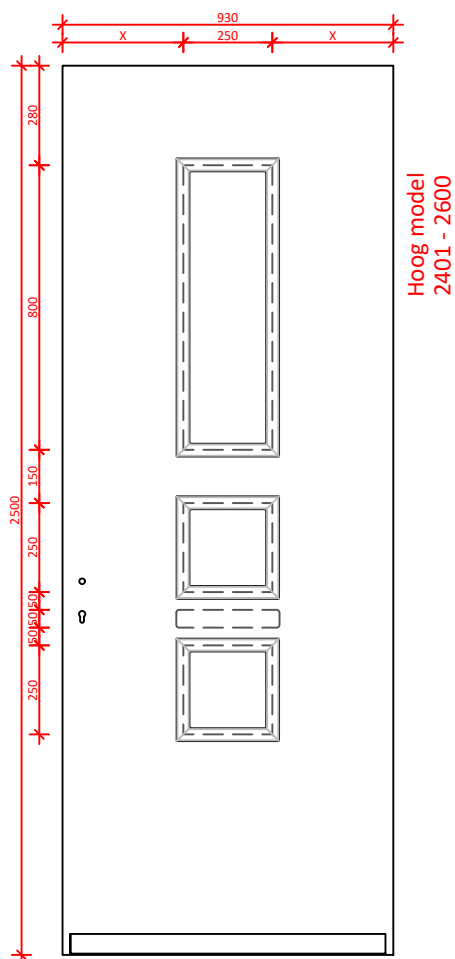
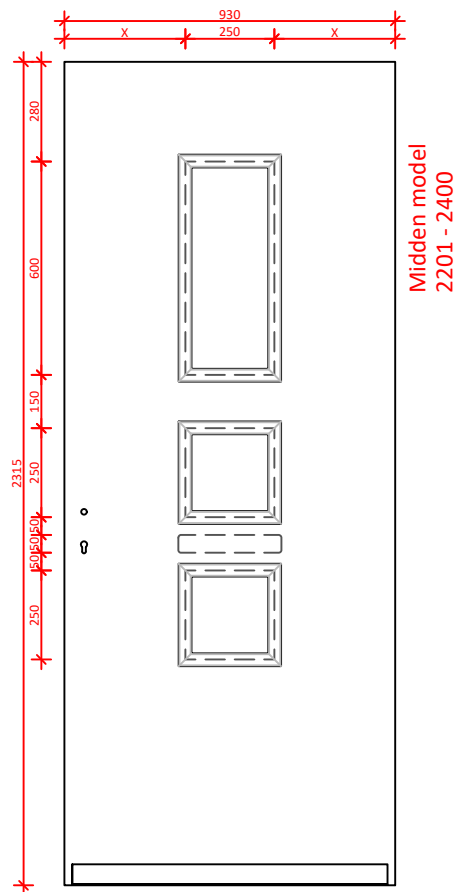
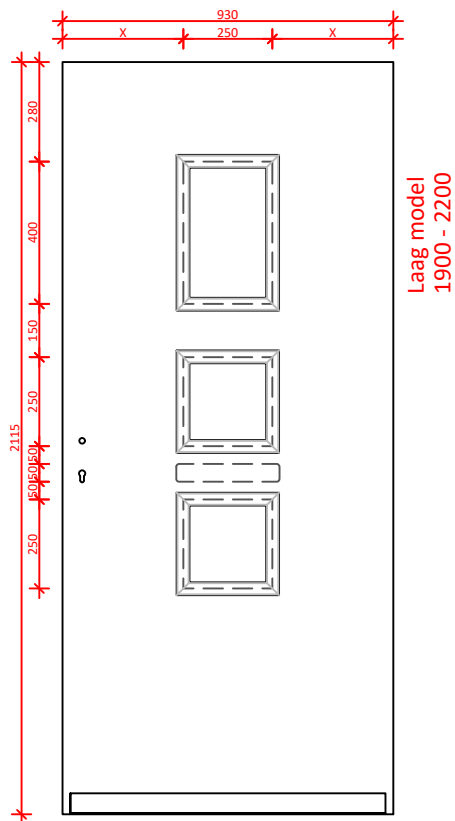

DATUM:	GEWIJZIGD:	CALCULATIENR:	TEKENINGNR:	MODEL: 9170N	HOUTSOORT:
--------	------------	---------------	-------------	-----------------	------------

	KLANT/PROJECT: overzicht modellen 9170N			DCM NUMMER:
--	--	--	--	-------------

AANVRAAG:	SCHAAL:	GETEKEND: MN	LEVERWEEK: 1.2a P.16
-----------	---------	-----------------	-------------------------

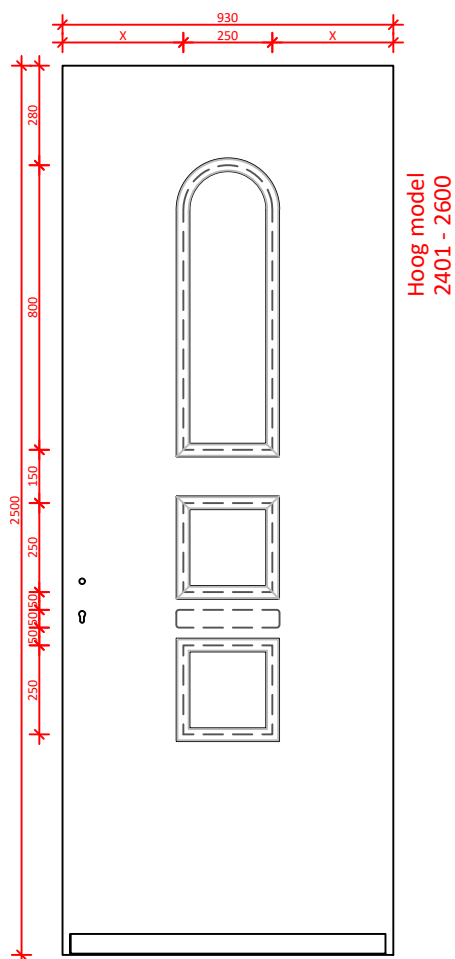
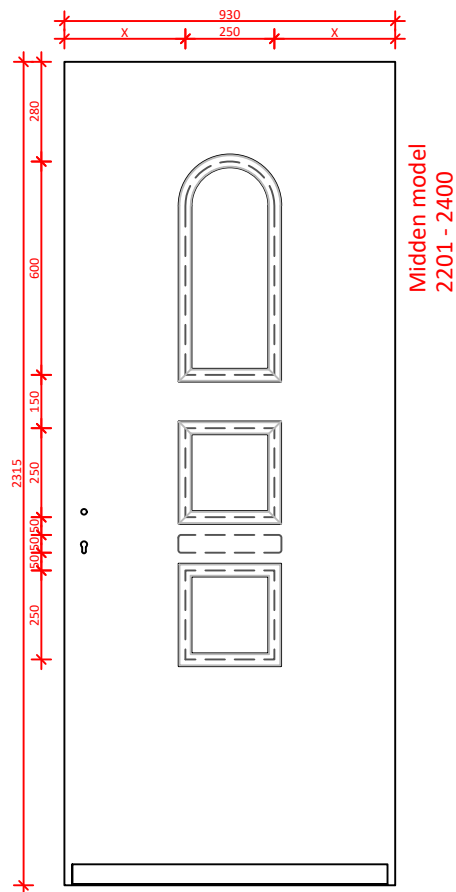
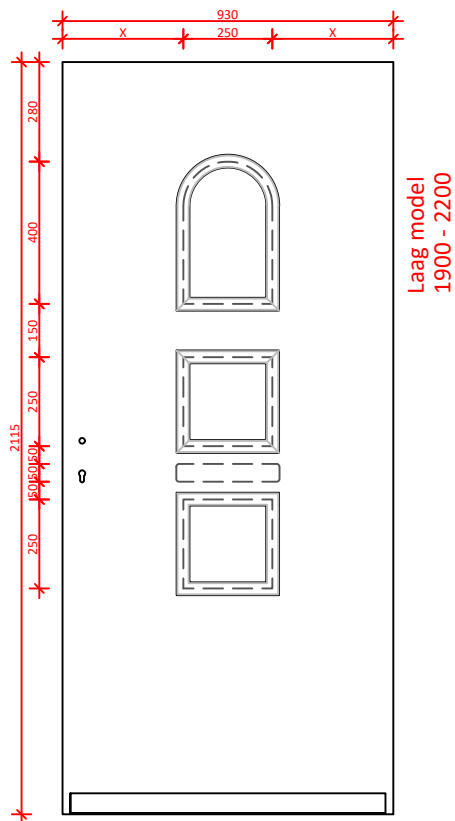

DATUM:	GEWIJZIGD:	CALCULATIENR:	TEKENINGNR:	MODEL: 9171N	HOUTSOORT:
--------	------------	---------------	-------------	-----------------	------------

	KLANT/PROJECT: overzicht modellen 9171N			DCM NUMMER:
--	--	--	--	-------------

AANVRAAG:	SCHAAL:	GETEKEND: MN	LEVERWEEK: 1.2a P.17
-----------	---------	-----------------	-------------------------

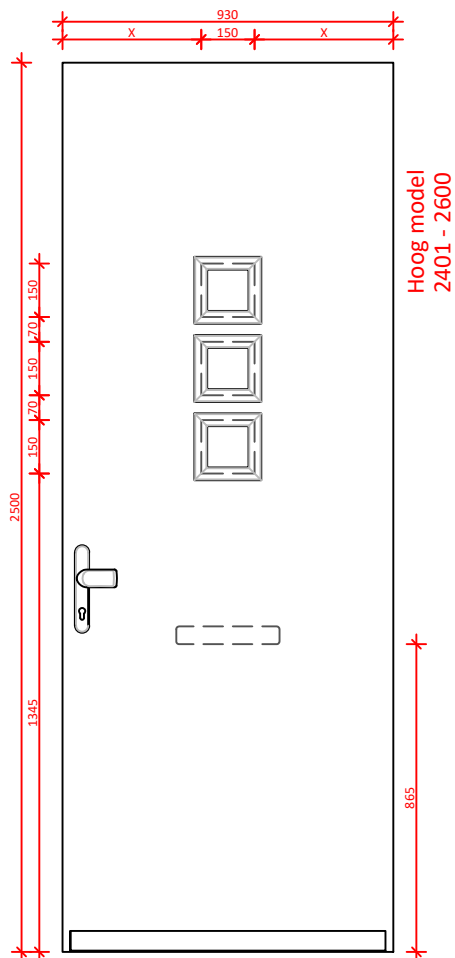
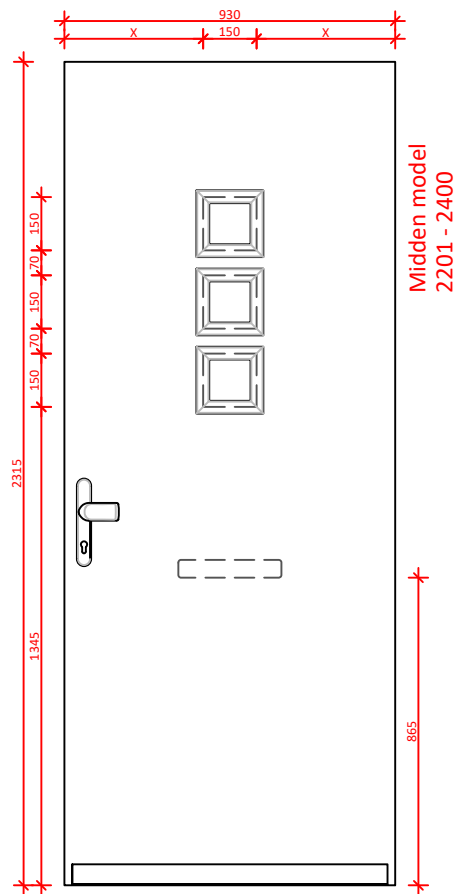
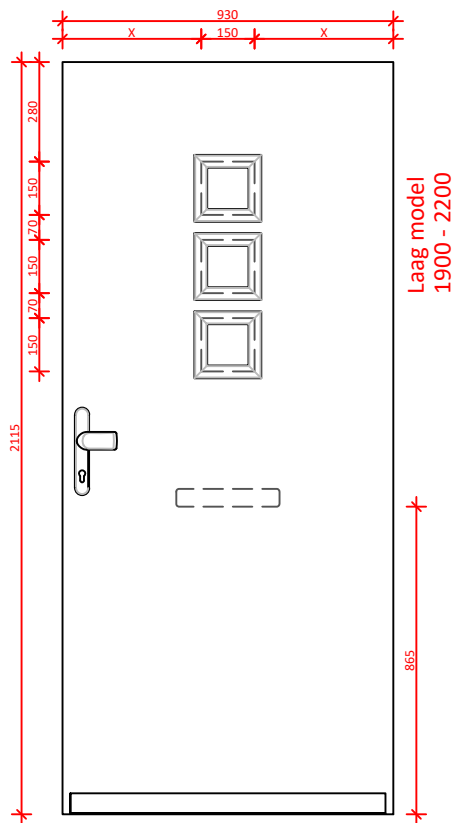

DATUM:	GEWIJZIGD:	CALCULATIENR:	TEKENINGNR:	MODEL: 9172N	HOUTSOORT:
--------	------------	---------------	-------------	-----------------	------------

KEGRO DEUREN	KLANT/PROJECT: overzicht modellen 9172N			DCM NUMMER:
-----------------------	--	--	--	-------------

AANVRAAG:	SCHAAL:	GETEKEND: MN	LEVERWEEK: 1.2a P.18
-----------	---------	-----------------	-------------------------

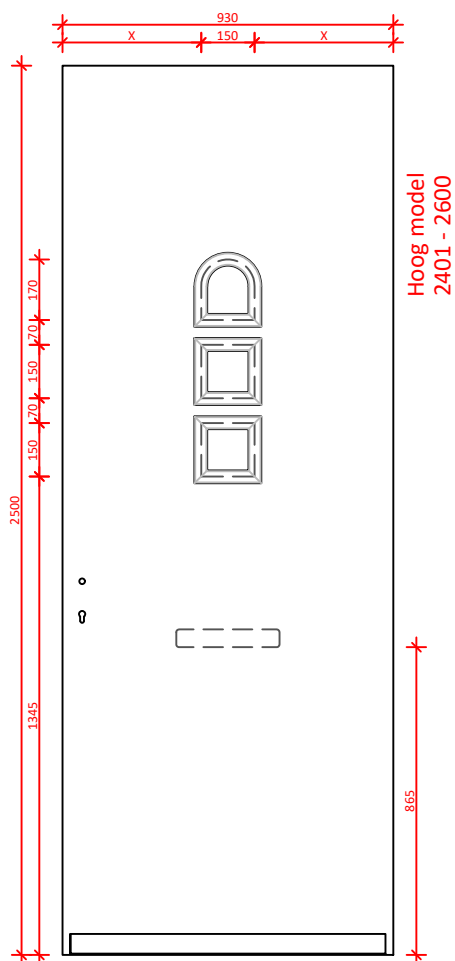
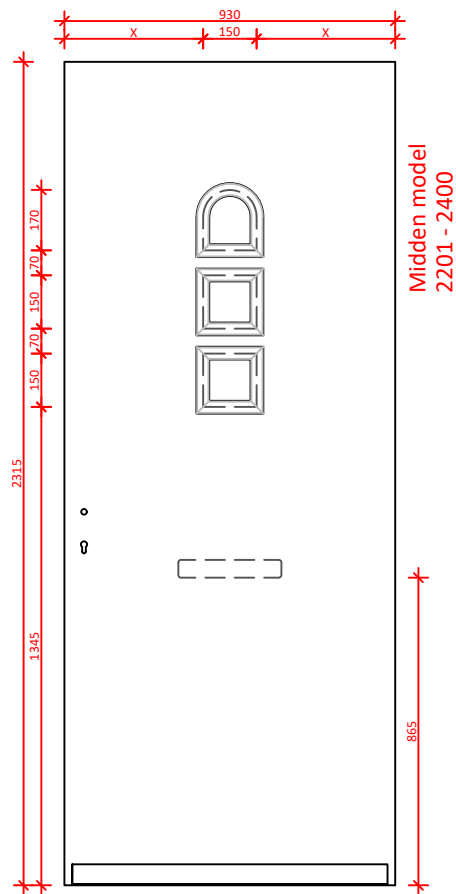
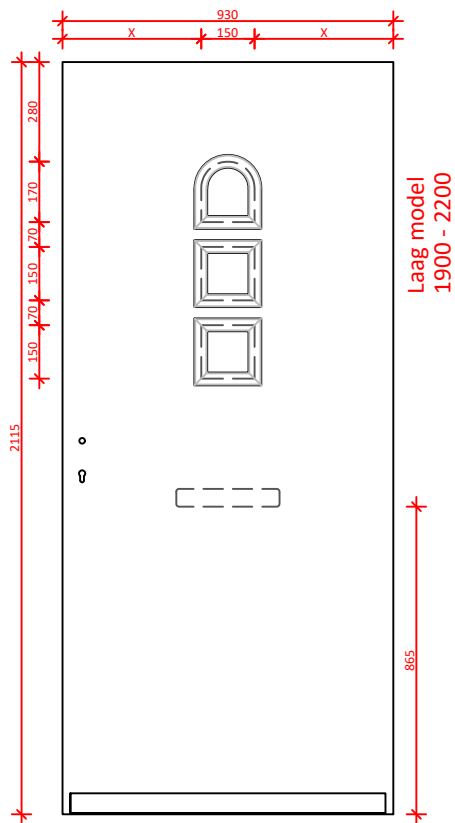

DATUM:	GEWIJZIGD:	CALCULATIENR:	TEKENINGNR:	MODEL: 9173N	HOUTSOORT:
--------	------------	---------------	-------------	-----------------	------------

KEGRO DEUREN	KLANT/PROJECT: overzicht modellen 9173N			DCM NUMMER:
-----------------------	--	--	--	-------------

AANVRAAG:	SCHAAL:	GETEKEND: MN	LEVERWEEK:	1.2a P.19
-----------	---------	-----------------	------------	-----------

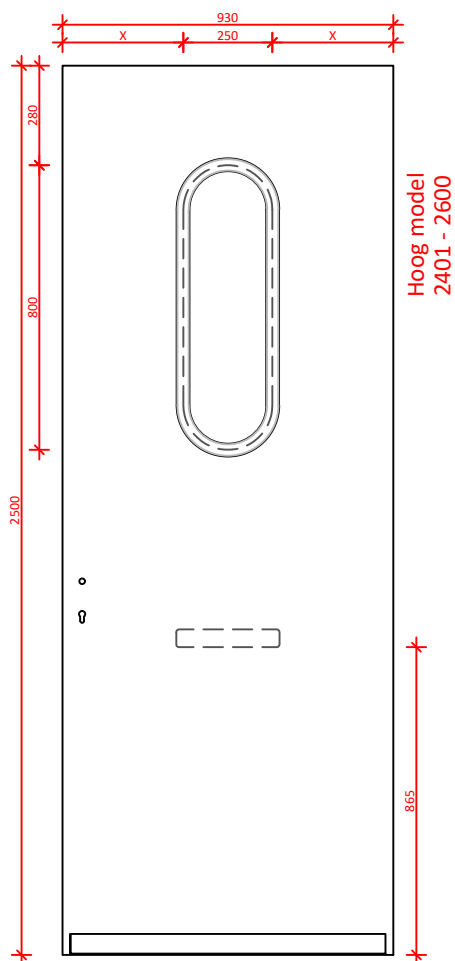
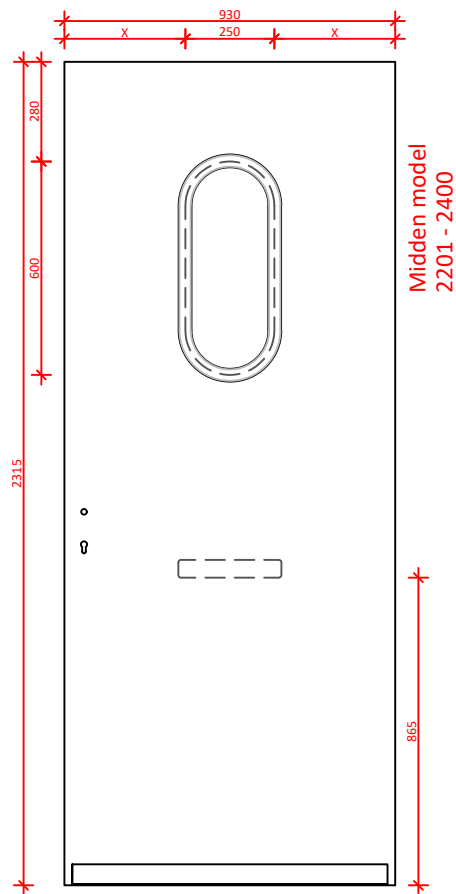
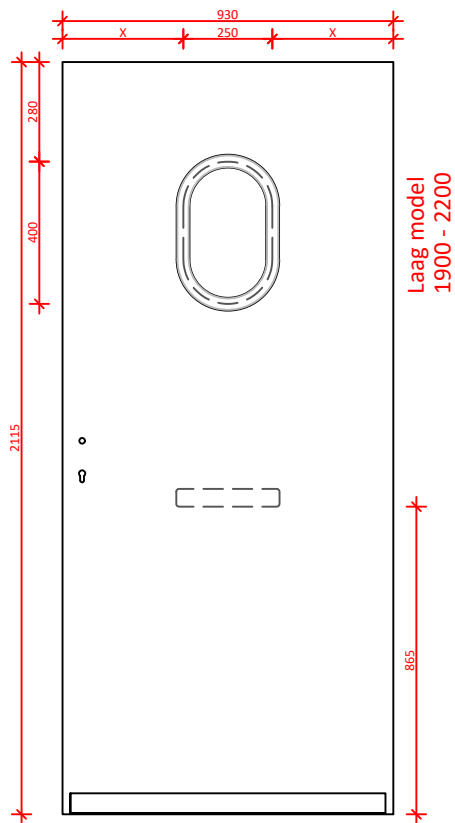

DATUM:	GEWIJZIGD:	CALCULATIENR:	TEKENINGNR:	MODEL: 9174N	HOUTSOORT:
--------	------------	---------------	-------------	-----------------	------------

	KLANT/PROJECT: overzicht modellen 9174N			DCM NUMMER:
--	--	--	--	-------------

AANVRAAG:	SCHAAL:	GETEKEND: MN	LEVERWEEK:	1.2a P.20
-----------	---------	-----------------	------------	-----------

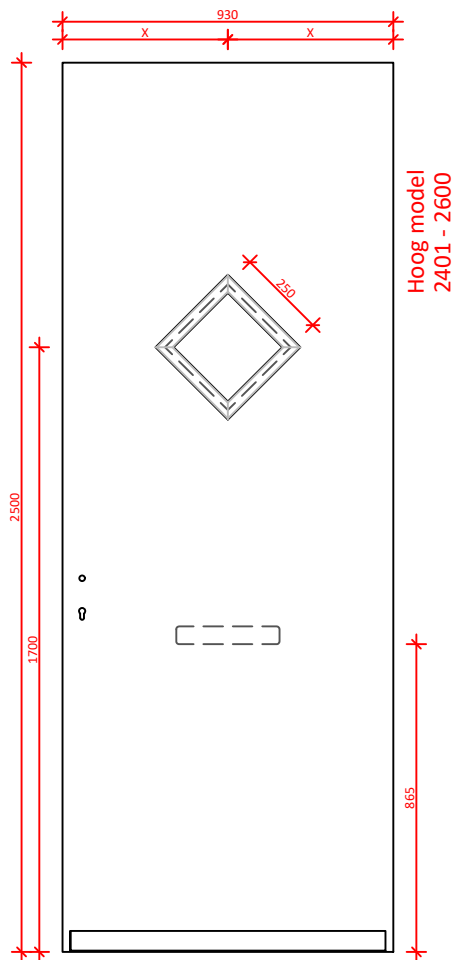
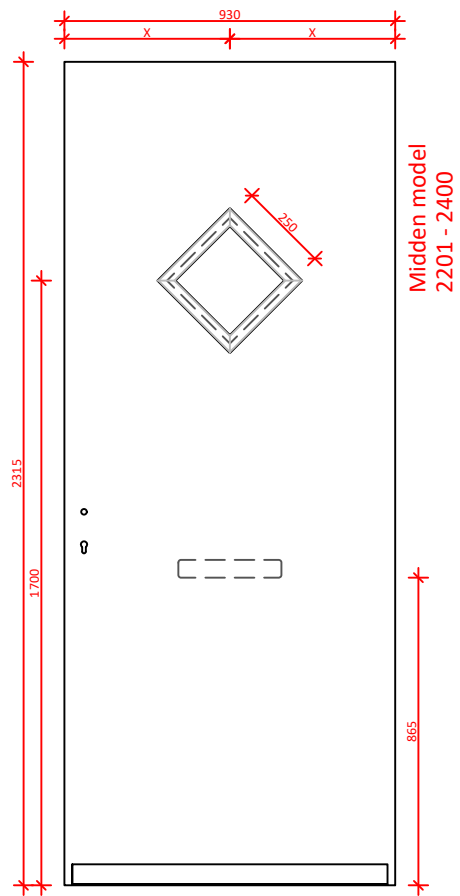
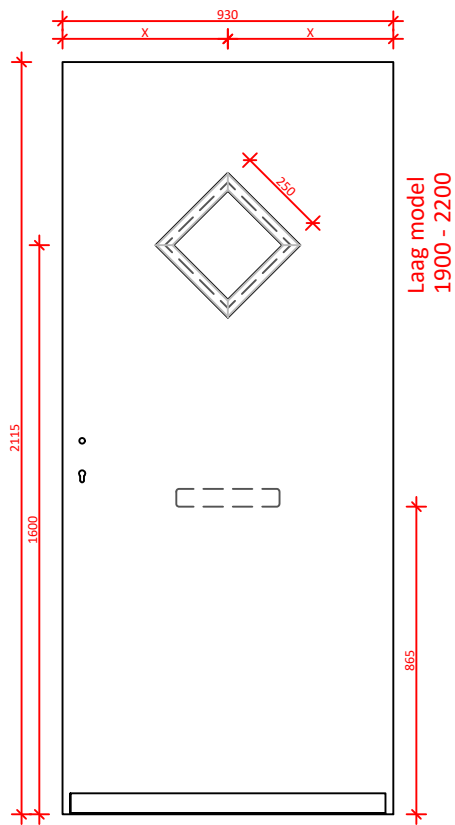

DATUM:	GEWIJZIGD:	CALCULATIENR:	TEKENINGNR:	MODEL: 9175N	HOUTSOORT:
--------	------------	---------------	-------------	-----------------	------------

	KLANT/PROJECT: overzicht modellen 9175N			DCM NUMMER:
--	--	--	--	-------------

AANVRAAG:	SCHAAL:	GETEKEND: MN	LEVERWEEK:	1.2a P.21
-----------	---------	-----------------	------------	-----------

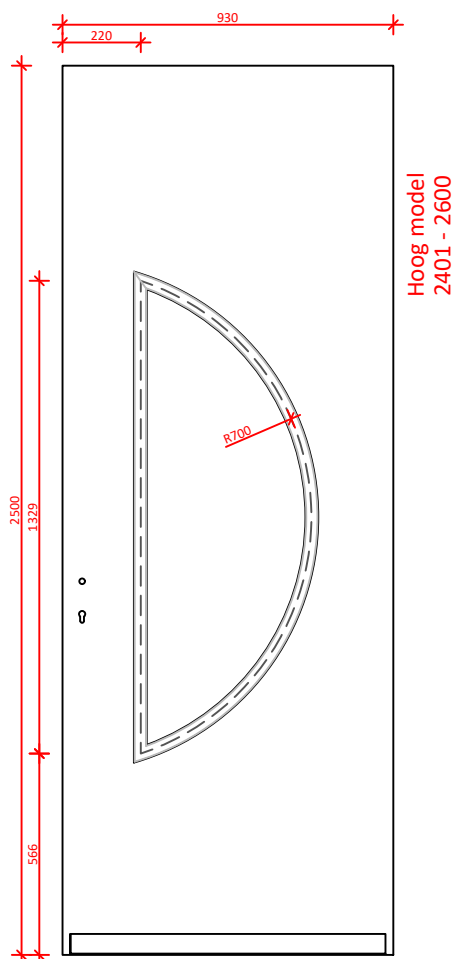
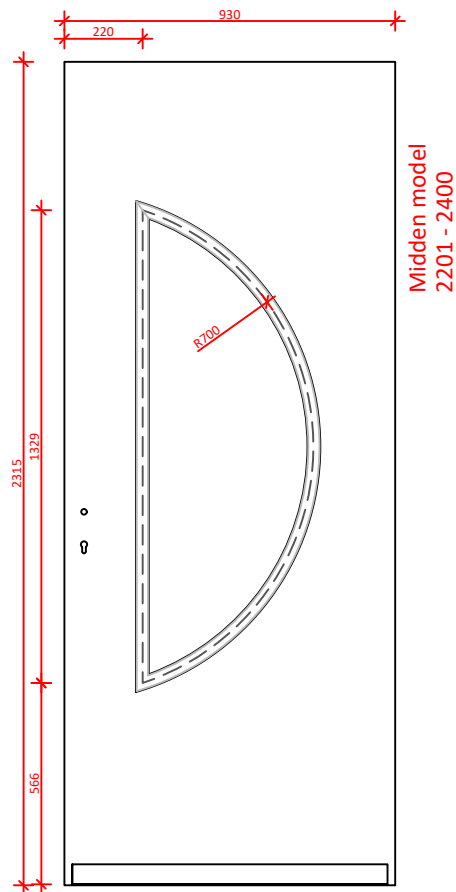
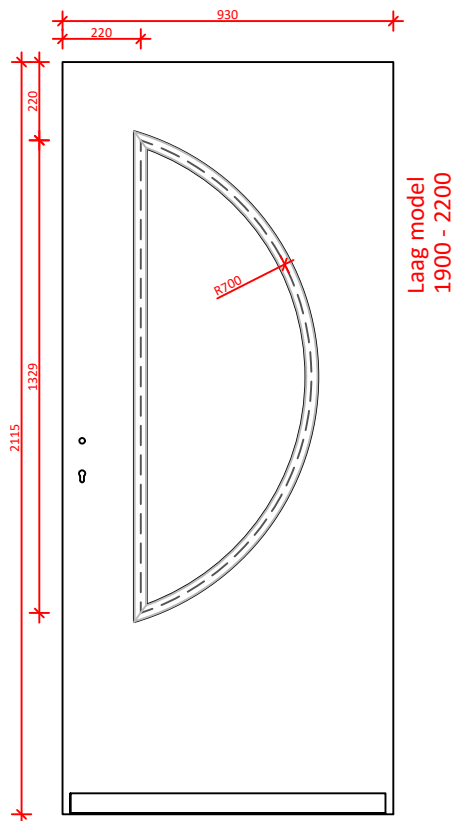

DATUM:	GEWIJZIGD:	CALCULATIENR:	TEKENINGNR:	MODEL: 9176N	HOUTSOORT:
--------	------------	---------------	-------------	-----------------	------------

	KLANT/PROJECT: overzicht modellen 9176N L1 - R4			DCM NUMMER:
--	--	--	--	-------------

AANVRAAG:	SCHAAL:	GETEKEND: MN	LEVERWEEK: 1.2a P.22
-----------	---------	-----------------	-------------------------

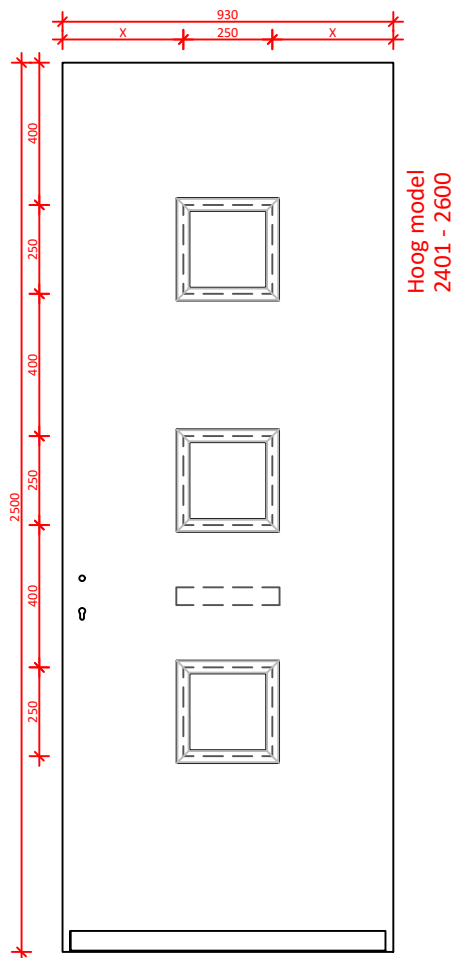
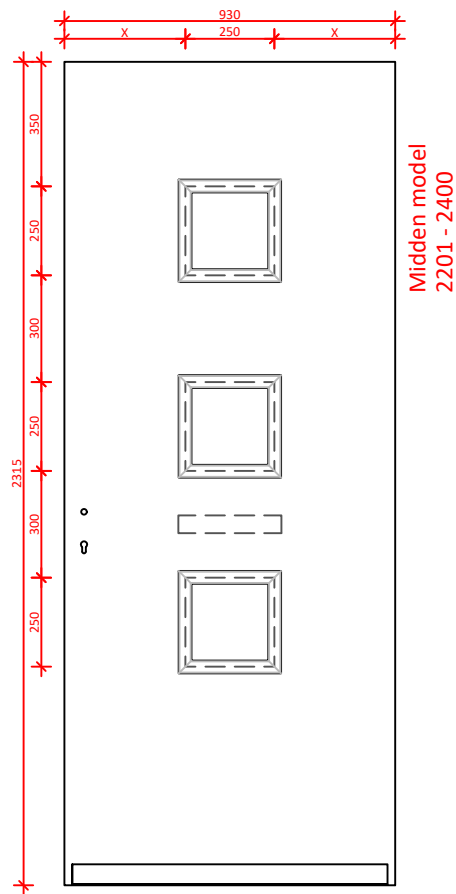
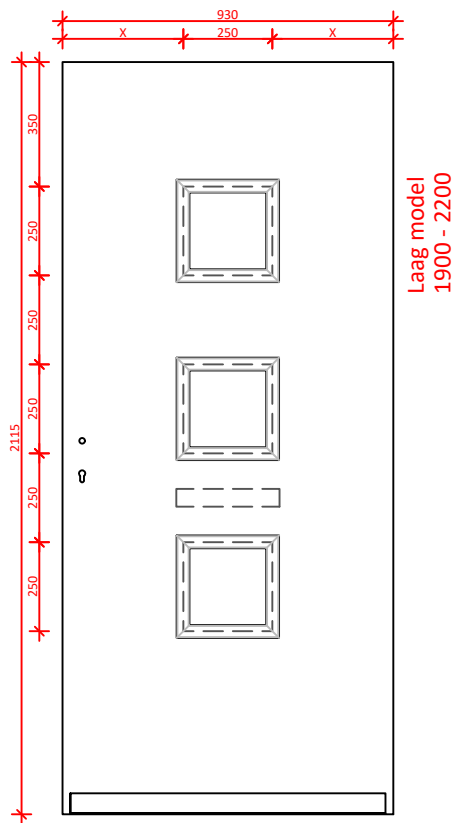

DATUM:	GEWIJZIGD:	CALCULATIENR:	TEKENINGNR:	MODEL: 9178N	HOUTSOORT:
--------	------------	---------------	-------------	-----------------	------------

KEGRO DEUREN	KLANT/PROJECT: overzicht modellen 9178N			DCM NUMMER:
-----------------------	--	--	--	-------------

AANVRAAG:	SCHAAL:	GETEKEND: MN	LEVERWEEK: 1.2a P.23
-----------	---------	-----------------	-------------------------

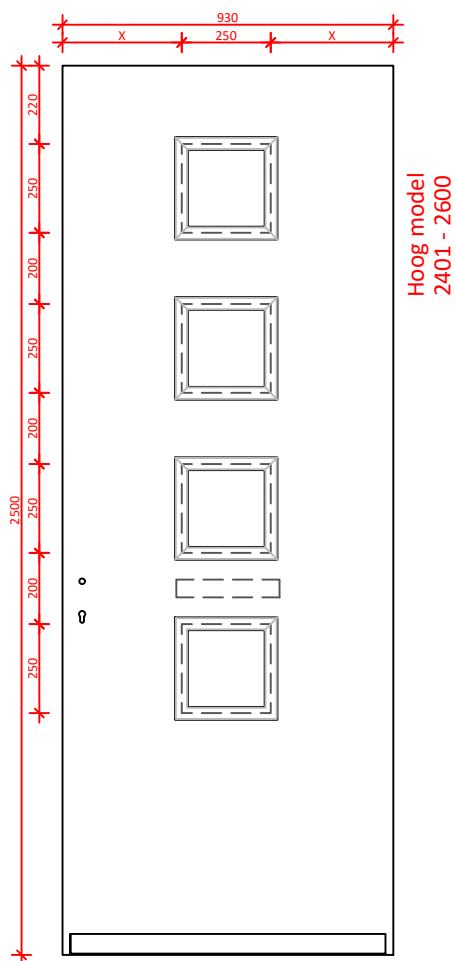
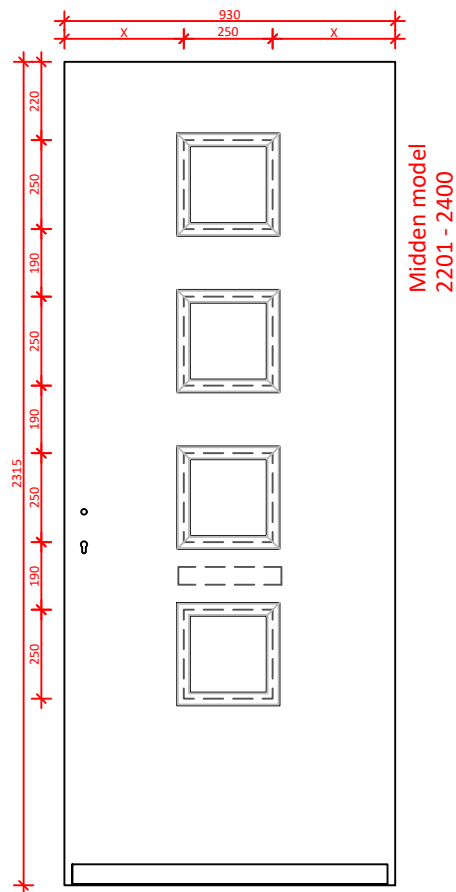
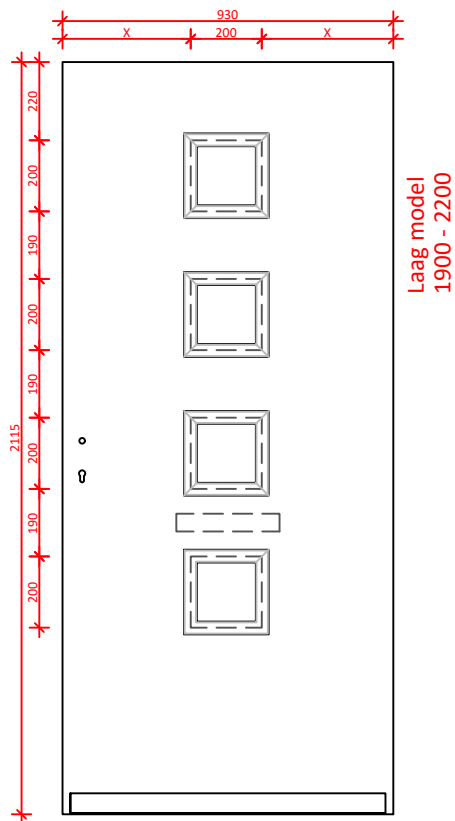

DATUM:	GEWIJZIGD:	CALCULATIENR:	TEKENINGNR:	MODEL: 9179N	HOUTSOORT:
--------	------------	---------------	-------------	-----------------	------------

	KLANT/PROJECT: overzicht modellen 9179N			DCM NUMMER:
--	--	--	--	-------------

AANVRAAG:	SCHAAL:	GETEKEND: MN	LEVERWEEK: 1.2a P.24
-----------	---------	-----------------	-------------------------

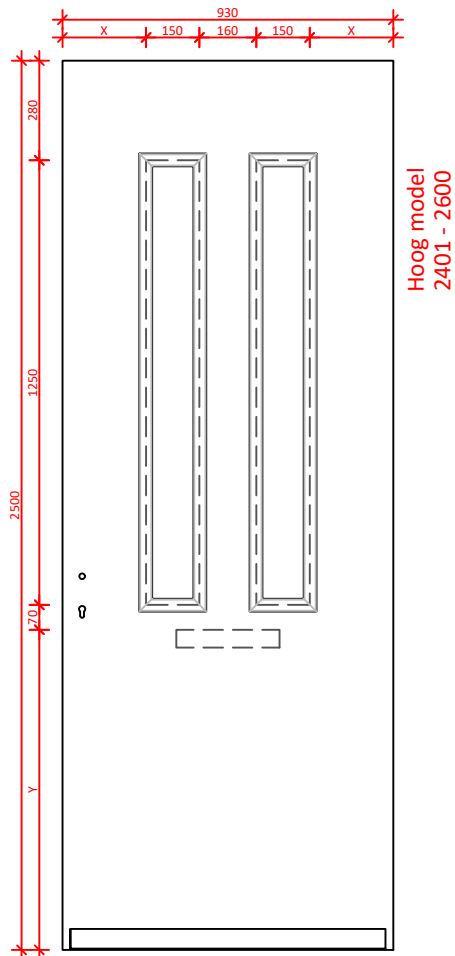
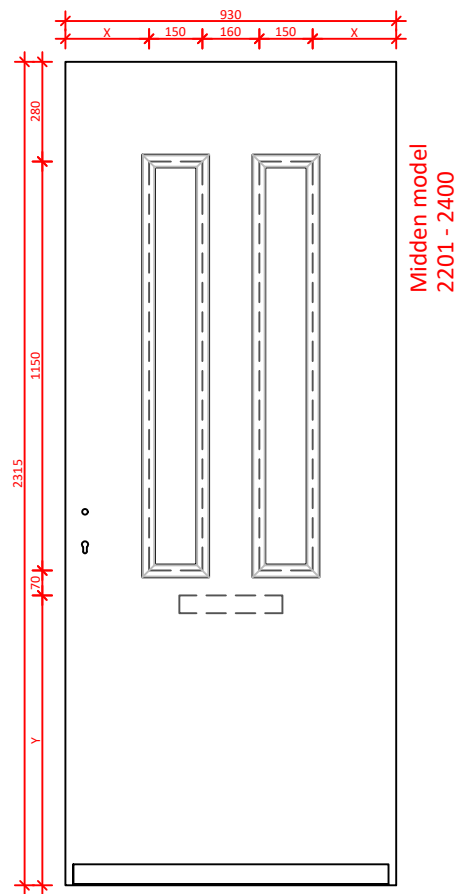
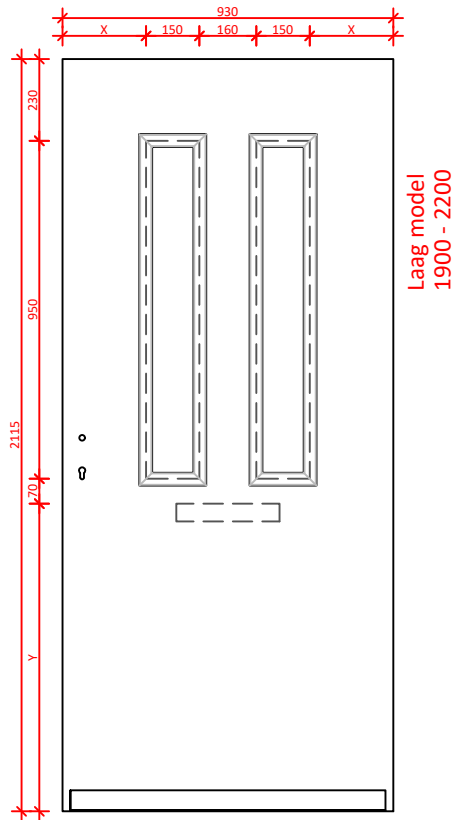

DATUM:	GEWIJZIGD:	CALCULATIENR:	TEKENINGNR:	MODEL: 9180N	HOUTSOORT:
--------	------------	---------------	-------------	-----------------	------------

KEGRO DEUREN	KLANT/PROJECT: overzicht modellen 9180N			DCM NUMMER:
-----------------------	--	--	--	-------------

AANVRAAG:	SCHAAL:	GETEKEND: MN	LEVERWEEK: 1.2a P.25
-----------	---------	-----------------	-------------------------

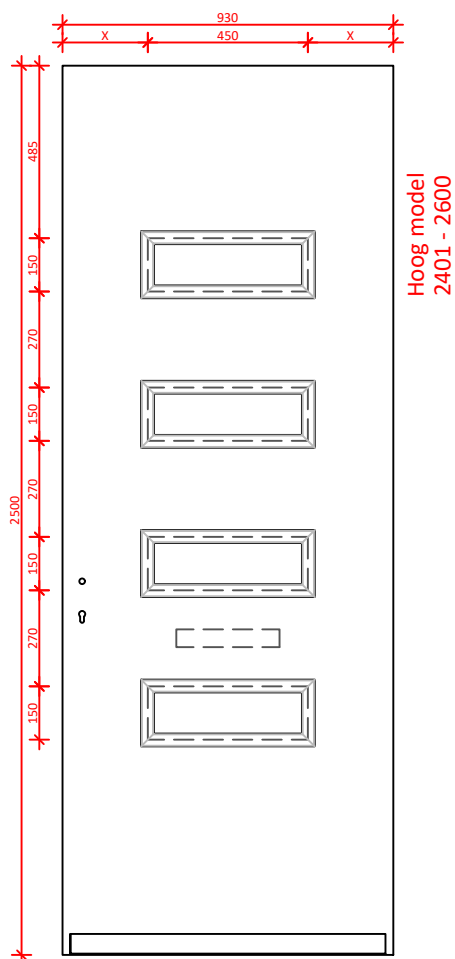
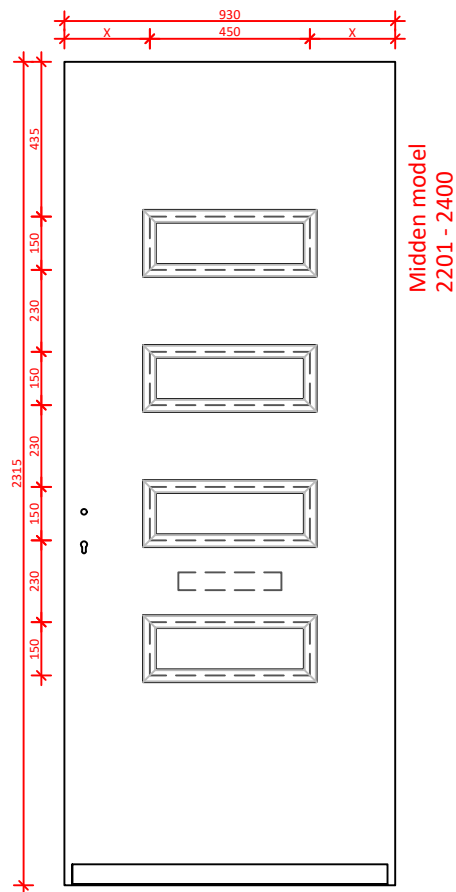
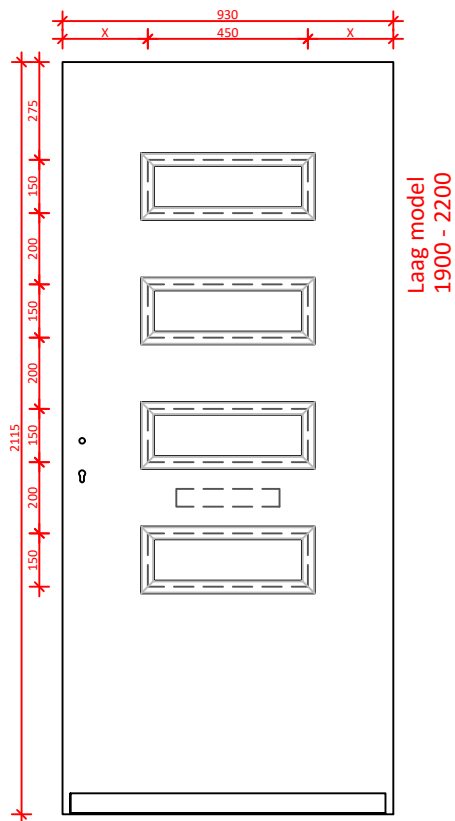

Strakke SponningMaat van de glasopening:
 Pasmaat deurbreedte t/m 1000 mm : SSM 450mm
 Pasmaat deurbreedte 1001 t/m 1100 mm : SSM 550mm
 Pasmaat deurbreedte > 1101 mm : SSM 650mm

DATUM:	GEWIJZIGD:	CALCULATIENR:	TEKENINGNR:	MODEL: 9181N	HOUTSOORT:
			KLANT/PROJECT: overzicht modellen 9181N		DCM NUMMER:
AANVRAAG:		SCHAAL:	GETEKEND: MN	LEVERWEEK: 1.2a P.26	

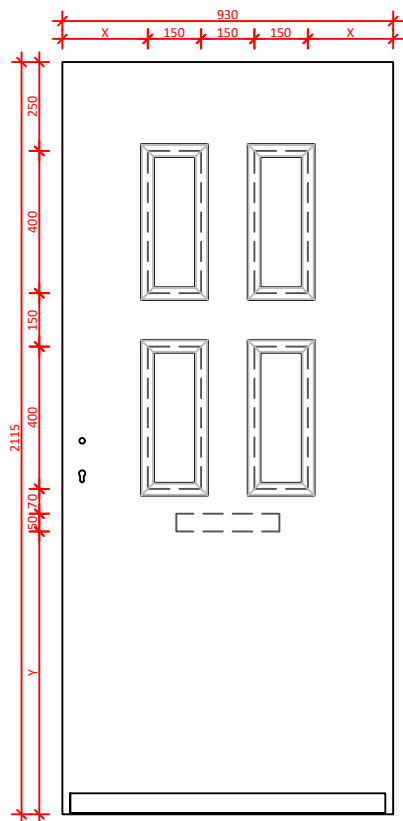

Laag model
1900 - 2200

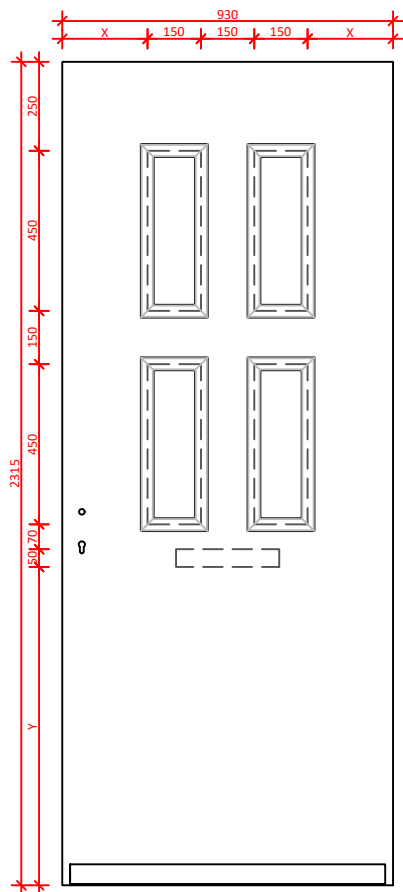

Midden model
2201 - 2400

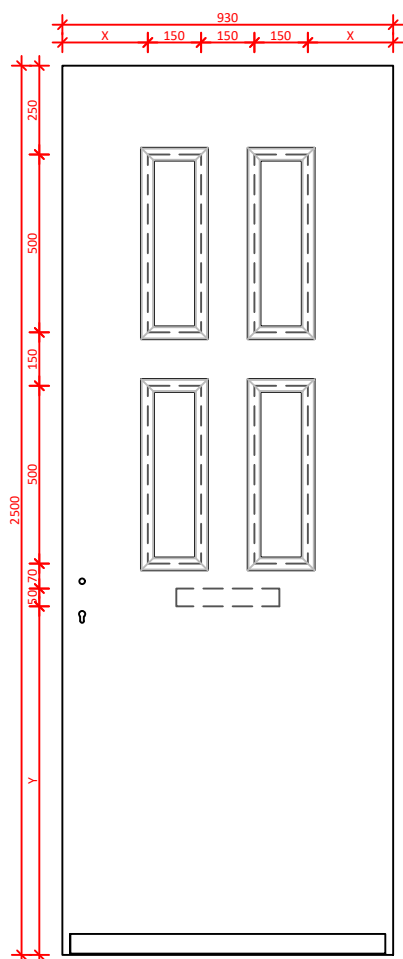

Hoog model
2401 - 2600

DATUM:	GEWIJZIGD:	CALCULATIENR:	TEKENINGNR:	MODEL: 9182N	HOUTSOORT:
--------	------------	---------------	-------------	-----------------	------------

	KLANT/PROJECT: overzicht modellen 9182N			DCM NUMMER:
--	--	--	--	-------------

AANVRAAG:	SCHAAL:	GETEKEND: MN	LEVERWEEK: 1.2a P.27
-----------	---------	-----------------	-------------------------

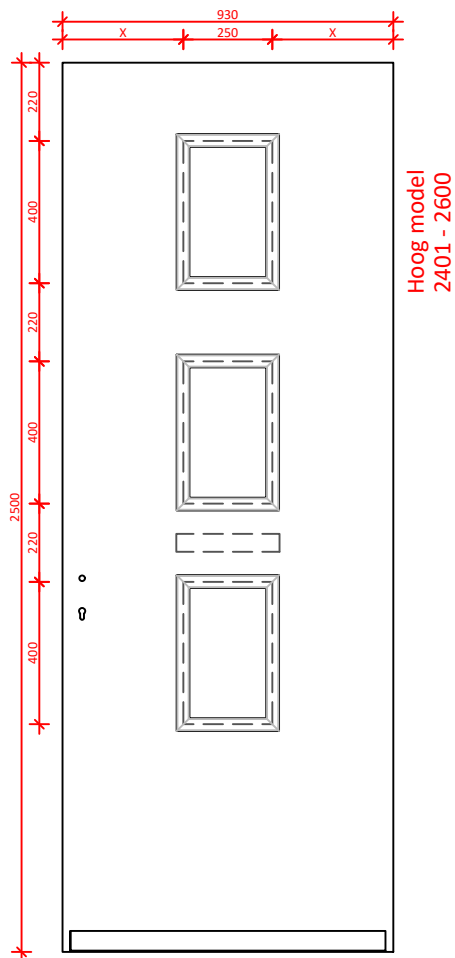
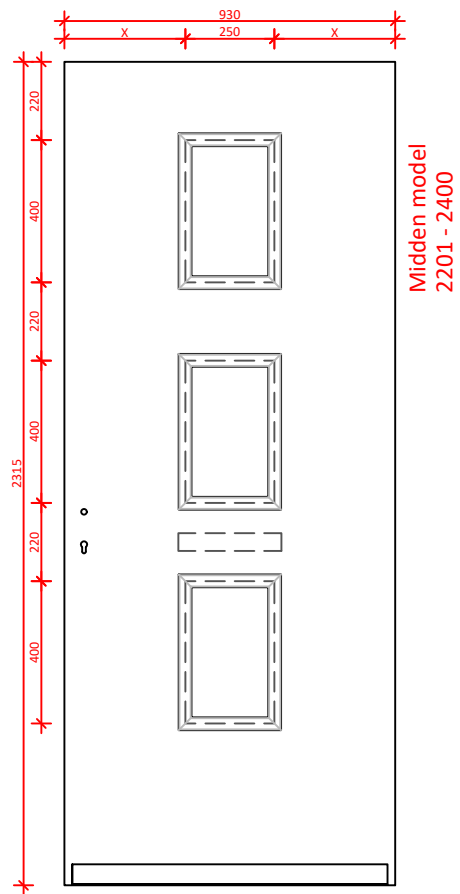
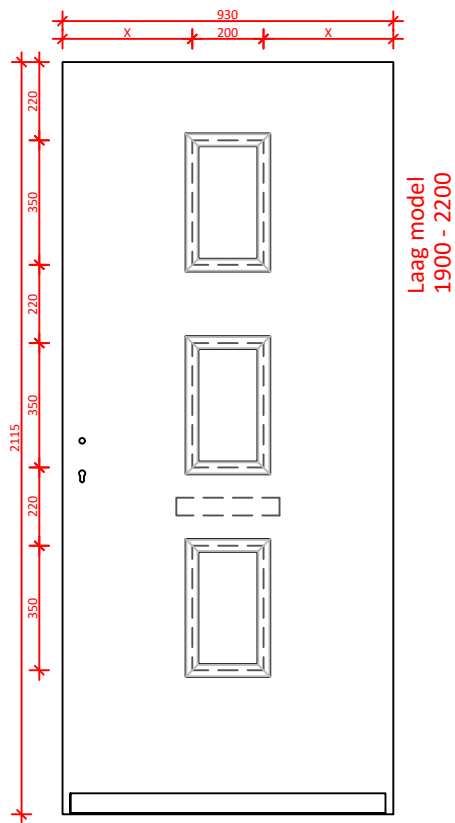

DATUM:	GEWIJZIGD:	CALCULATIENR:	TEKENINGNR:	MODEL: 9183N	HOUTSOORT:
--------	------------	---------------	-------------	-----------------	------------

	KLANT/PROJECT: overzicht modellen 9183N			DCM NUMMER:
--	--	--	--	-------------

AANVRAAG:	SCHAAL:	GETEKEND: MN	LEVERWEEK:	1.2a P.28
-----------	---------	-----------------	------------	-----------

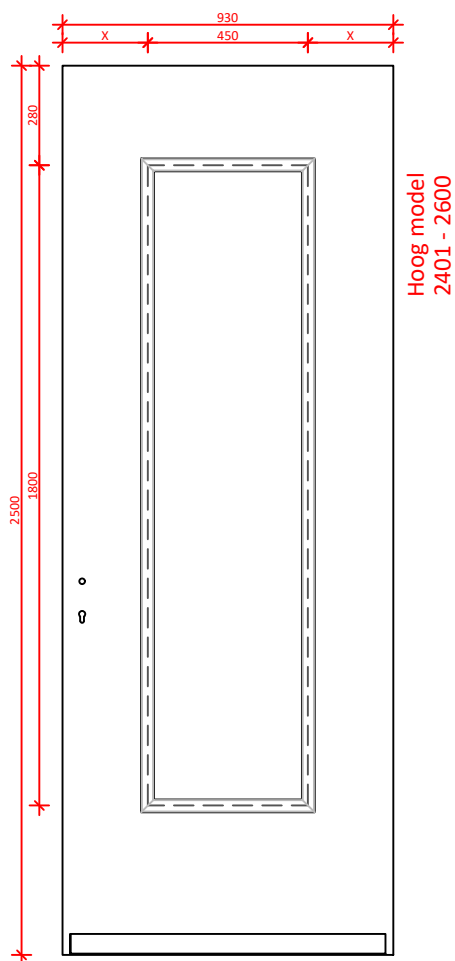
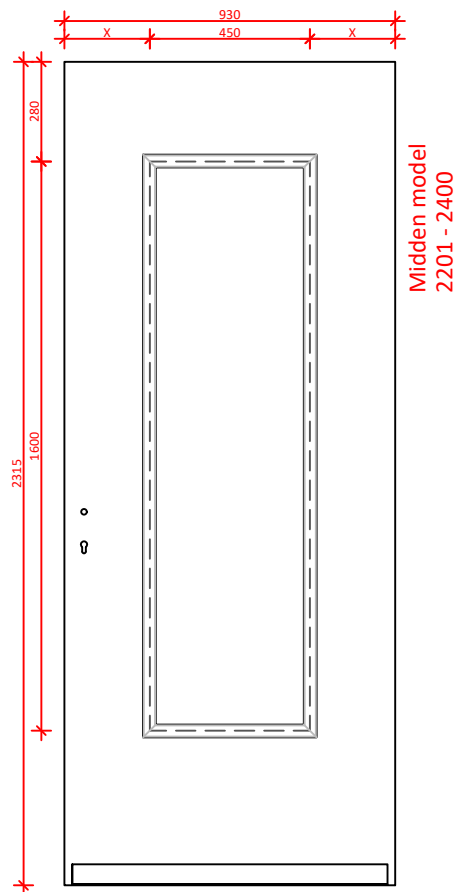
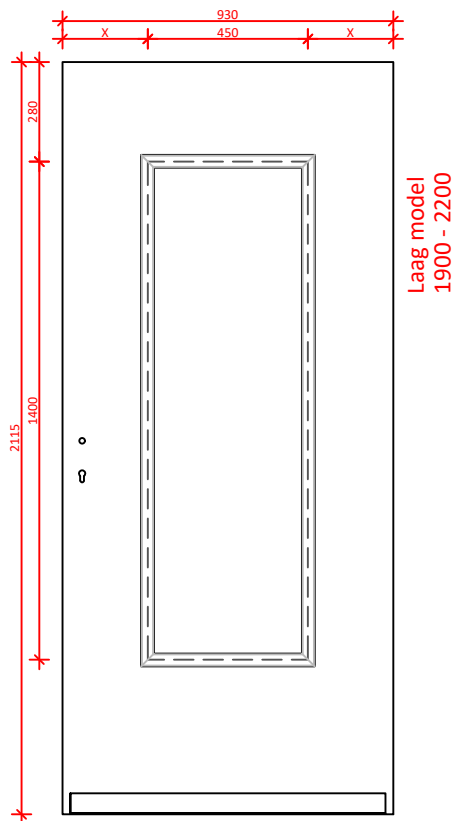

DATUM:	GEWIJZIGD:	CALCULATIENR:	TEKENINGNR:	MODEL: 9195N	HOUTSOORT:
--------	------------	---------------	-------------	-----------------	------------

	KLANT/PROJECT: overzicht modellen 9195N			DCM NUMMER:
--	--	--	--	-------------

AANVRAAG:	SCHAAL:	GETEKEND: MN	LEVERWEEK: 1.2a P.29
-----------	---------	-----------------	-------------------------

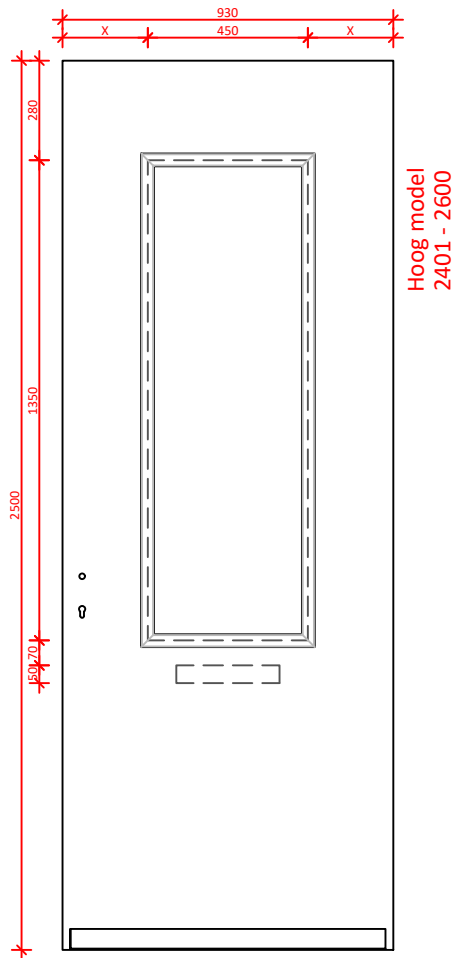
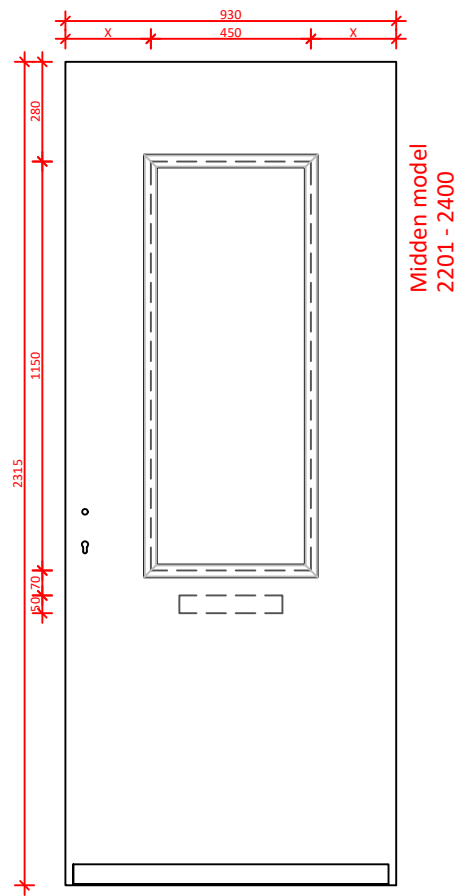
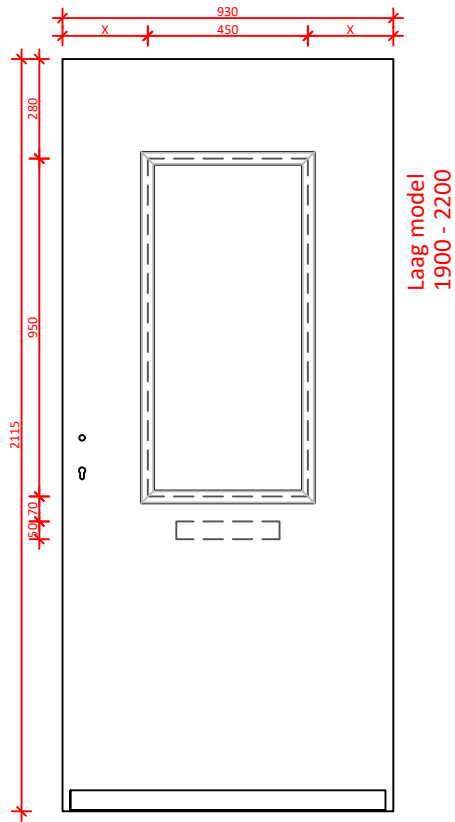

DATUM:	GEWIJZIGD:	CALCULATIENR:	TEKENINGNR:	MODEL: 9196N	HOUTSOORT:
--------	------------	---------------	-------------	-----------------	------------

	KLANT/PROJECT: overzicht modellen 9196N			DCM NUMMER:
--	--	--	--	-------------

AANVRAAG:	SCHAAL:	GETEKEND: MN	LEVERWEEK: 1.2a P.30
-----------	---------	-----------------	-------------------------

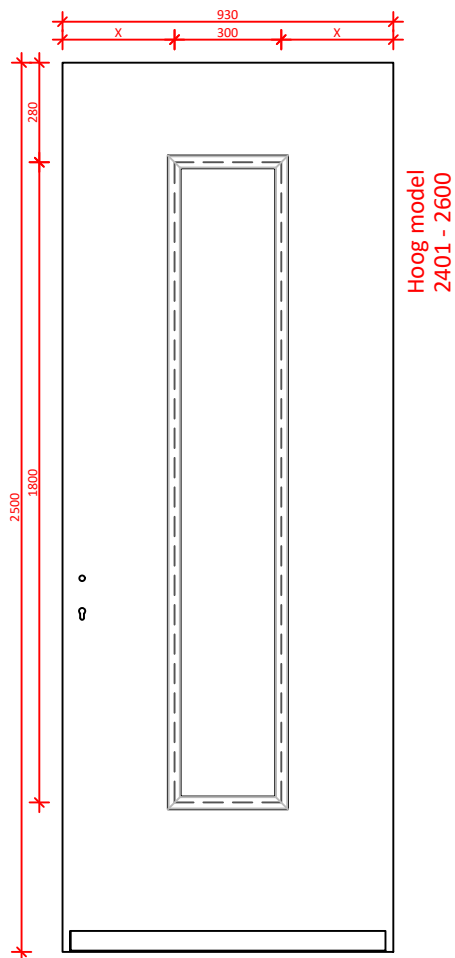
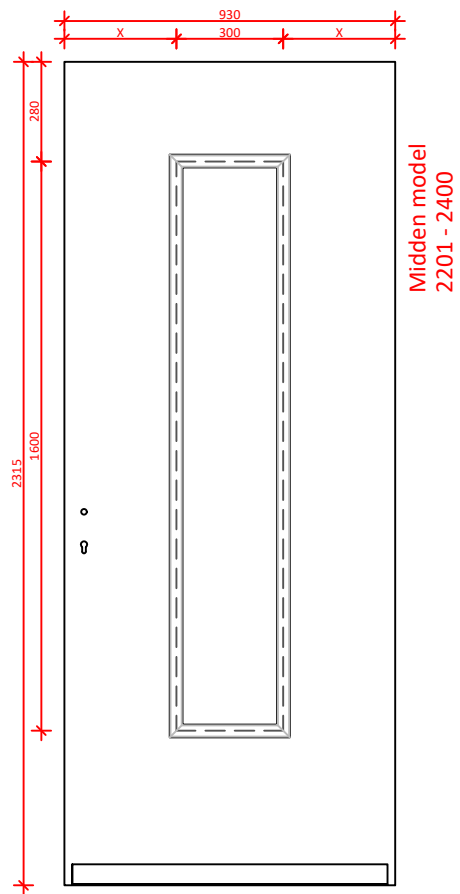
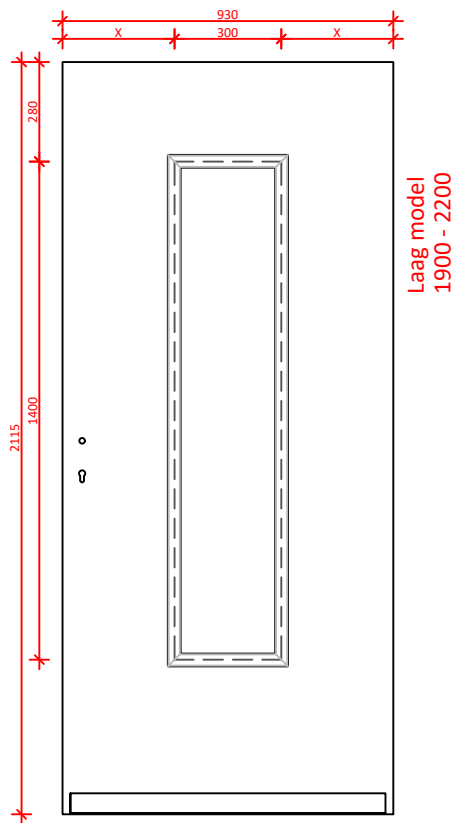

DATUM:	GEWIJZIGD:	CALCULATIENR:	TEKENINGNR:	MODEL: 9197N	HOUTSOORT:
--------	------------	---------------	-------------	-----------------	------------

	KLANT/PROJECT: overzicht modellen 9197N			DCM NUMMER:
--	--	--	--	-------------

AANVRAAG:	SCHAAL:	GETEKEND: MN	LEVERWEEK:	1.2a P.31
-----------	---------	-----------------	------------	-----------

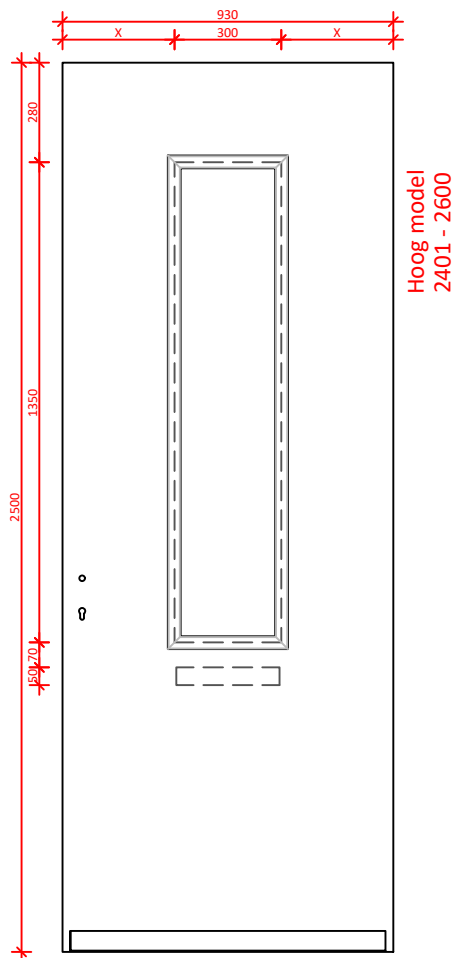
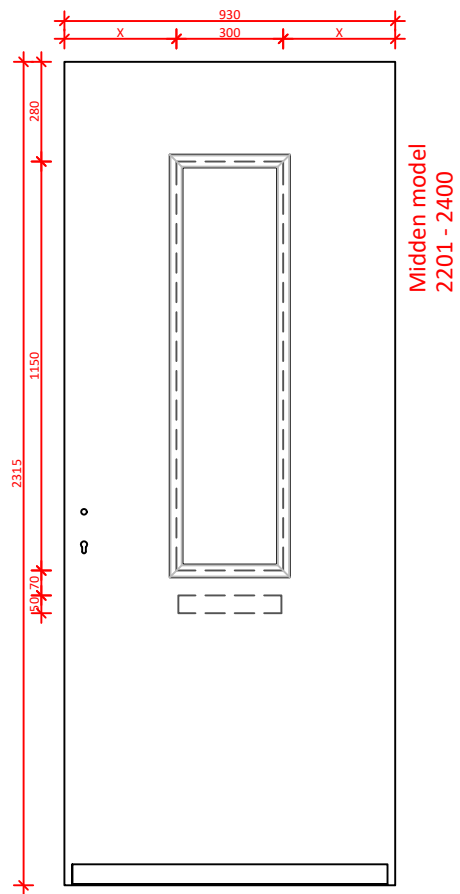
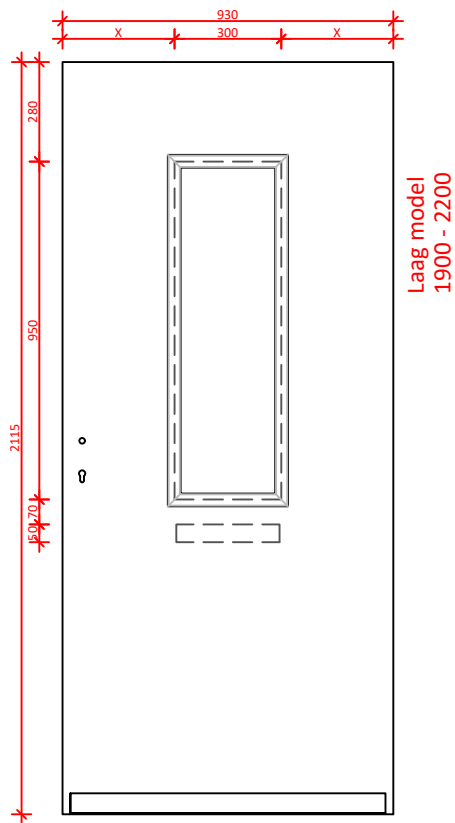

DATUM:	GEWIJZIGD:	CALCULATIENR:	TEKENINGNR:	MODEL: 9198N	HOUTSOORT:
--------	------------	---------------	-------------	-----------------	------------

	KLANT/PROJECT: overzicht modellen 9198N			DCM NUMMER:
--	--	--	--	-------------

AANVRAAG:	SCHAAL:	GETEKEND: MN	LEVERWEEK: 1.2a P.32
-----------	---------	-----------------	-------------------------

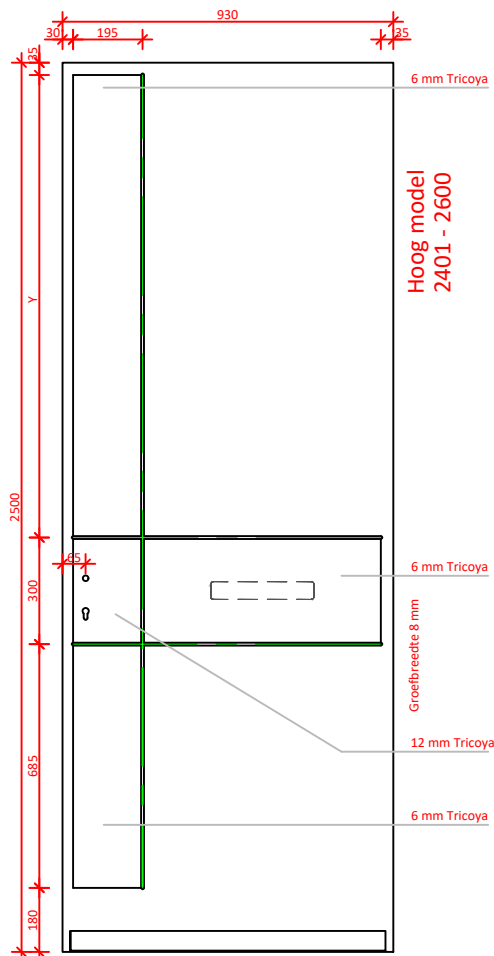
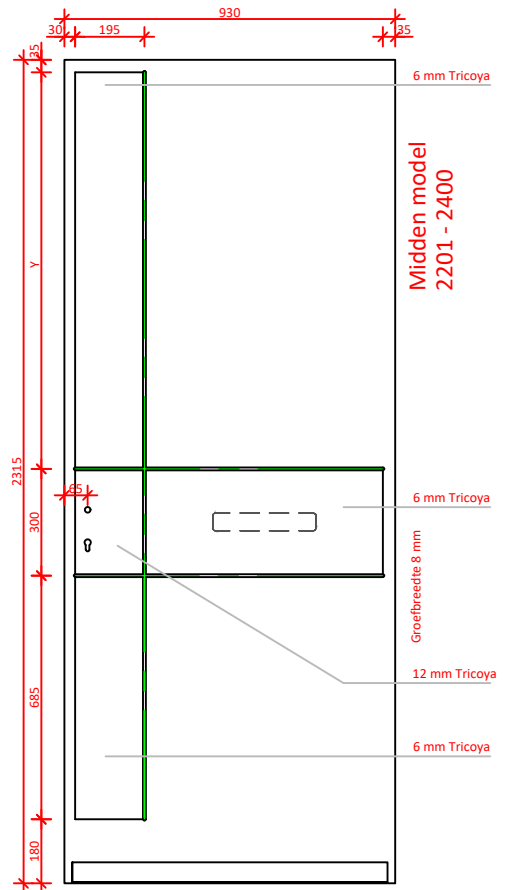
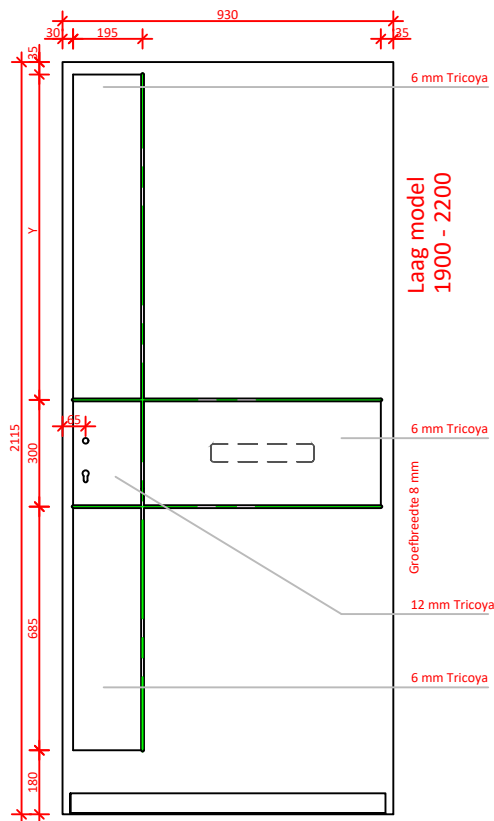

MAATVOERING WIJZIGT INDIEN SENIOREN SLOT WORDT TOEGEPAST
MINIMAAL DOORNMAAT 65 TOEPASSEN IVM MOGELIJKE BVT OPLOSSING EN PLAATMATERIAAL

DATUM:	GEWIJZIGD:	CALCULATIENR:	TEKENINGNR:	MODEL: 9401	HOUTSOORT:
--------	------------	---------------	-------------	----------------	------------

	KLANT/PROJECT: overzicht modellen 9401 L1 - R4			DCM NUMMER:
--	---	--	--	-------------

AANVRAAG:	SCHAAL:	GETEKEND: MN	LEVERWEEK: 1.2a P.33
-----------	---------	-----------------	-------------------------

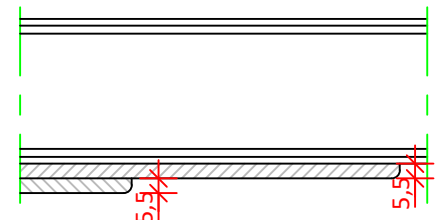
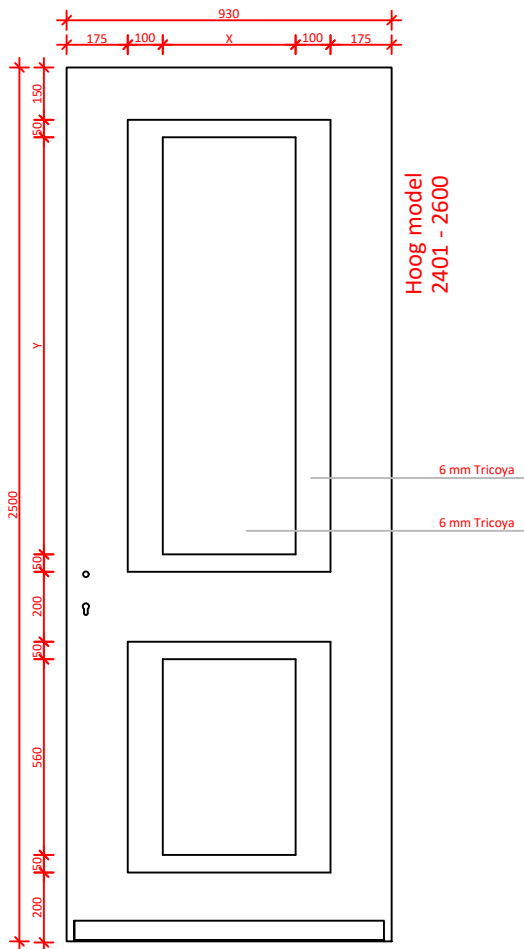
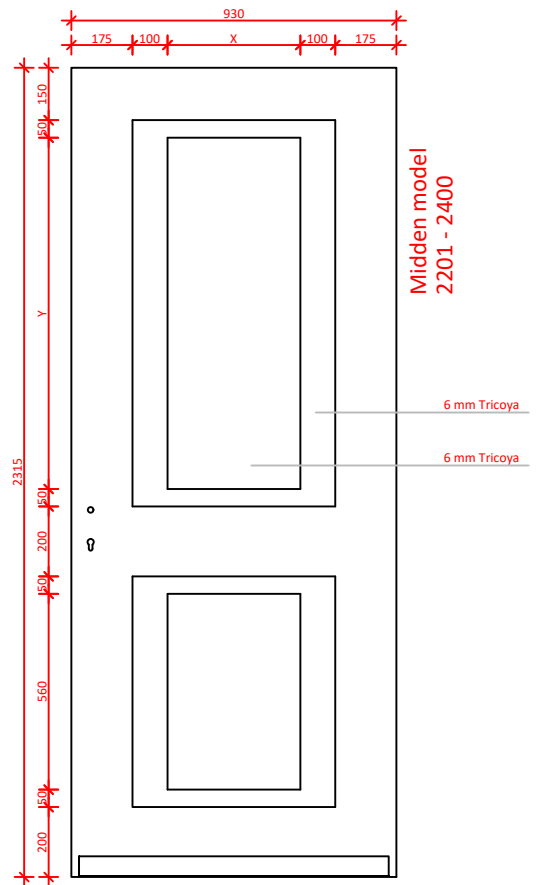
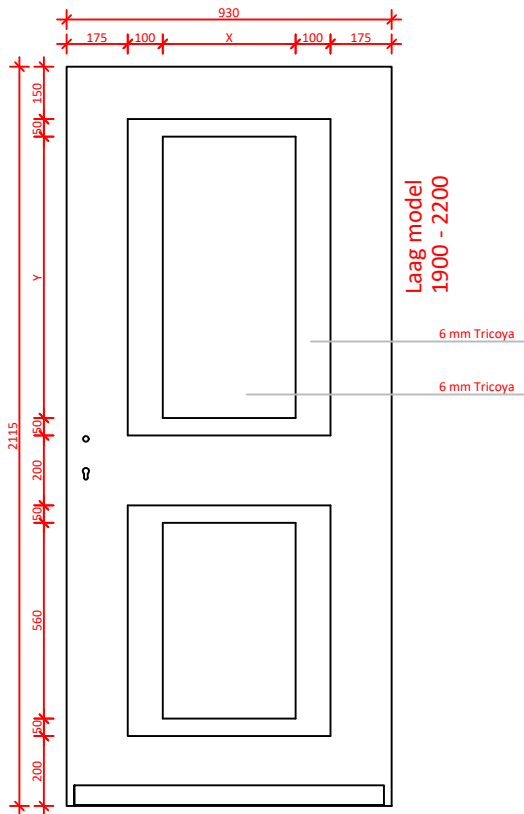

DATUM:	GEWIJZIGD:	CALCULATIENR:	TEKENINGNR:	MODEL: 9406	HOUTSOORT:
--------	------------	---------------	-------------	----------------	------------

	KLANT/PROJECT: overzicht modellen 9406			DCM NUMMER:
--	---	--	--	-------------

AANVRAAG:	SCHAAL:	GETEKEND: MN	LEVERWEEK:	1.2a P.34
-----------	---------	-----------------	------------	-----------

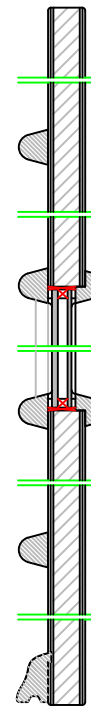
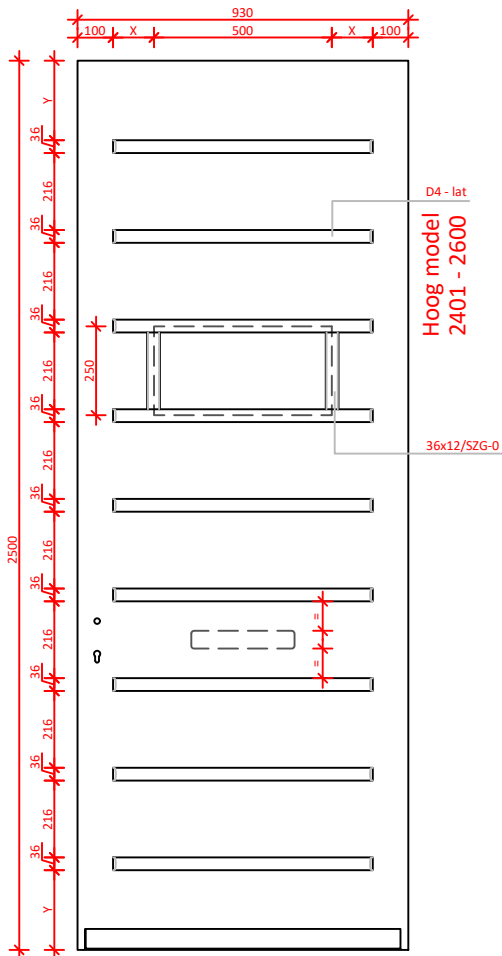
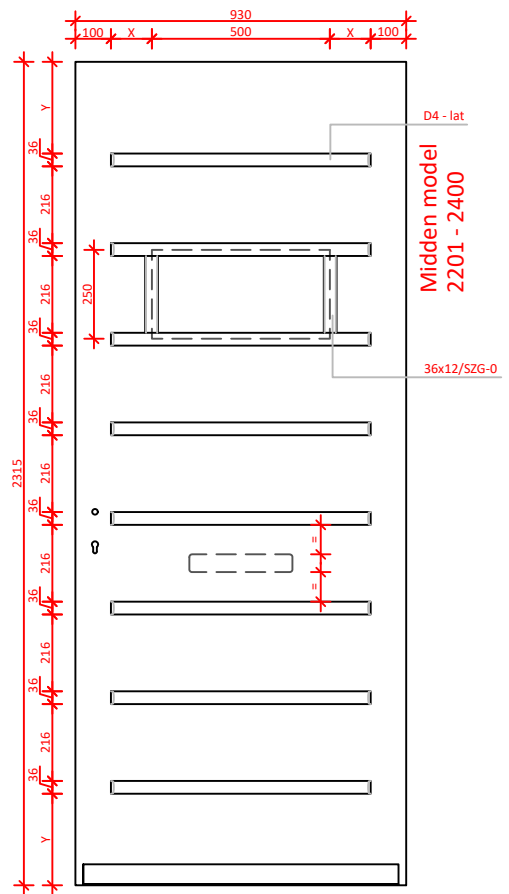
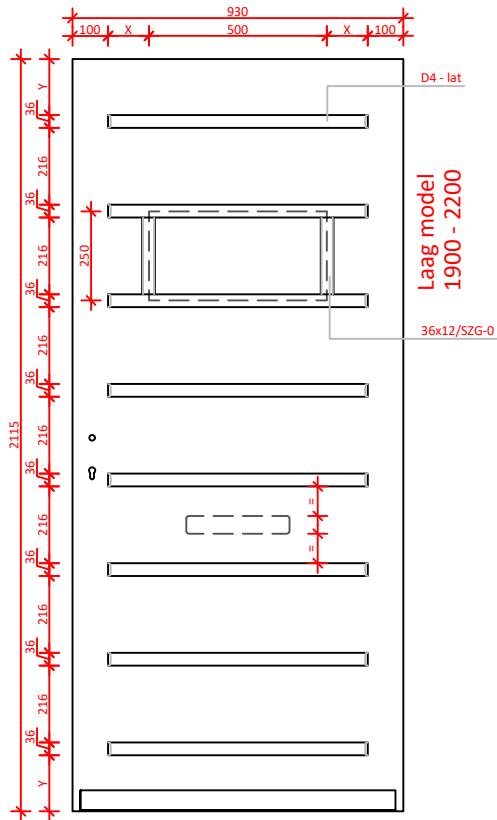

Strakke SponningMaat
 Pasmaat deurbreedte t/m 1000 mm : SSM 500mm
 Pasmaat deurbreedte 1001 t/m 1100 mm : SSM 600mm
 Pasmaat deurbreedte > 1101 mm : SSM 700mm

DATUM:	GEWIJZIGD:	CALCULATIENR:	TEKENINGNR:	MODEL: 9431N	HOUTSOORT:
--------	------------	---------------	-------------	-----------------	------------

	KLANT/PROJECT: overzicht modellen 9431N			DCM NUMMER:
--	--	--	--	-------------

AANVRAAG:	SCHAAL:	GETEKEND: MN	LEVERWEEK: 1.2a P.35
-----------	---------	-----------------	-------------------------

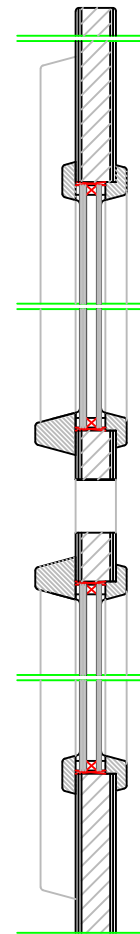
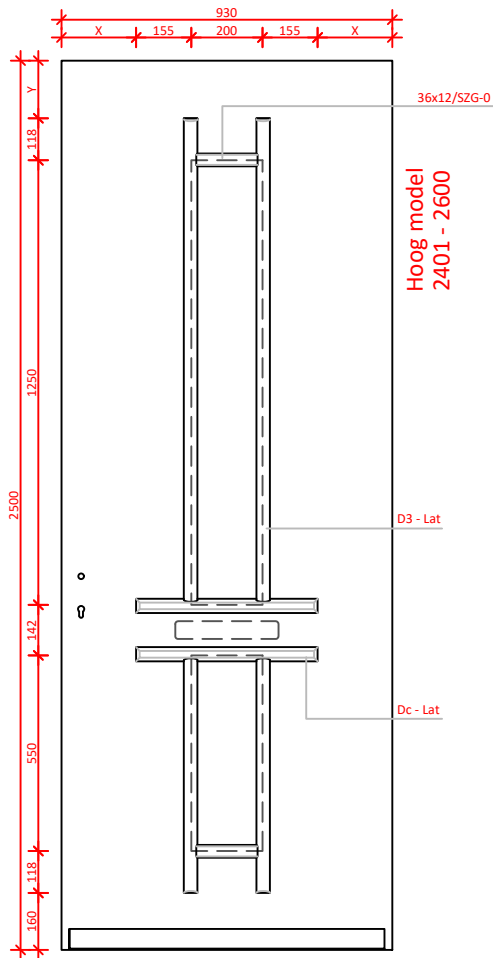
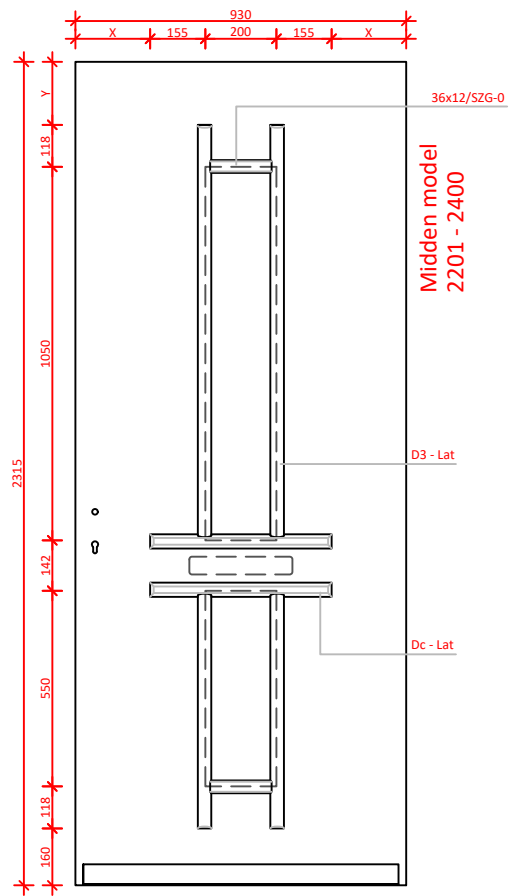
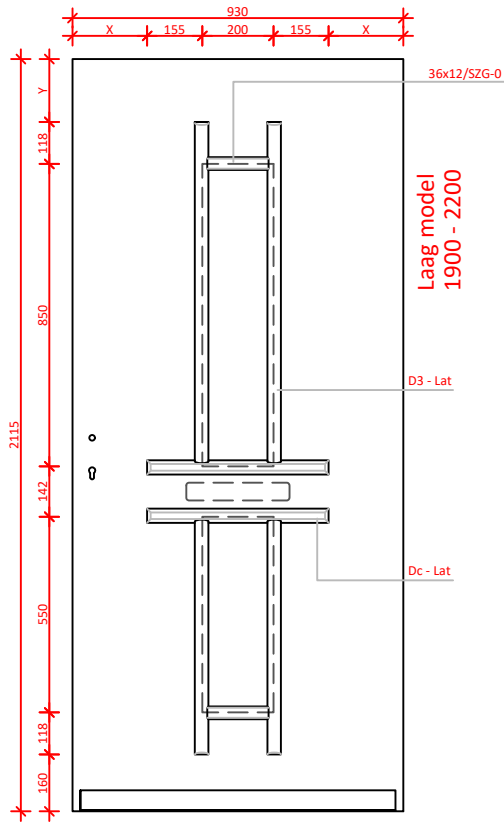

DATUM:	GEWIJZIGD:	CALCULATIENR:	TEKENINGNR:	MODEL: 9432N	HOUTSOORT:
--------	------------	---------------	-------------	-----------------	------------

KEGRO DEUREN	KLANT/PROJECT: overzicht modellen 9432N			DCM NUMMER:
-----------------------	--	--	--	-------------

AANVRAAG:	SCHAAL:	GETEKEND: MN	LEVERWEEK: 1.2a P.36
-----------	---------	-----------------	-------------------------

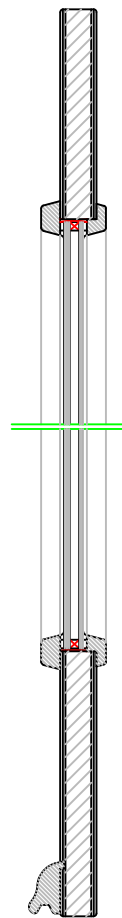
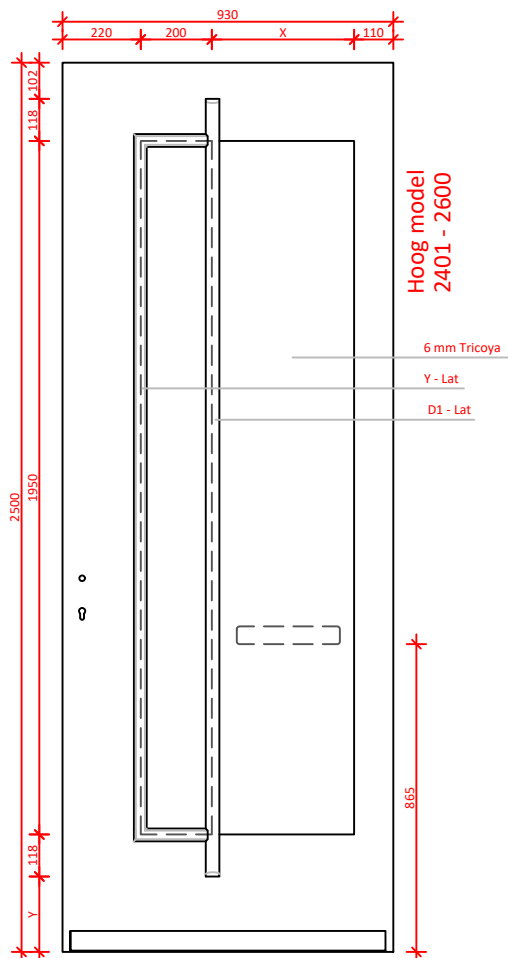
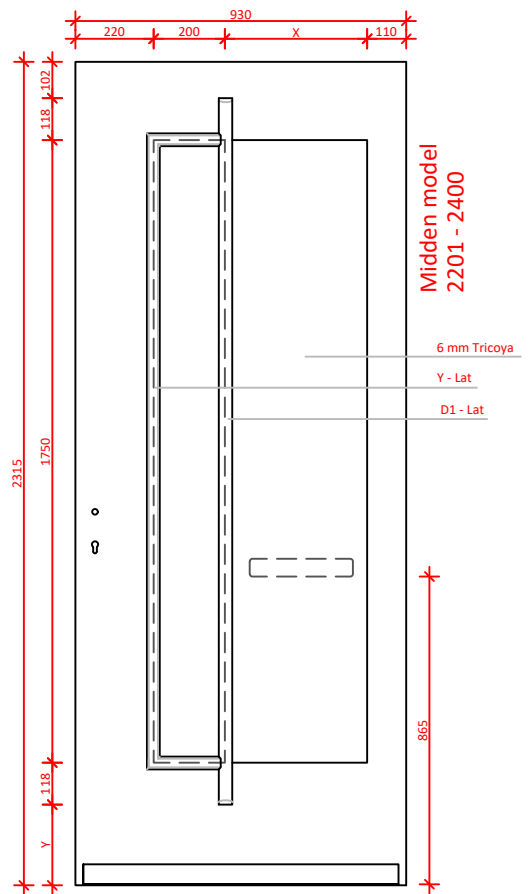
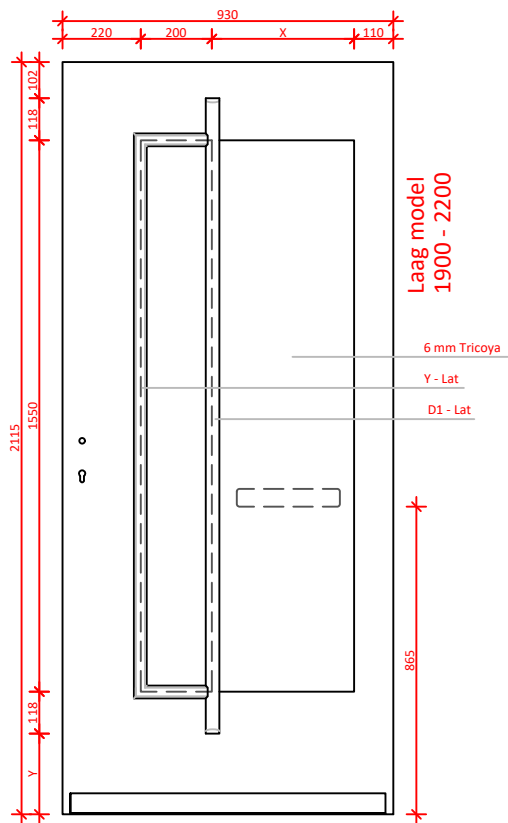

DATUM:	GEWIJZIGD:	CALCULATIENR:	TEKENINGNR:	MODEL: 9433N	HOUTSOORT:
--------	------------	---------------	-------------	-----------------	------------

KEGRO DEUREN	KLANT/PROJECT: overzicht modellen 9433N L1 - R4			DCM NUMMER:
-----------------------	--	--	--	-------------

AANVRAAG:	SCHAAL:	GETEKEND: MN	LEVERWEEK: 1.2a P.37
-----------	---------	-----------------	-------------------------

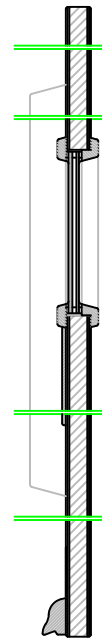
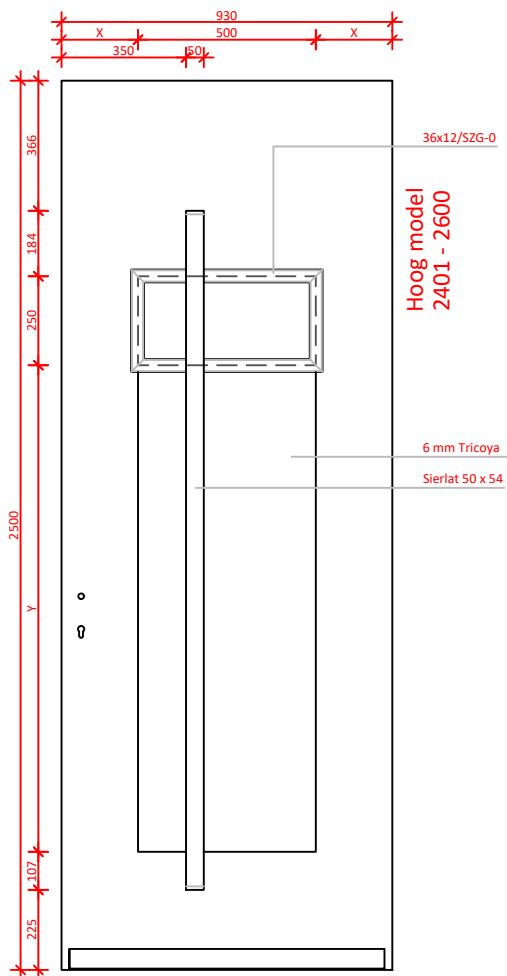
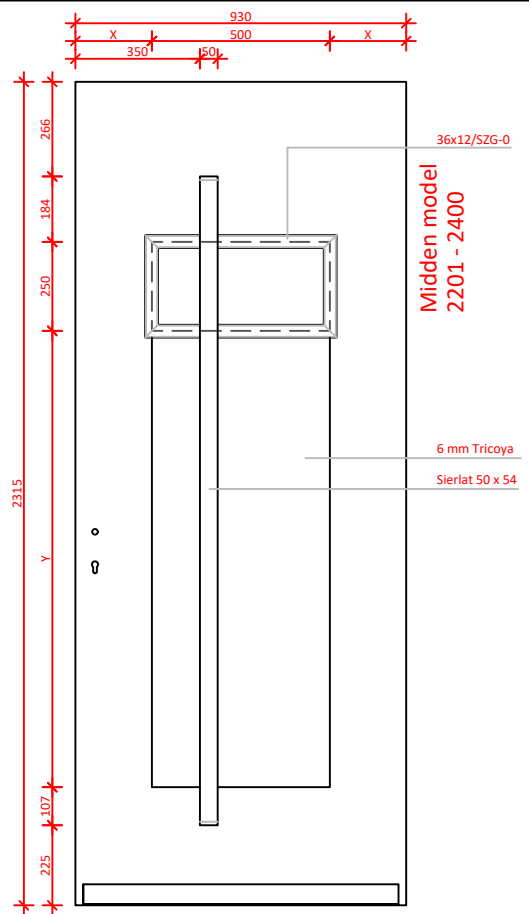
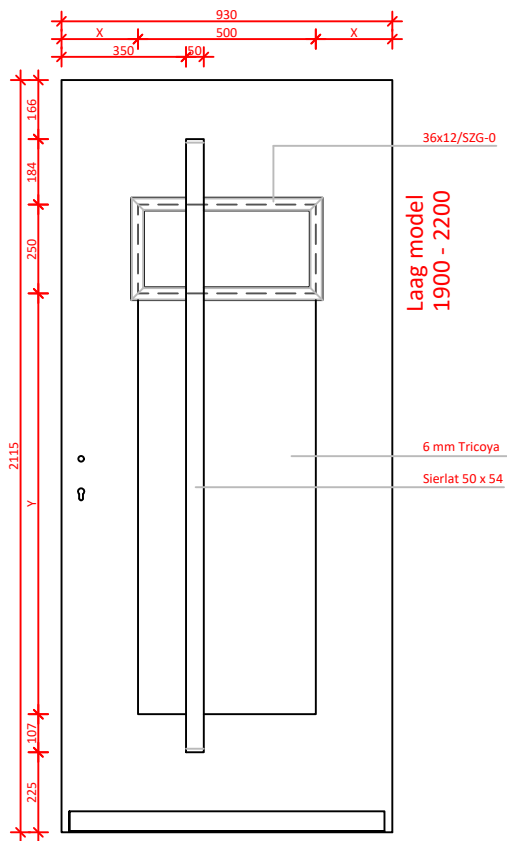

Strakke SponningMaat

- Pasmaat deurbreedte t/m 1000 mm : SSM 500mm
- Pasmaat deurbreedte 1001 t/m 1100 mm : SSM 600mm
- Pasmaat deurbreedte > 1101 mm : SSM 700mm

DATUM:	GEWIJZIGD:	CALCULATIENR:	TEKENINGNR:	MODEL: 9434N	HOUTSOORT:
--------	------------	---------------	-------------	-----------------	------------

KEGRO DEUREN	KLANT/PROJECT: overzicht modellen 9434N L1 - R4			DCM NUMMER:
-----------------------	--	--	--	-------------

AANVRAAG:	SCHAAL:	GETEKEND: MN	LEVERWEEK: 1.2a P.38
-----------	---------	-----------------	-------------------------

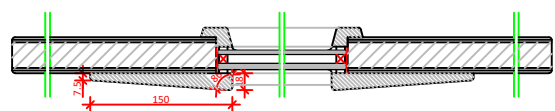
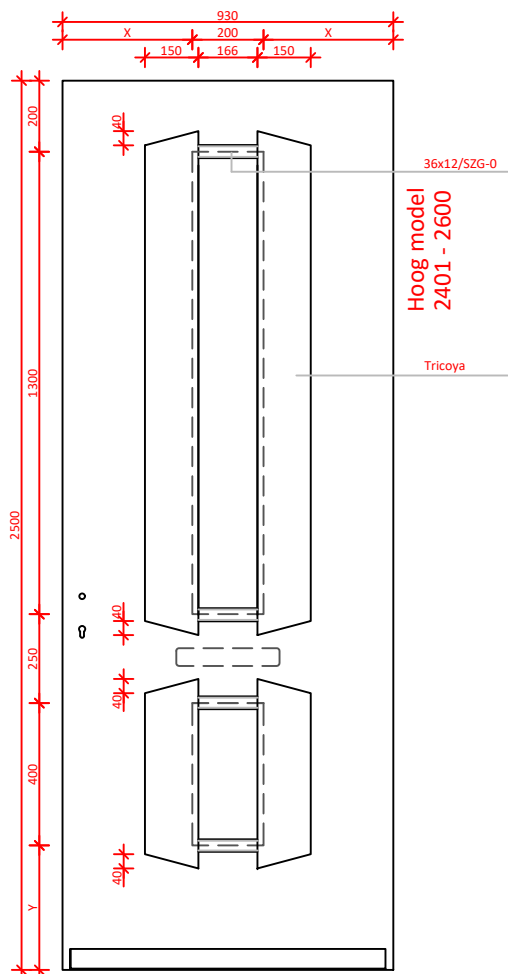
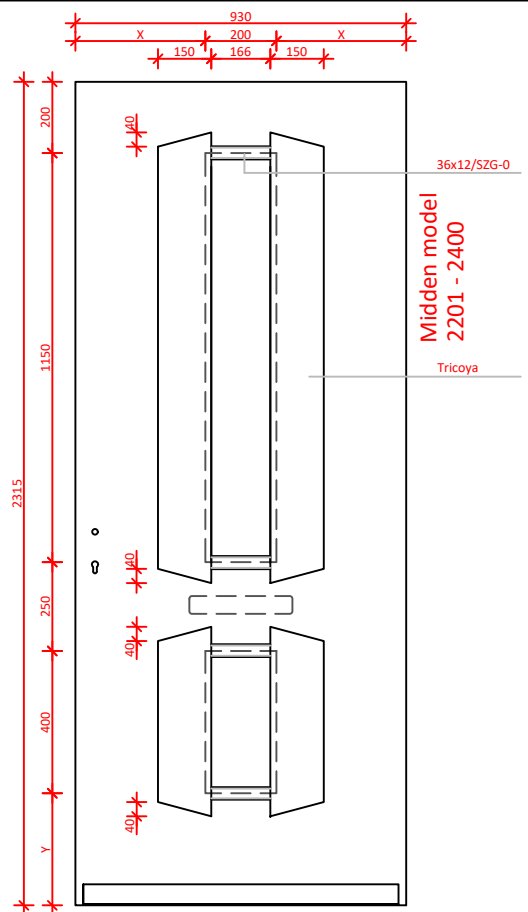
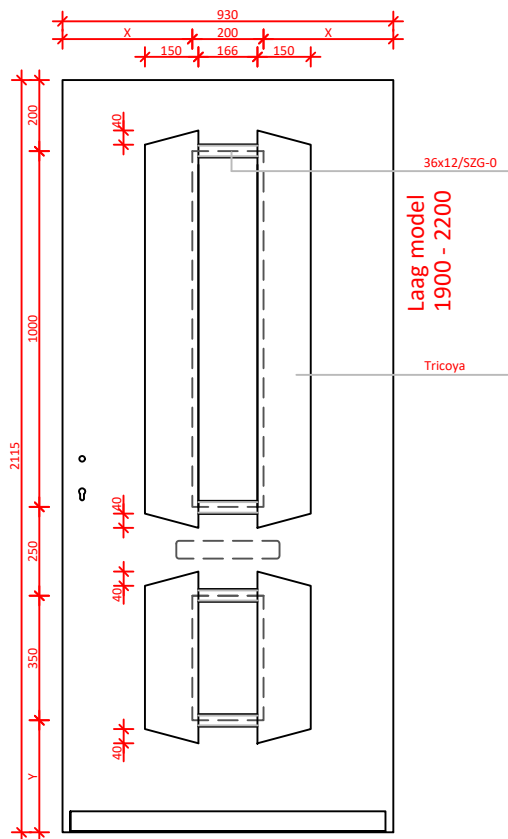

DATUM:	GEWIJZIGD:	CALCULATIENR:	TEKENINGNR:	MODEL: 9435N	HOUTSOORT:
--------	------------	---------------	-------------	-----------------	------------

	KLANT/PROJECT: overzicht modellen 9435N			DCM NUMMER:
--	--	--	--	-------------

AANVRAAG:	SCHAAL:	GETEKEND: MN	LEVERWEEK: 1.2a P.39
-----------	---------	-----------------	-------------------------

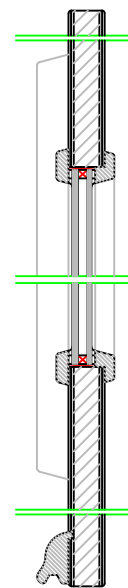
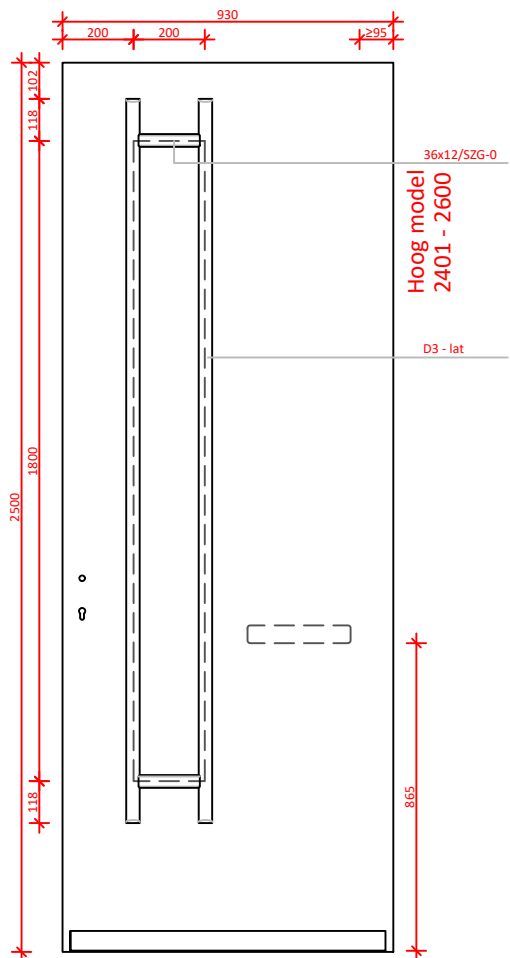
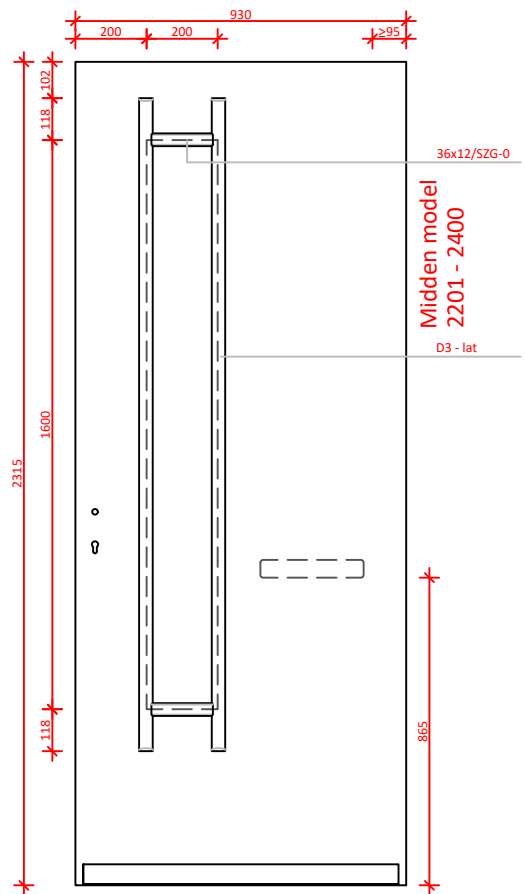
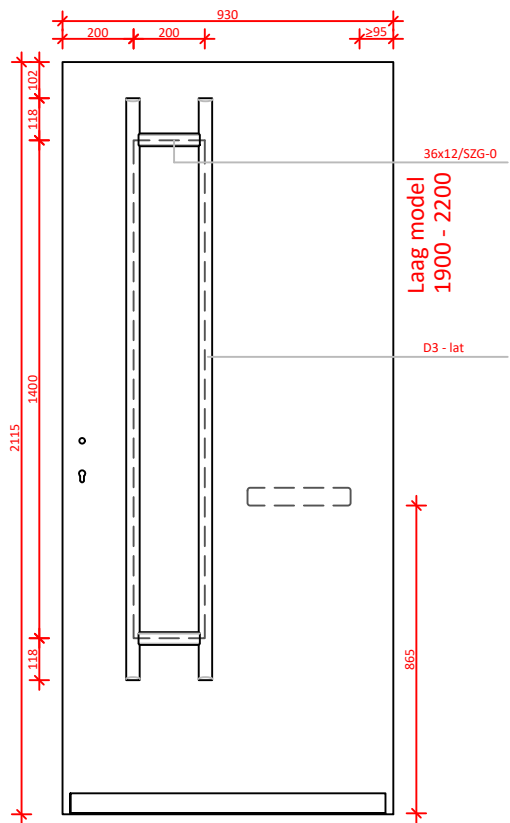

DATUM:	GEWIJZIGD:	CALCULATIENR:	TEKENINGNR:	MODEL: 9436N	HOUTSOORT:
--------	------------	---------------	-------------	-----------------	------------

	KLANT/PROJECT: overzicht modellen 9436N			DCM NUMMER:
--	--	--	--	-------------

AANVRAAG:	SCHAAL:	GETEKEND: MN	LEVERWEEK:	1.2a P.40
-----------	---------	-----------------	------------	-----------

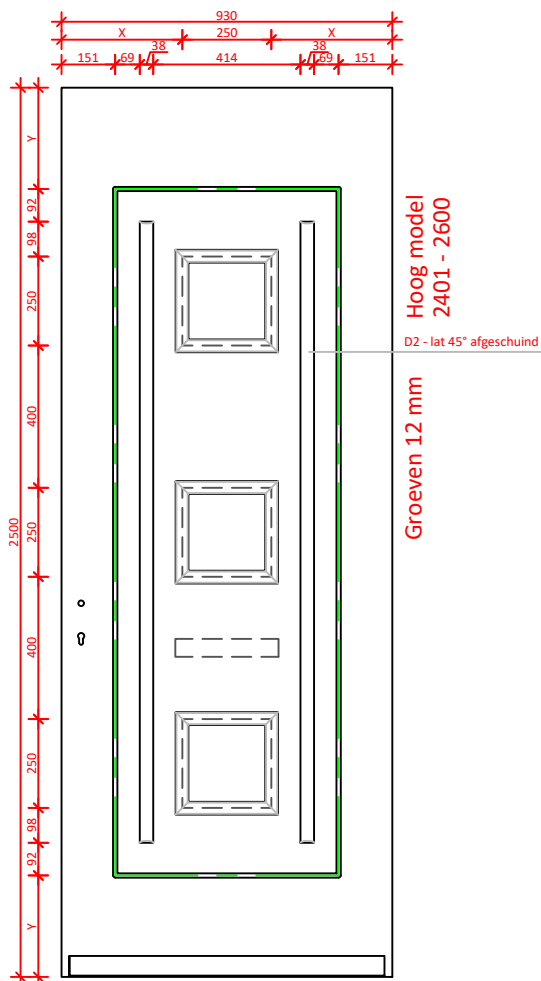
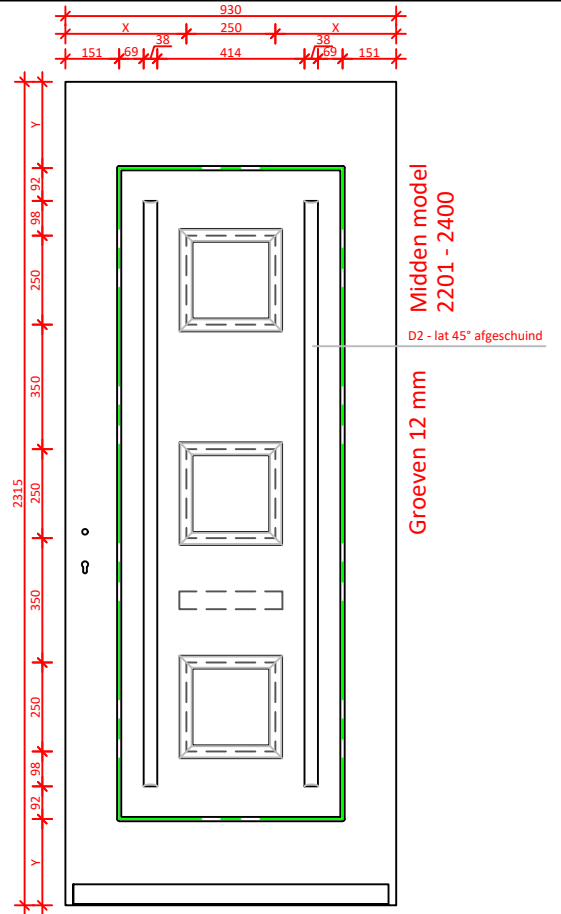
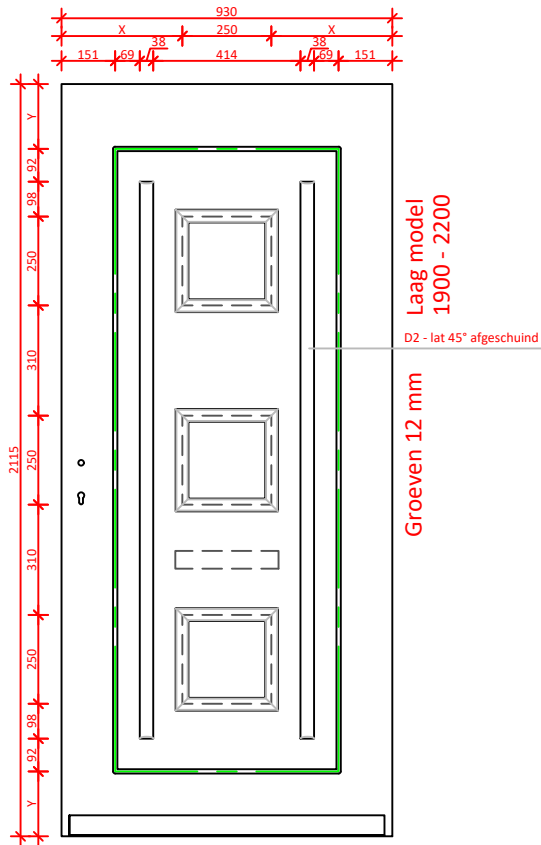

DATUM:	GEWIJZIGD:	CALCULATIENR:	TEKENINGNR:	MODEL: 9460N	HOUTSOORT:
--------	------------	---------------	-------------	-----------------	------------

	KLANT/PROJECT: overzicht modellen 9460N			DCM NUMMER:
--	--	--	--	-------------

AANVRAAG:	SCHAAL:	GETEKEND: MN	LEVERWEEK: 1.2a P.41
-----------	---------	-----------------	-------------------------

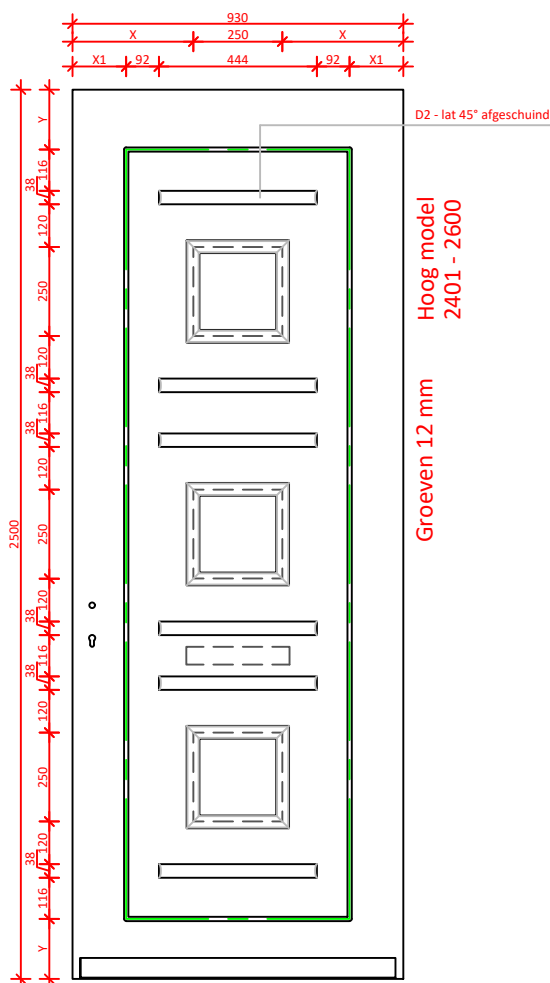
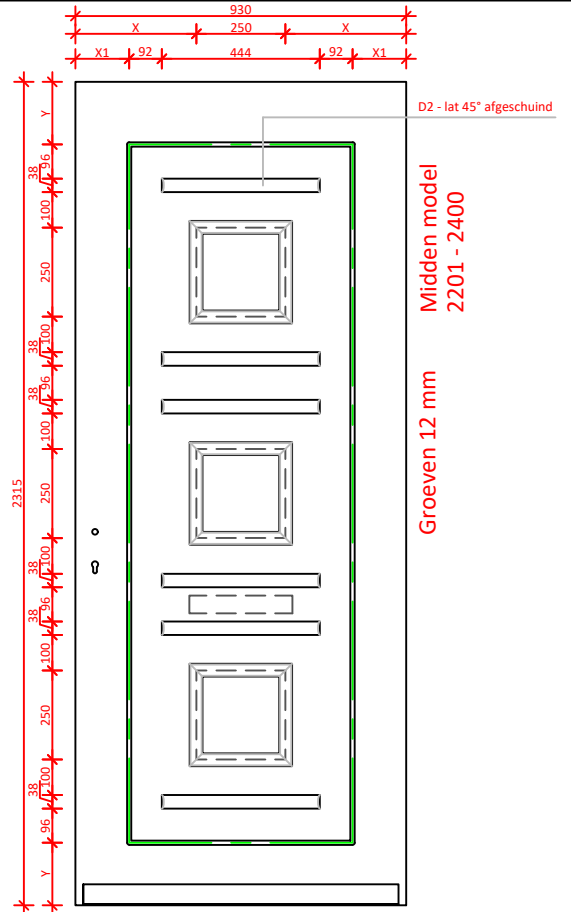
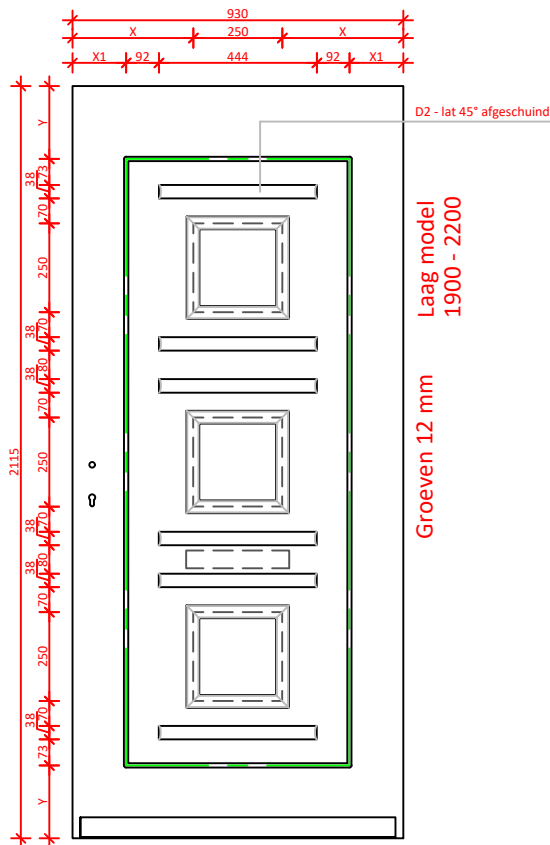

DATUM:	GEWIJZIGD:	CALCULATIENR:	TEKENINGNR:	MODEL: 9461N	HOUTSOORT:
--------	------------	---------------	-------------	-----------------	------------

	KLANT/PROJECT: overzicht modellen 9461N			DCM NUMMER:
--	--	--	--	-------------

AANVRAAG:	SCHAAL:	GETEKEND: MN	LEVERWEEK:	1.2a P.42
-----------	---------	-----------------	------------	-----------

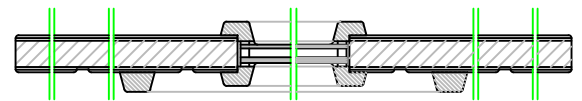
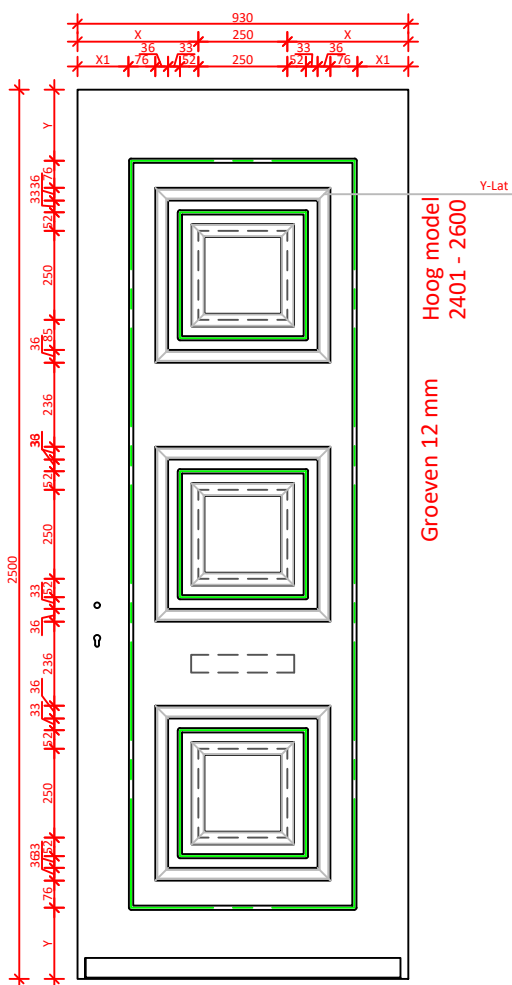
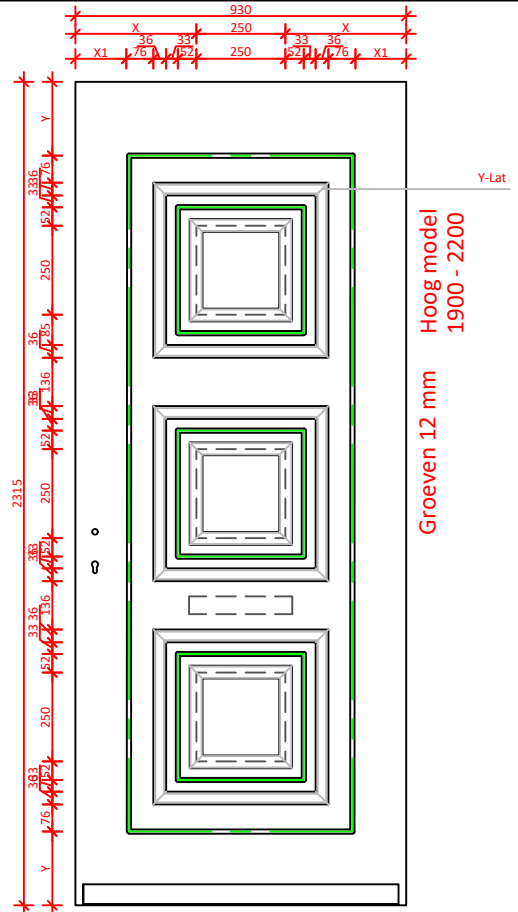
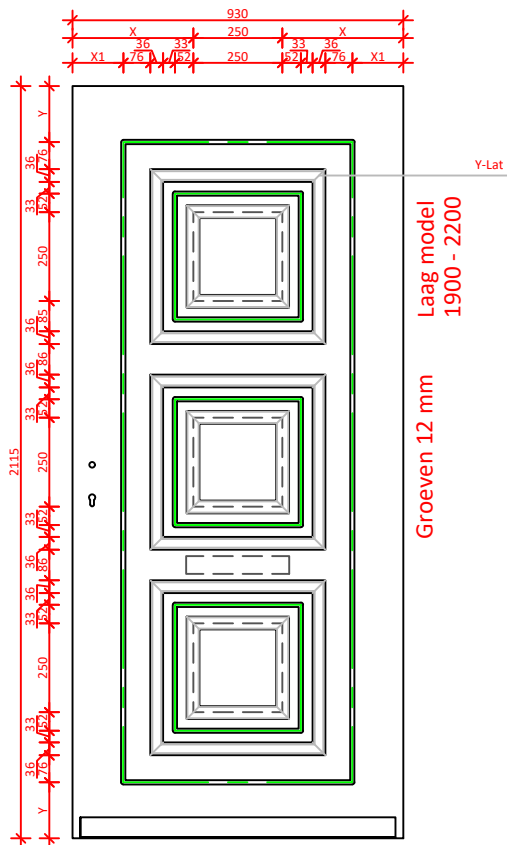

DATUM:	GEWIJZIGD:	CALCULATIENR:	TEKENINGNR:	MODEL: 9462N	HOUTSOORT:
--------	------------	---------------	-------------	-----------------	------------

KEGRO DEUREN	KLANT/PROJECT: overzicht modellen 9462N			DCM NUMMER:
-----------------------	--	--	--	-------------

AANVRAAG:	SCHAAL:	GETEKEND: MN	LEVERWEEK:	1.2a P.43
-----------	---------	-----------------	------------	-----------

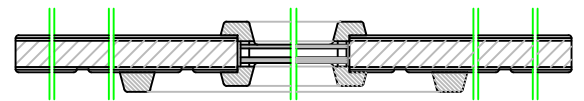
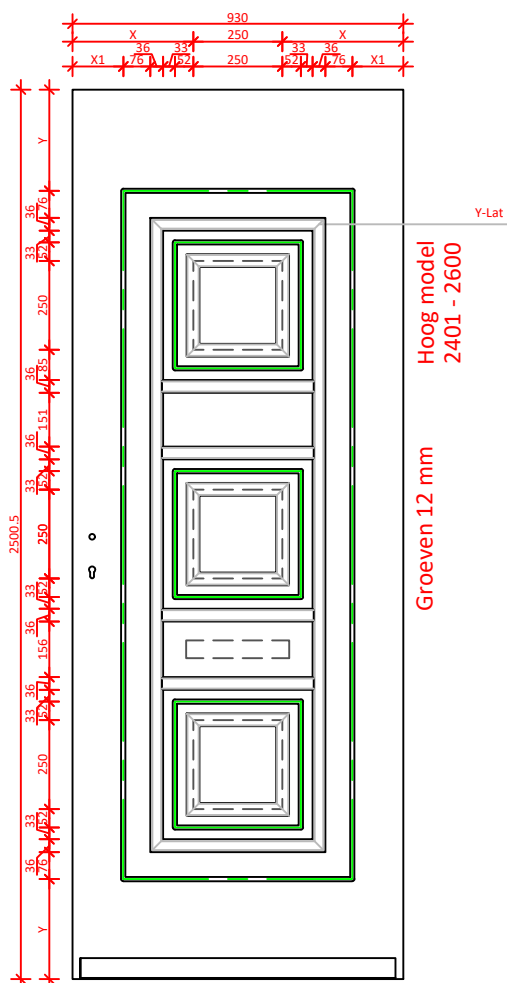
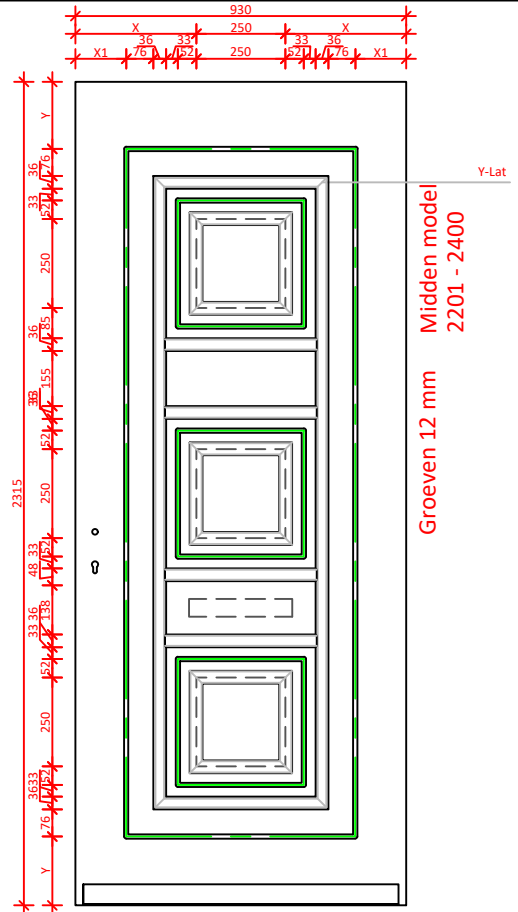
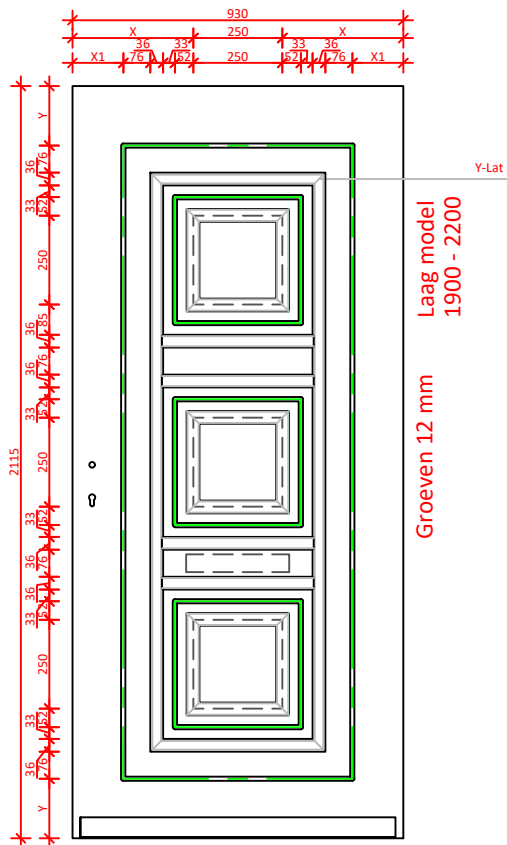

DATUM:	GEWIJZIGD:	CALCULATIENR:	TEKENINGNR:	MODEL: 9463N	HOUTSOORT:
--------	------------	---------------	-------------	-----------------	------------

	KLANT/PROJECT: overzicht modellen 9463N			DCM NUMMER:
--	--	--	--	-------------

AANVRAAG:	SCHAAL:	GETEKEND: MN	LEVERWEEK:	1.2a P.44
-----------	---------	-----------------	------------	-----------

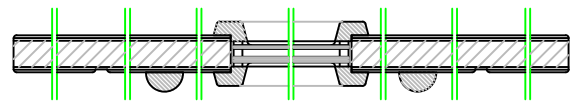
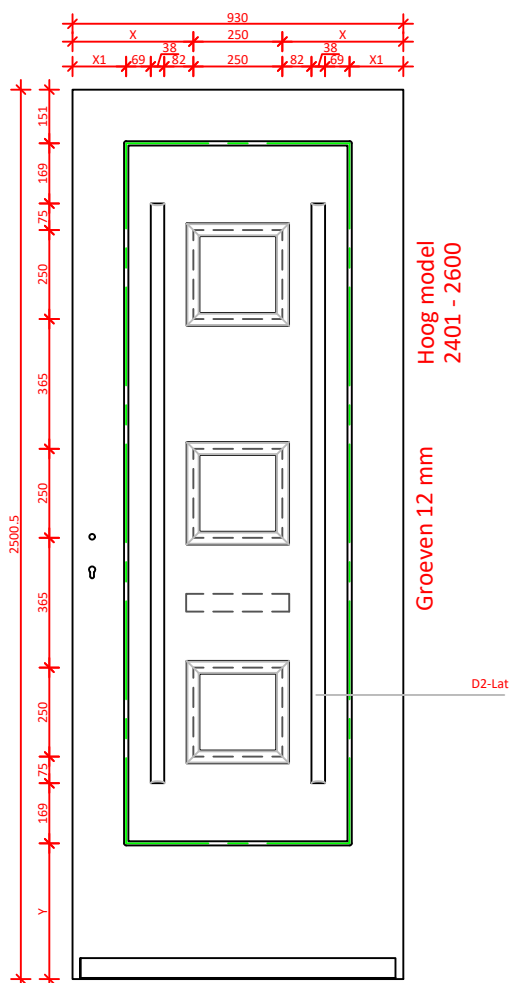
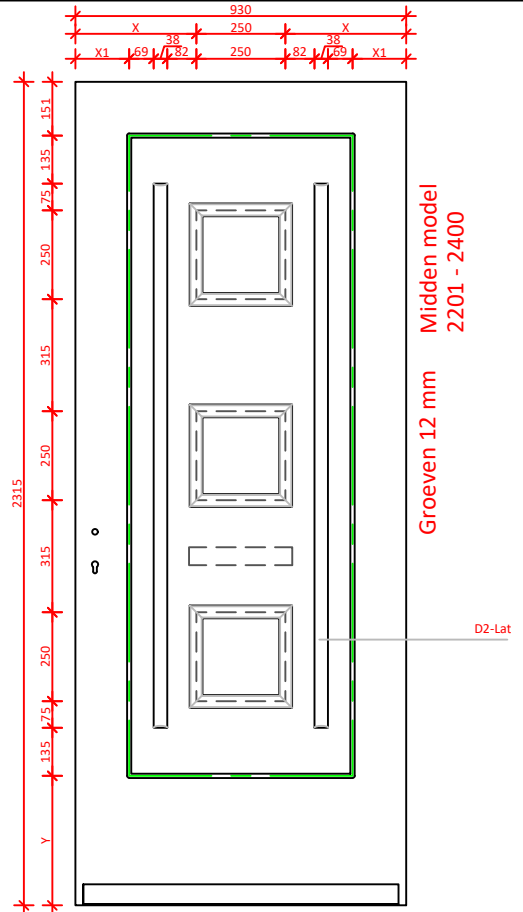
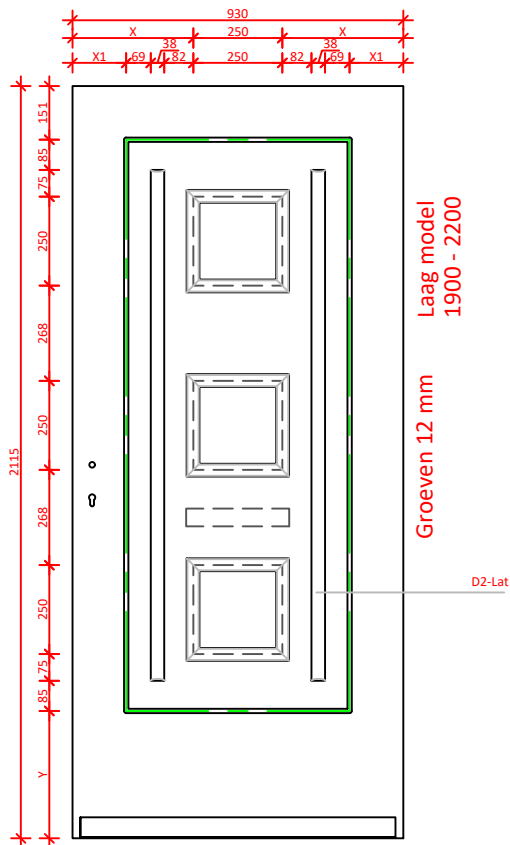

DATUM:	GEWIJZIGD:	CALCULATIENR:	TEKENINGNR:	MODEL: 9464N	HOUTSOORT:
--------	------------	---------------	-------------	-----------------	------------

	KLANT/PROJECT: overzicht modellen 9464N			DCM NUMMER:
--	--	--	--	-------------

AANVRAAG:	SCHAAL:	GETEKEND: MN	LEVERWEEK:	1.2a P.45
-----------	---------	-----------------	------------	-----------

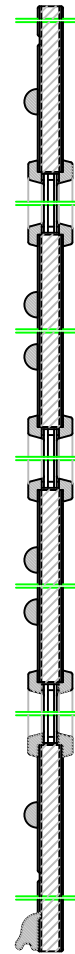
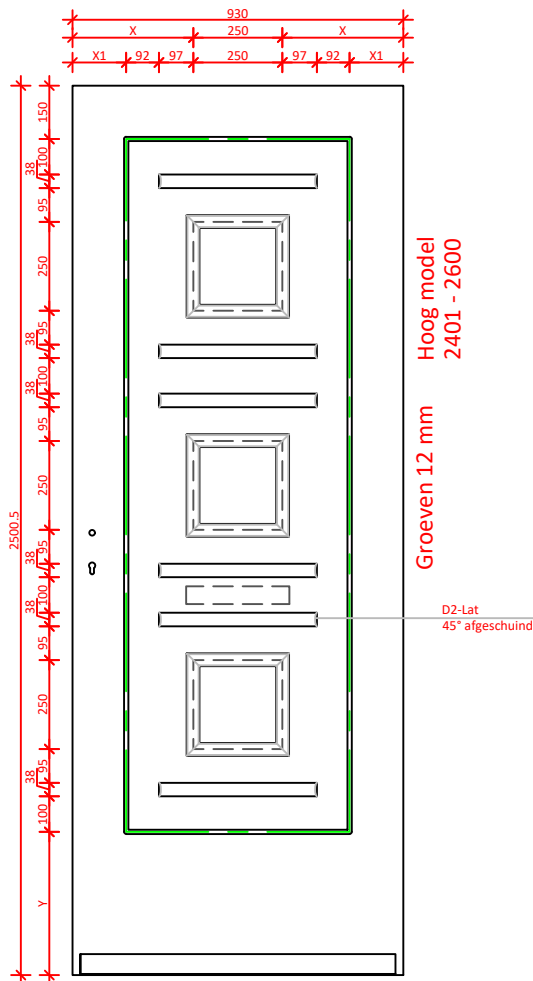
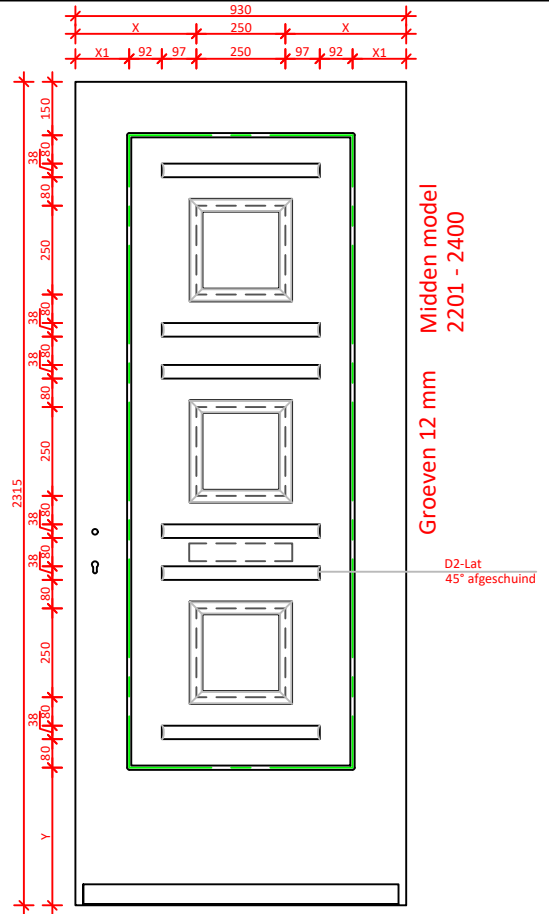
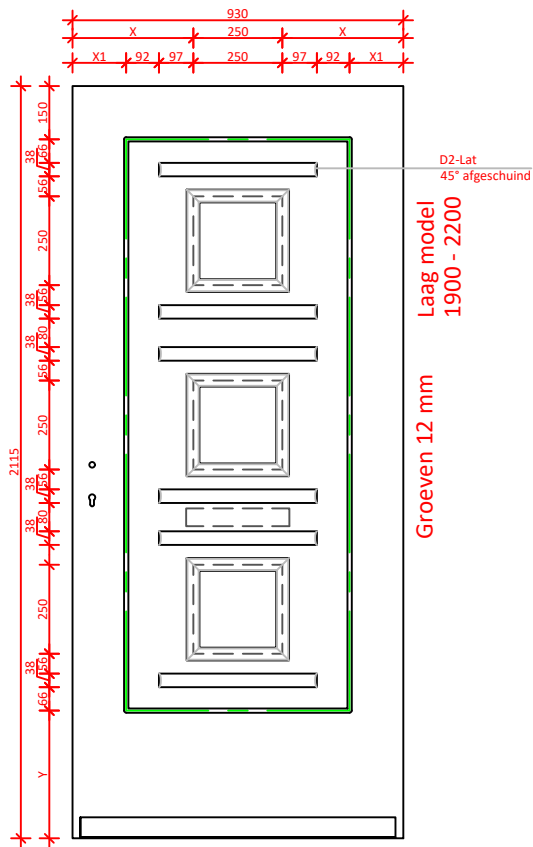

DATUM:	GEWIJZIGD:	CALCULATIENR:	TEKENINGNR:	MODEL: 9465N	HOUTSOORT:
--------	------------	---------------	-------------	-----------------	------------

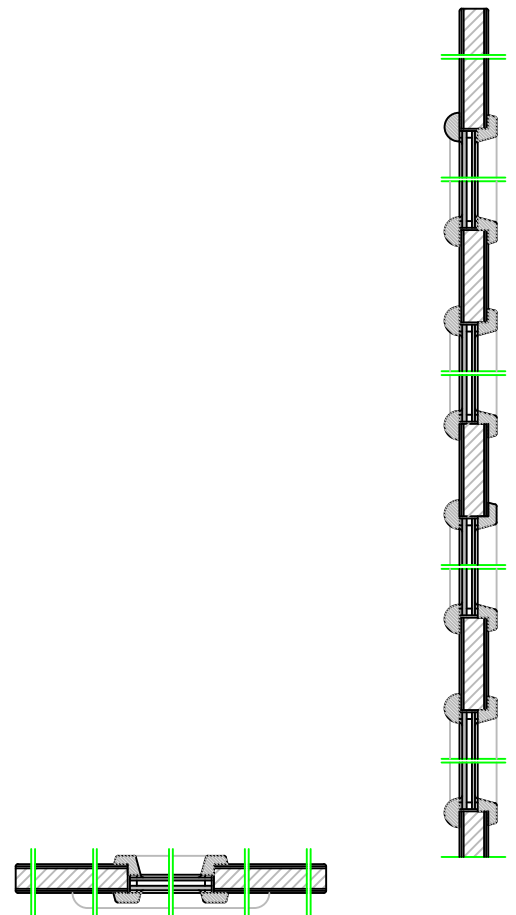
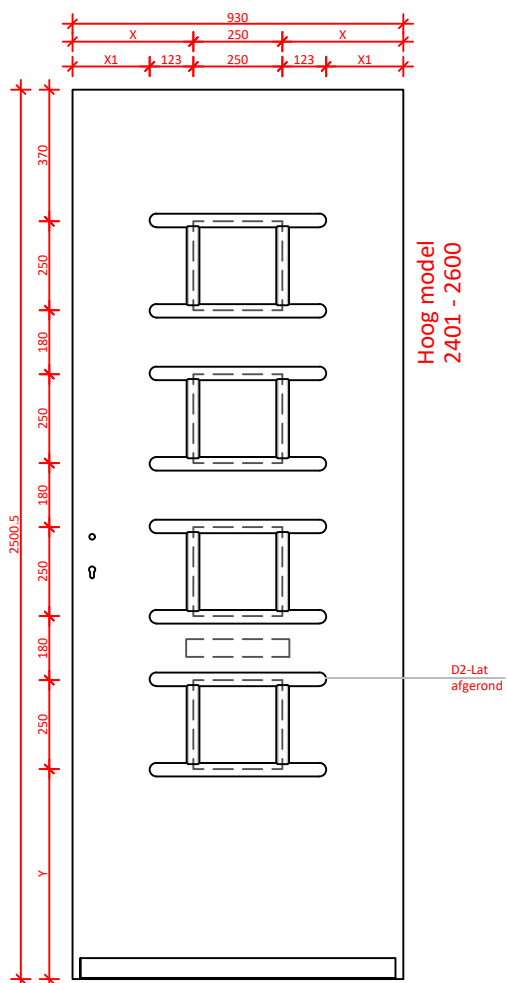
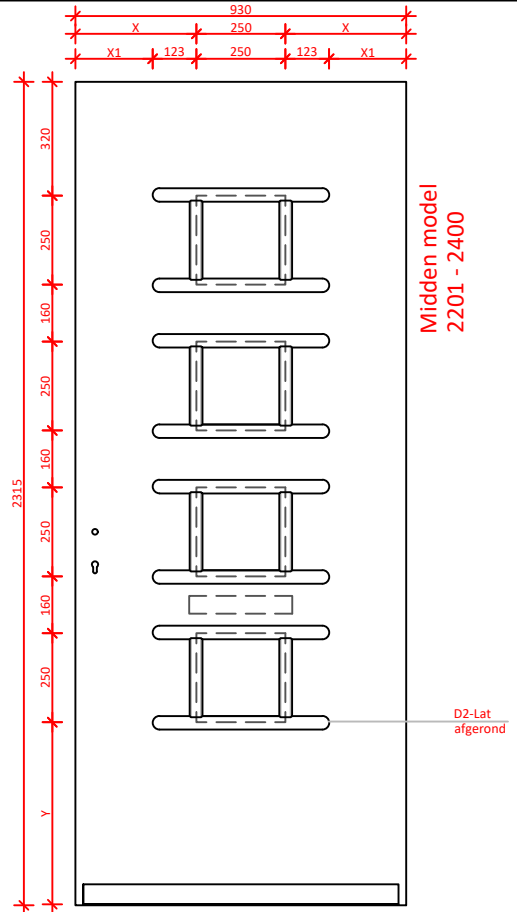
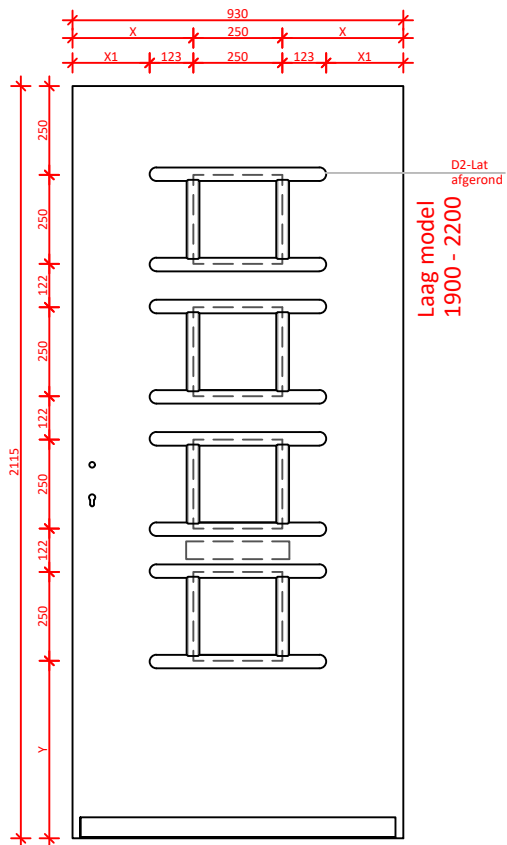

DATUM:	GEWIJZIGD:	CALCULATIENR:	TEKENINGNR:	MODEL: 9466N	HOUTSOORT:
--------	------------	---------------	-------------	-----------------	------------

	KLANT/PROJECT: overzicht modellen 9466N			DCM NUMMER:
--	--	--	--	-------------

AANVRAAG:	SCHAAL:	GETEKEND: MN	LEVERWEEK:	1.2a P.47
-----------	---------	-----------------	------------	-----------

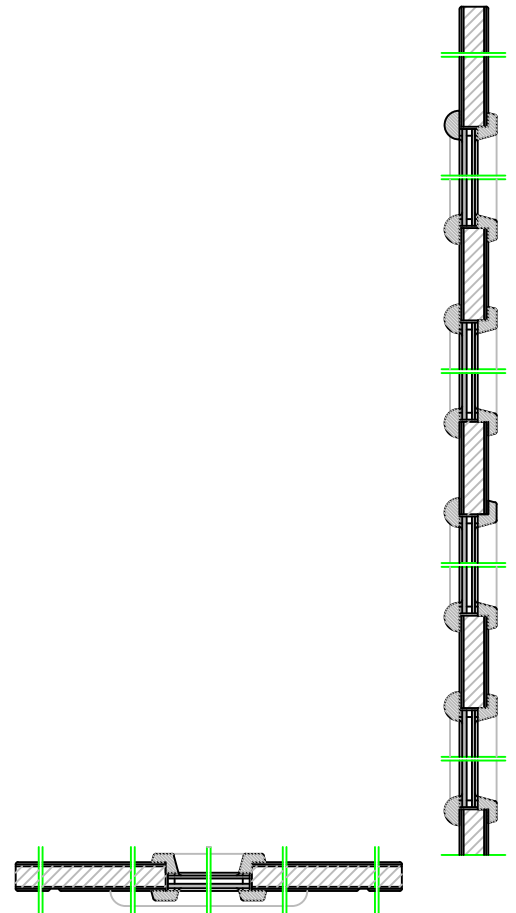
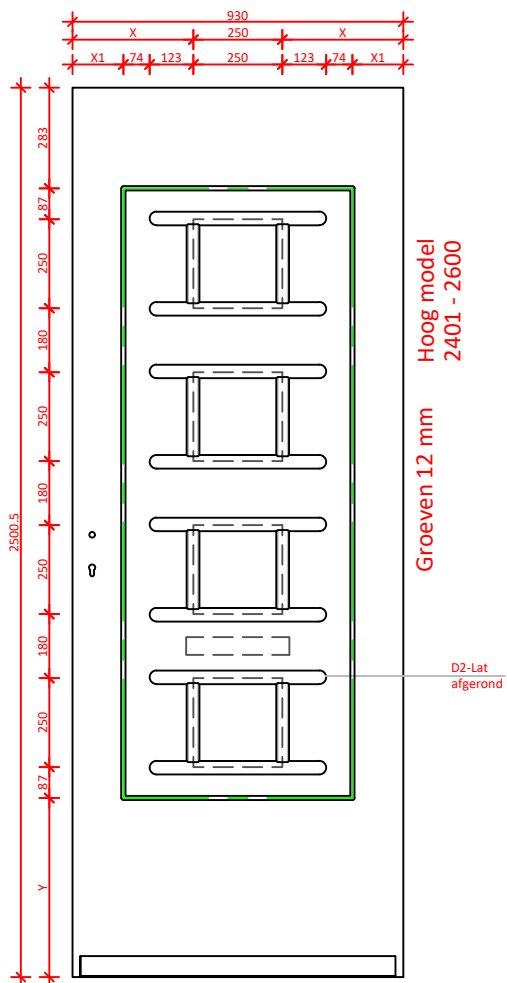
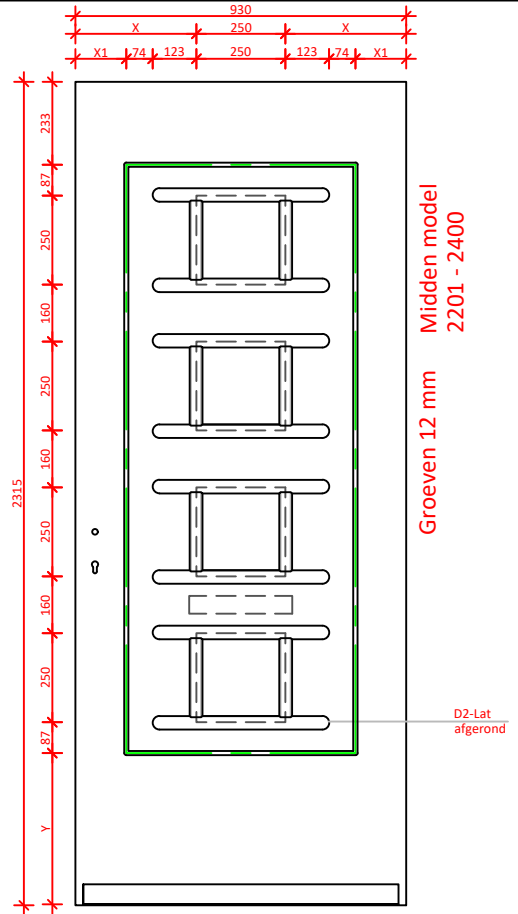
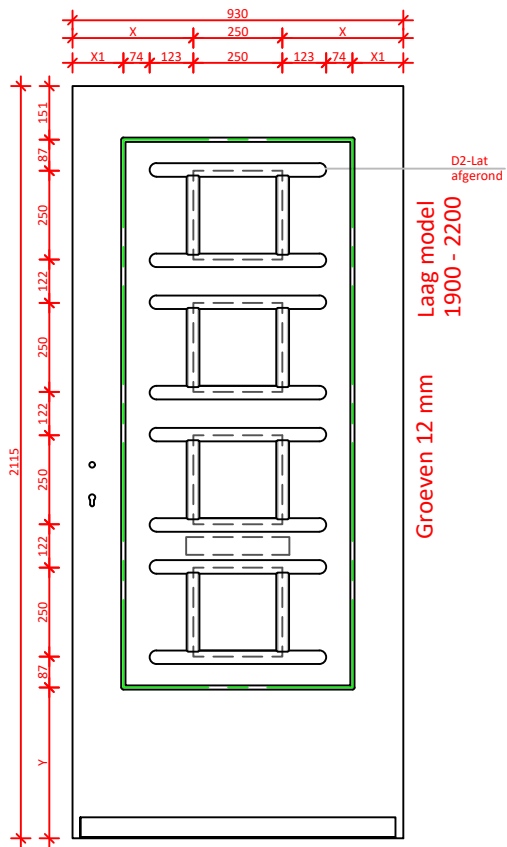

DATUM:	GEWIJZIGD:	CALCULATIENR:	TEKENINGNR:	MODEL: 9467N	HOUTSOORT:
--------	------------	---------------	-------------	-----------------	------------

	KLANT/PROJECT: overzicht modellen 9467N			DCM NUMMER:
--	--	--	--	-------------

AANVRAAG:	SCHAAL:	GETEKEND: MN	LEVERWEEK:	1.2a P.48
-----------	---------	-----------------	------------	-----------

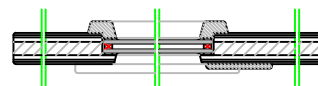
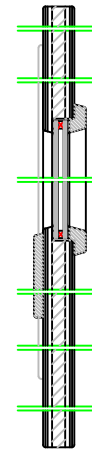
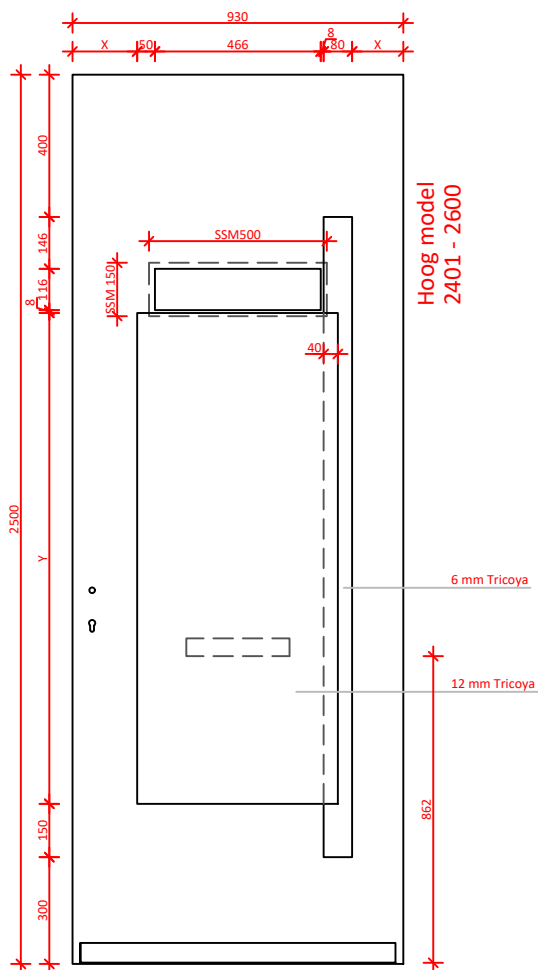
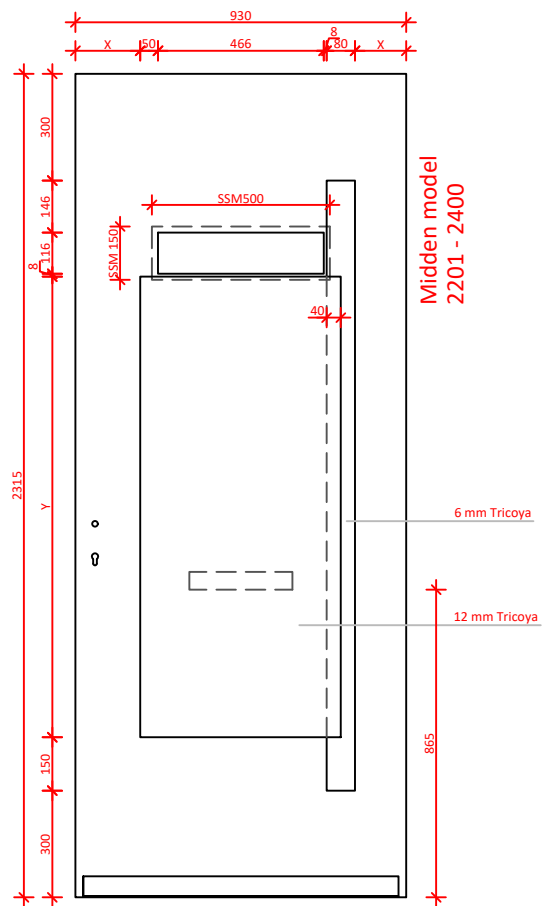
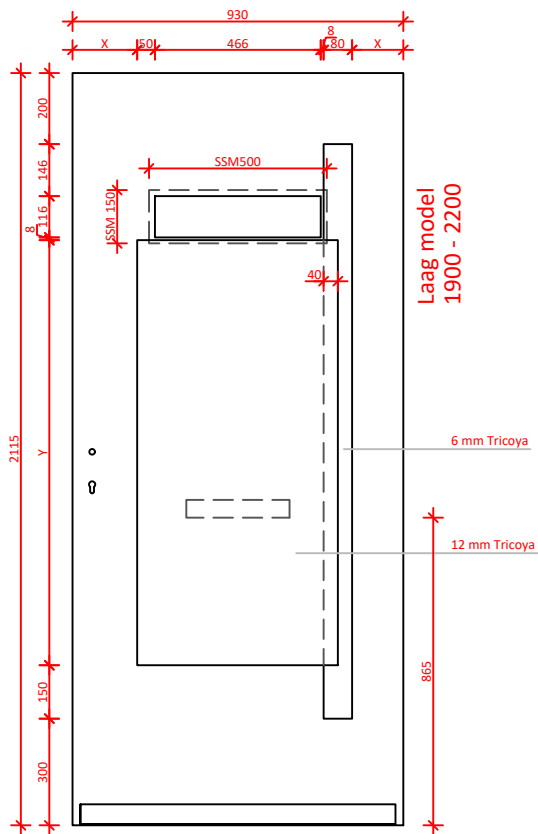

Strakke SponningMaat
 Pasmaat deurbreedte t/m 1000 mm : SSM 500mm
 Pasmaat deurbreedte 1001 t/m 1100 mm : SSM 600mm
 Pasmaat deurbreedte > 1101 mm : SSM 700mm

DATUM:	GEWIJZIGD:	CALCULATIENR:	TEKENINGNR:	MODEL: 9501N	HOUTSOORT:
--------	------------	---------------	-------------	-----------------	------------

	KLANT/PROJECT: overzicht modellen 9501N met briefsleuf			DCM NUMMER:
--	---	--	--	-------------

AANVRAAG:	SCHAAL:	GETEKEND: MN	LEVERWEEK: 1.2a P.49
-----------	---------	-----------------	-------------------------

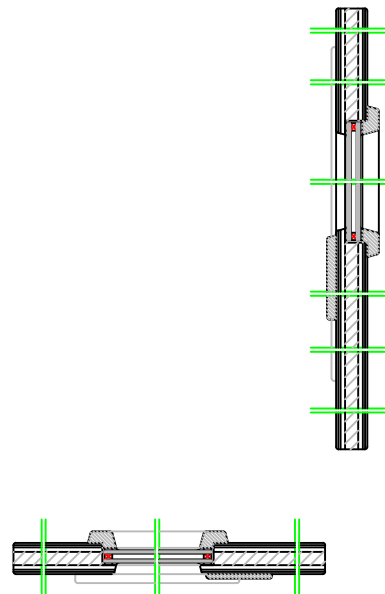
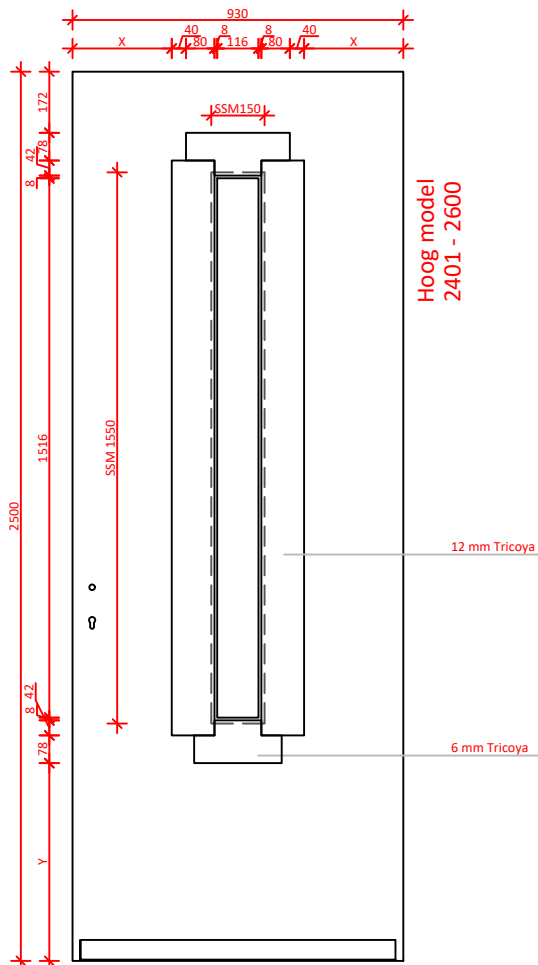
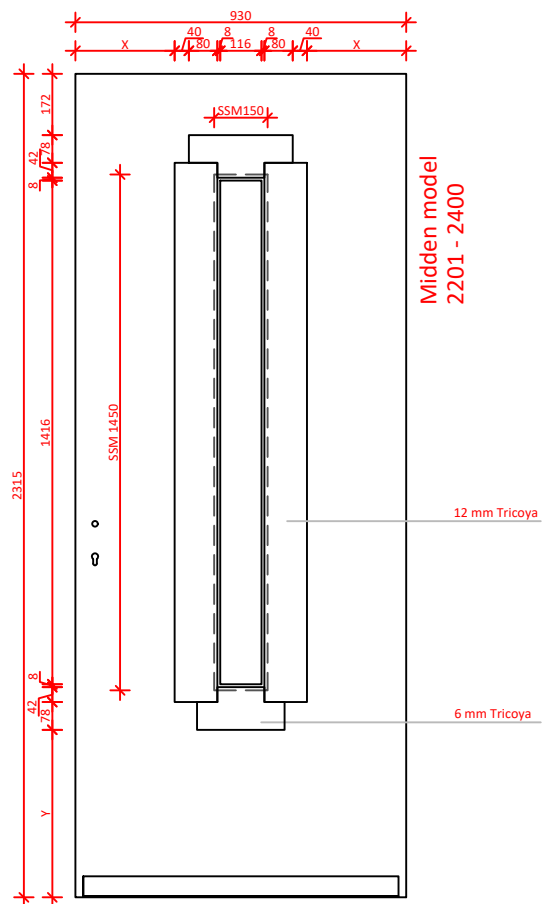
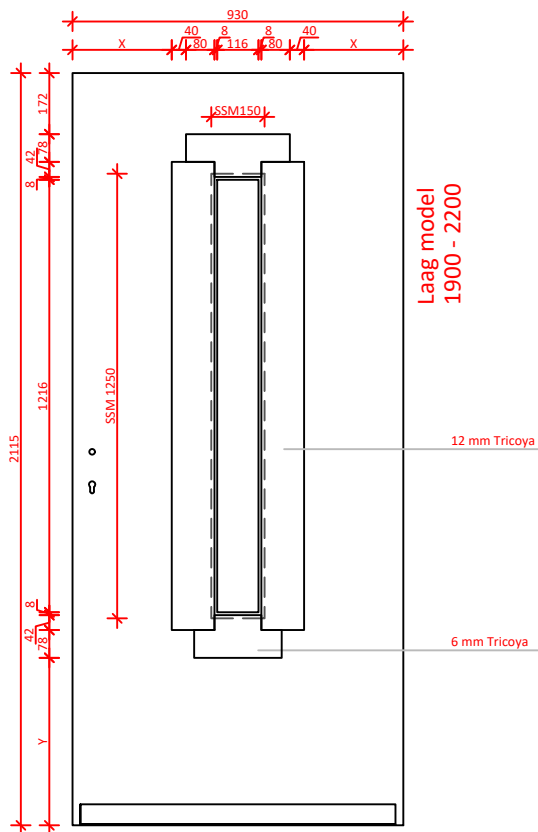

DATUM:	GEWIJZIGD:	CALCULATIENR:	TEKENINGNR:	MODEL: 9502N	HOUTSOORT:
--------	------------	---------------	-------------	-----------------	------------

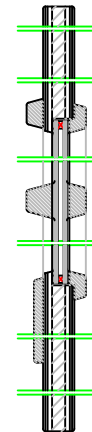
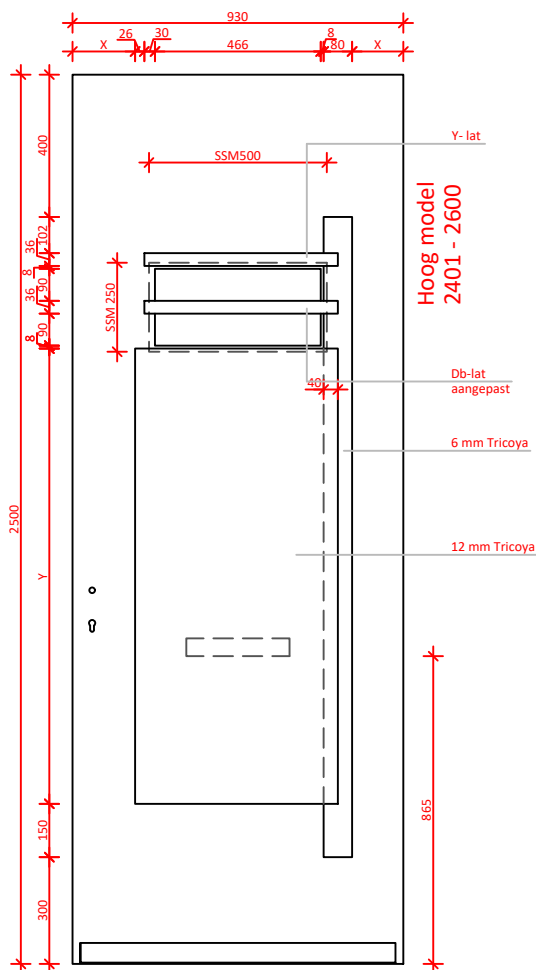
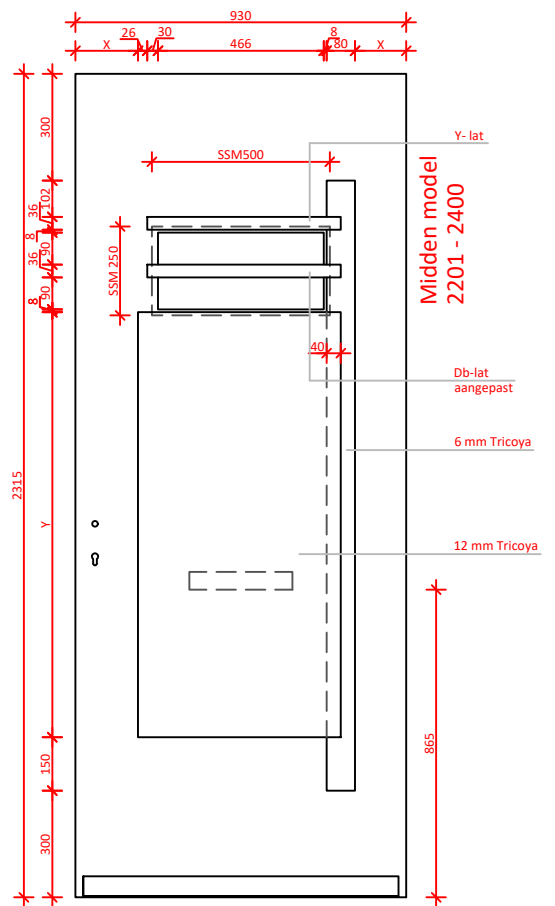
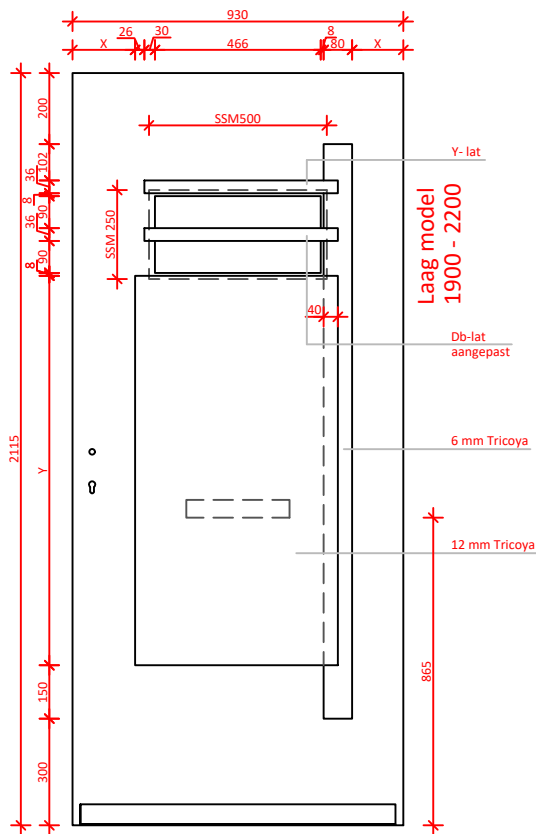

Strakke SponningMaat
 Pasmaat deurbreedte t/m 1000 mm : SSM 500mm
 Pasmaat deurbreedte 1001 t/m 1100 mm : SSM 600mm
 Pasmaat deurbreedte > 1101 mm : SSM 700mm

DATUM:	GEWIJZIGD:	CALCULATIENR:	TEKENINGNR:	MODEL: 9503N	HOUTSOORT:
--------	------------	---------------	-------------	-----------------	------------

	KLANT/PROJECT: overzicht modellen 9503N met briefsleuf			DCM NUMMER:
--	---	--	--	-------------

AANVRAAG:	SCHAAL:	GETEKEND: MN	LEVERWEEK:	1.2a P.51
-----------	---------	-----------------	------------	-----------

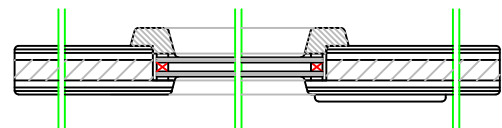
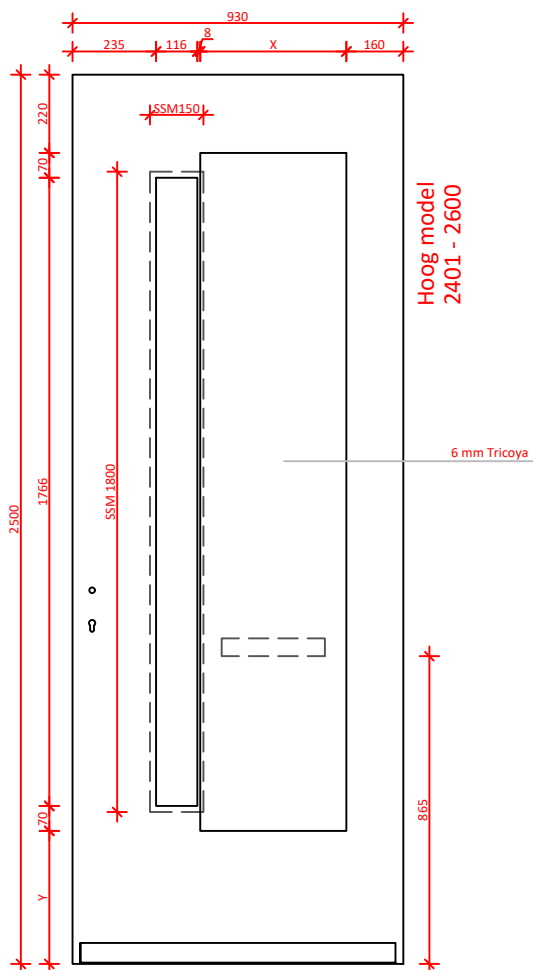
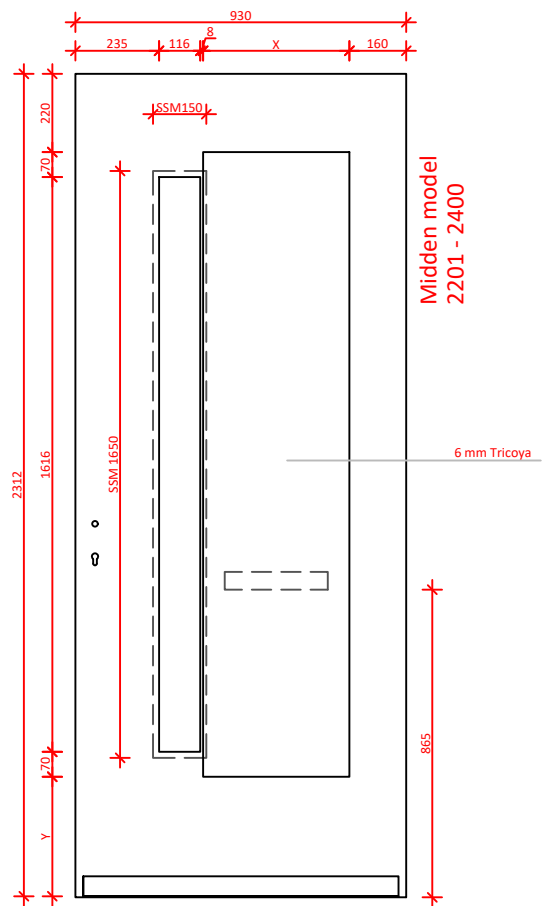
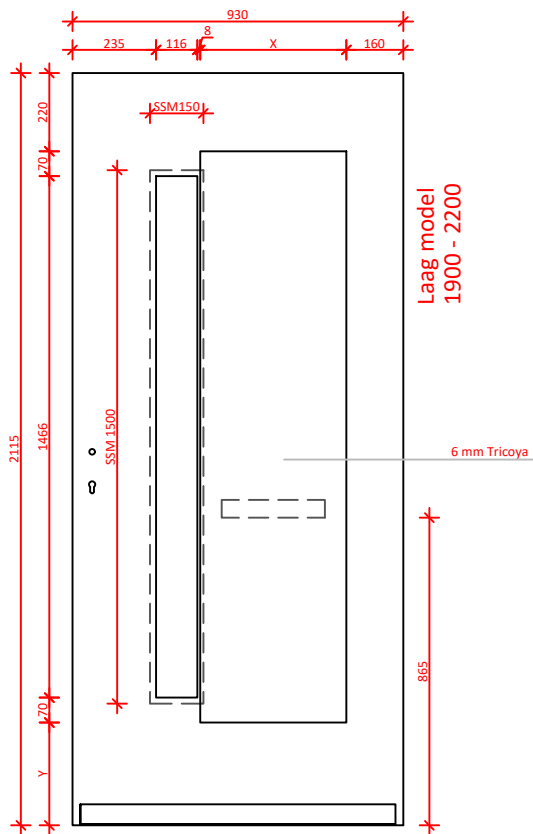

DATUM:	GEWIJZIGD:	CALCULATIENR:	TEKENINGNR:	MODEL: 9504N	HOUTSOORT:
--------	------------	---------------	-------------	-----------------	------------

	KLANT/PROJECT: overzicht modellen 9504N met briefstuf			DCM NUMMER:
--	--	--	--	-------------

AANVRAAG:	SCHAAL:	GETEKEND: MN	LEVERWEEK:	1.2a P.52
-----------	---------	-----------------	------------	-----------

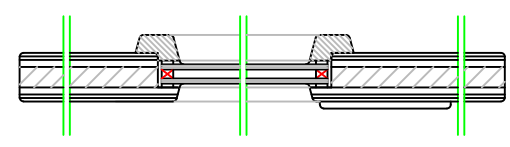
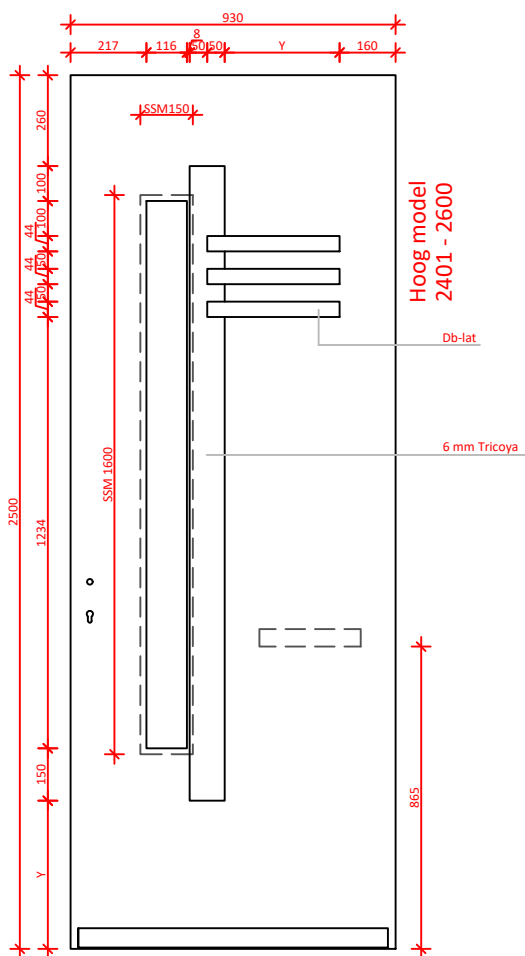
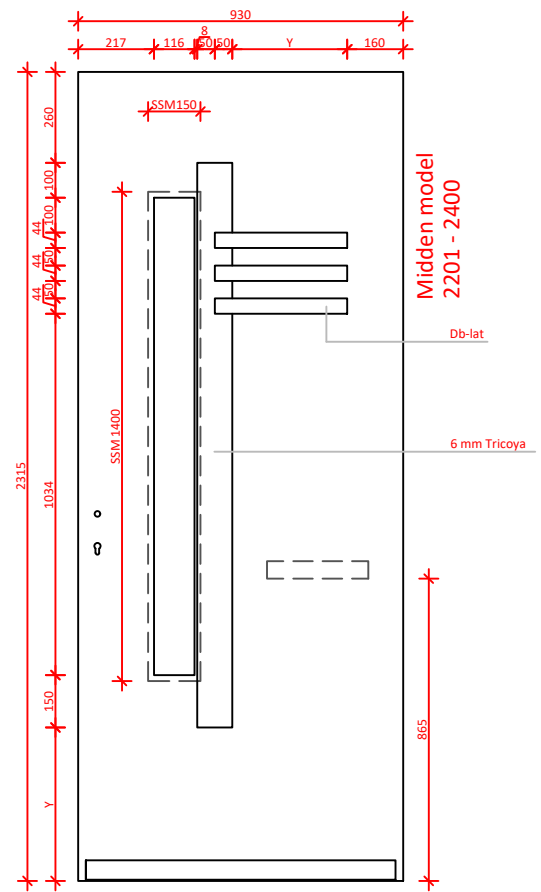
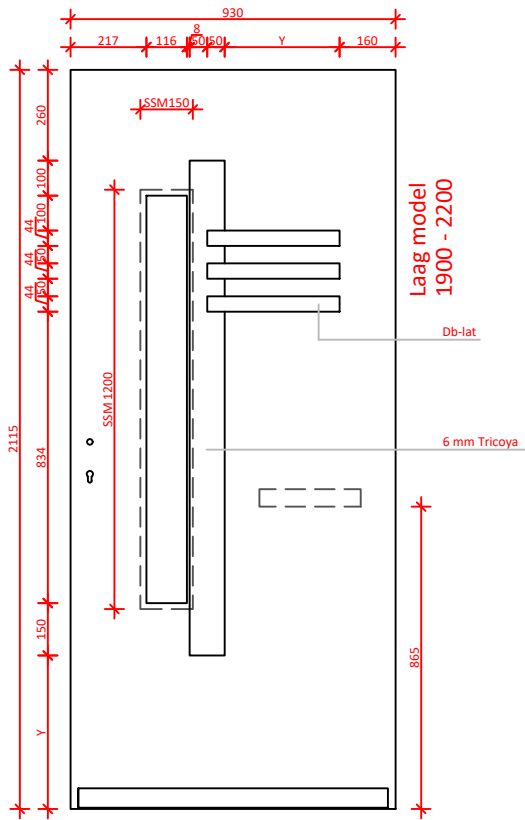

DATUM:	GEWIJZIGD:	CALCULATIENR:	TEKENINGNR:	MODEL: 9505N	HOUTSOORT:
--------	------------	---------------	-------------	-----------------	------------

	KLANT/PROJECT: overzicht modellen 9505N			DCM NUMMER:
--	--	--	--	-------------

AANVRAAG:	SCHAAL:	GETEKEND: MN	LEVERWEEK:	1.2a P.53
-----------	---------	-----------------	------------	-----------

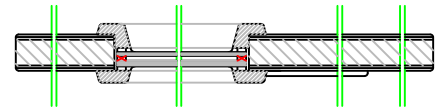
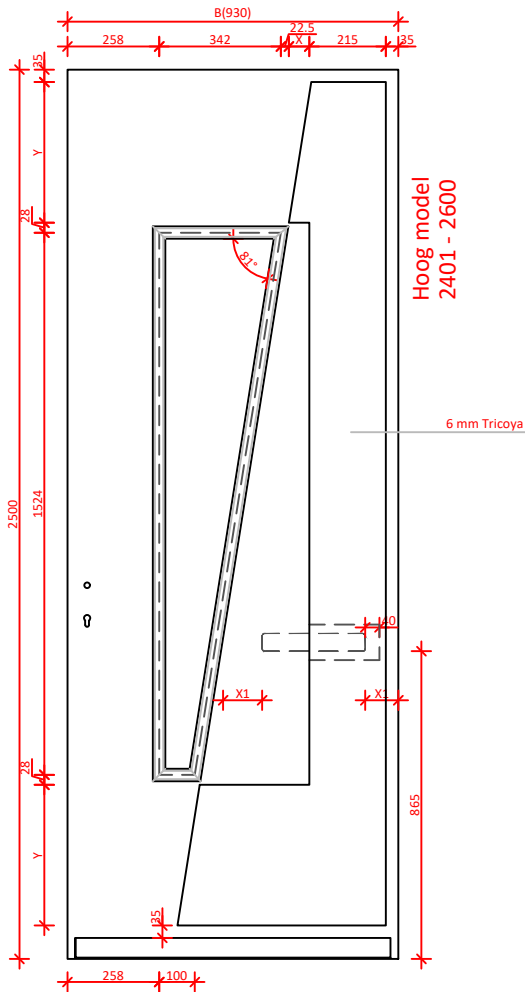
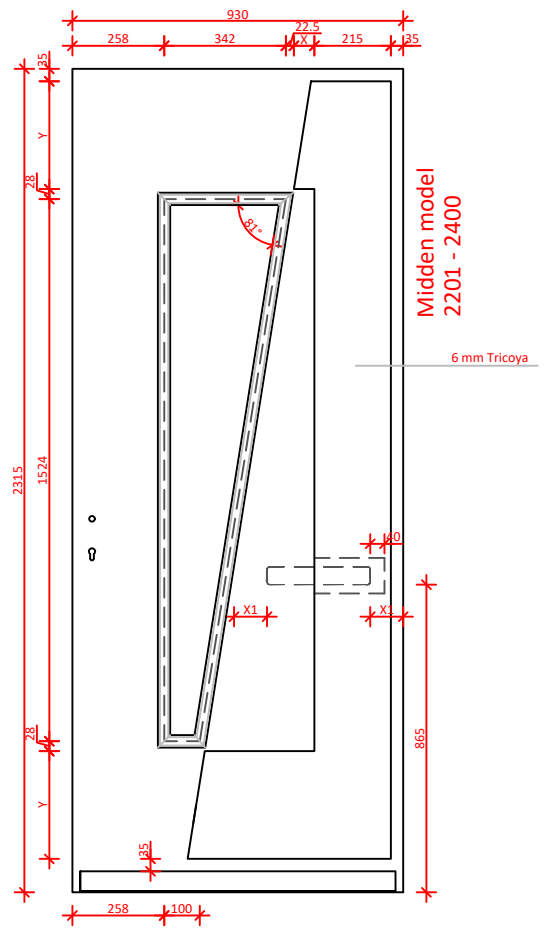
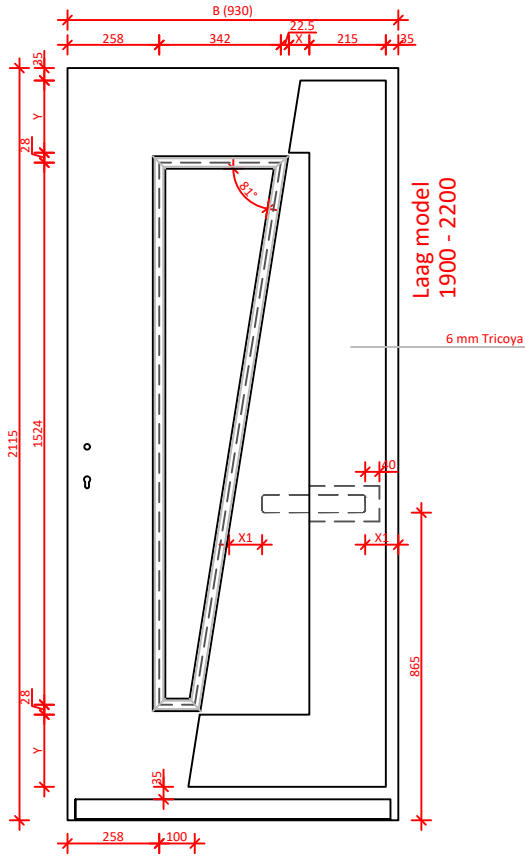

DATUM:	GEWIJZIGD: 21-04-2020	CALCULATIENR:	TEKENINGNR: 9536N	MODEL: 9536N	HOUTSOORT:
KLANT/PROJECT: overzicht modellen 9536N L1 - R4					DCM NUMMER:
		AANVRAAG:	SCHAAL:	GETEKEND: MN	LEVERWEEK: 1.2a P.54

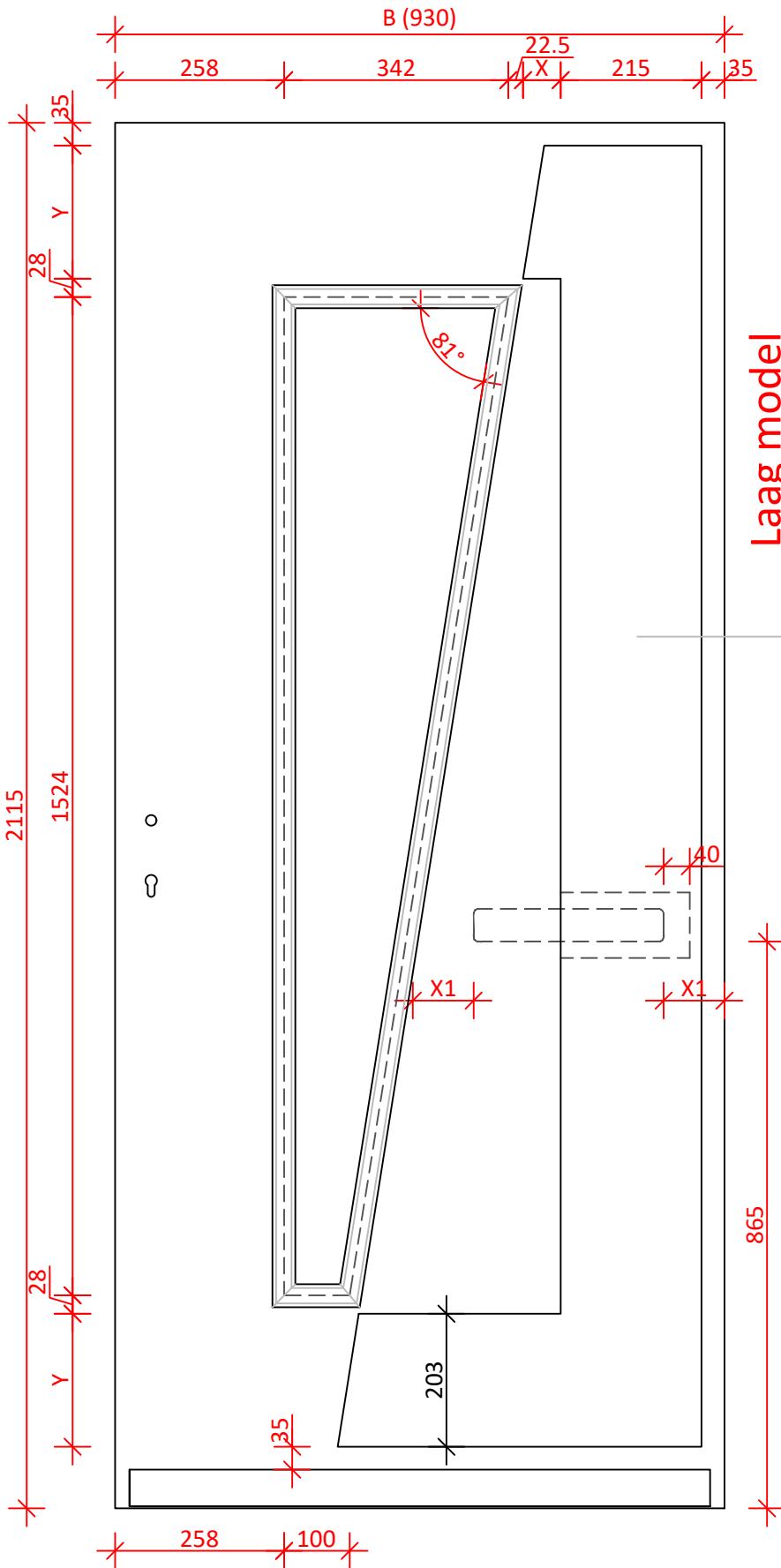

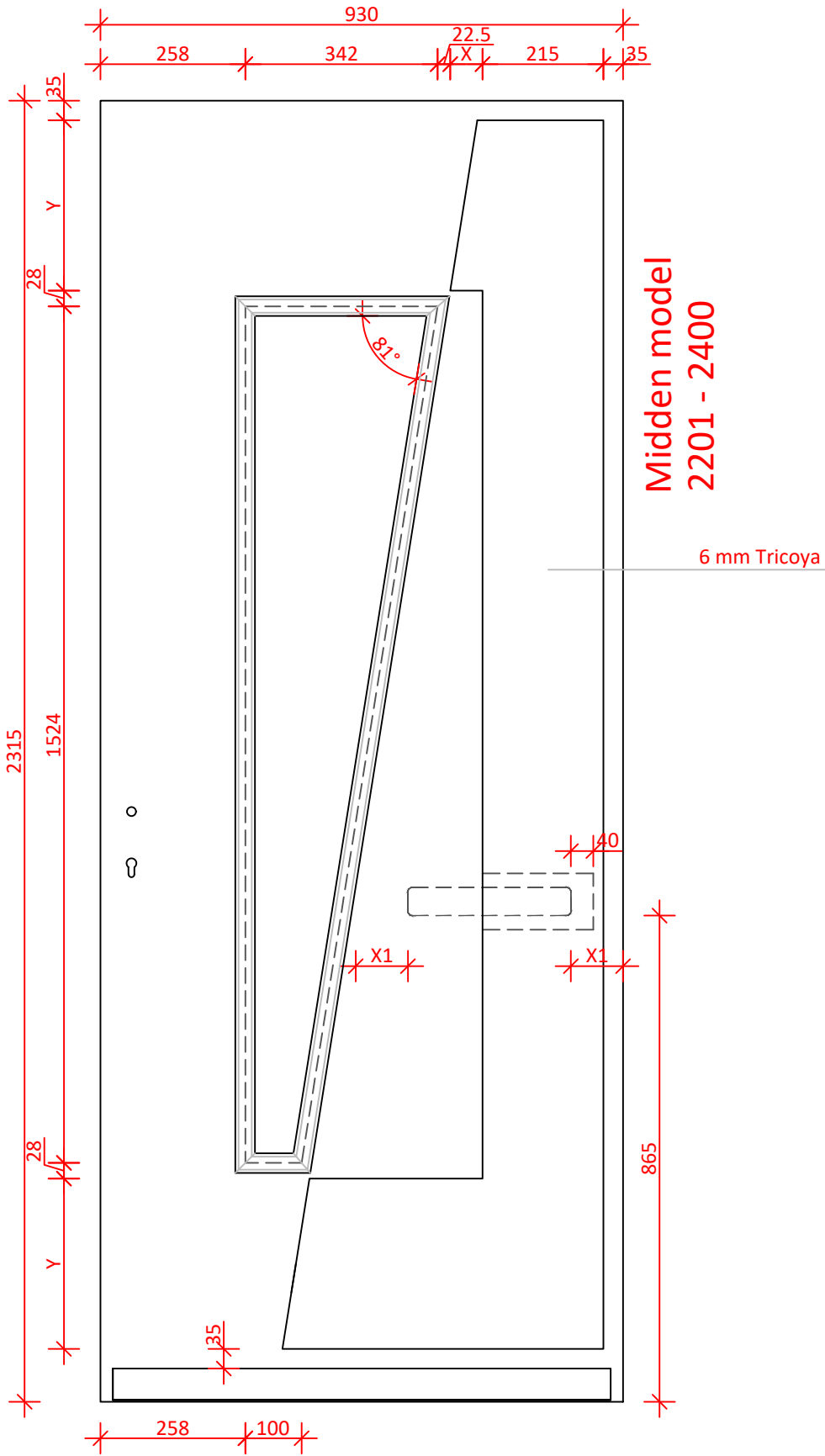

DATUM:	GEWIJZIGD: 21-04-2020	CALCULATIENR:	TEKENINGNR: 9536N	MODEL: 9536N	HOUTSOORT:
			KLANT/PROJECT: 9536N Laag model L1 -R4		DCM NUMMER:
			AANVRAAG:	SCHAAL:	GETEKEND: MN

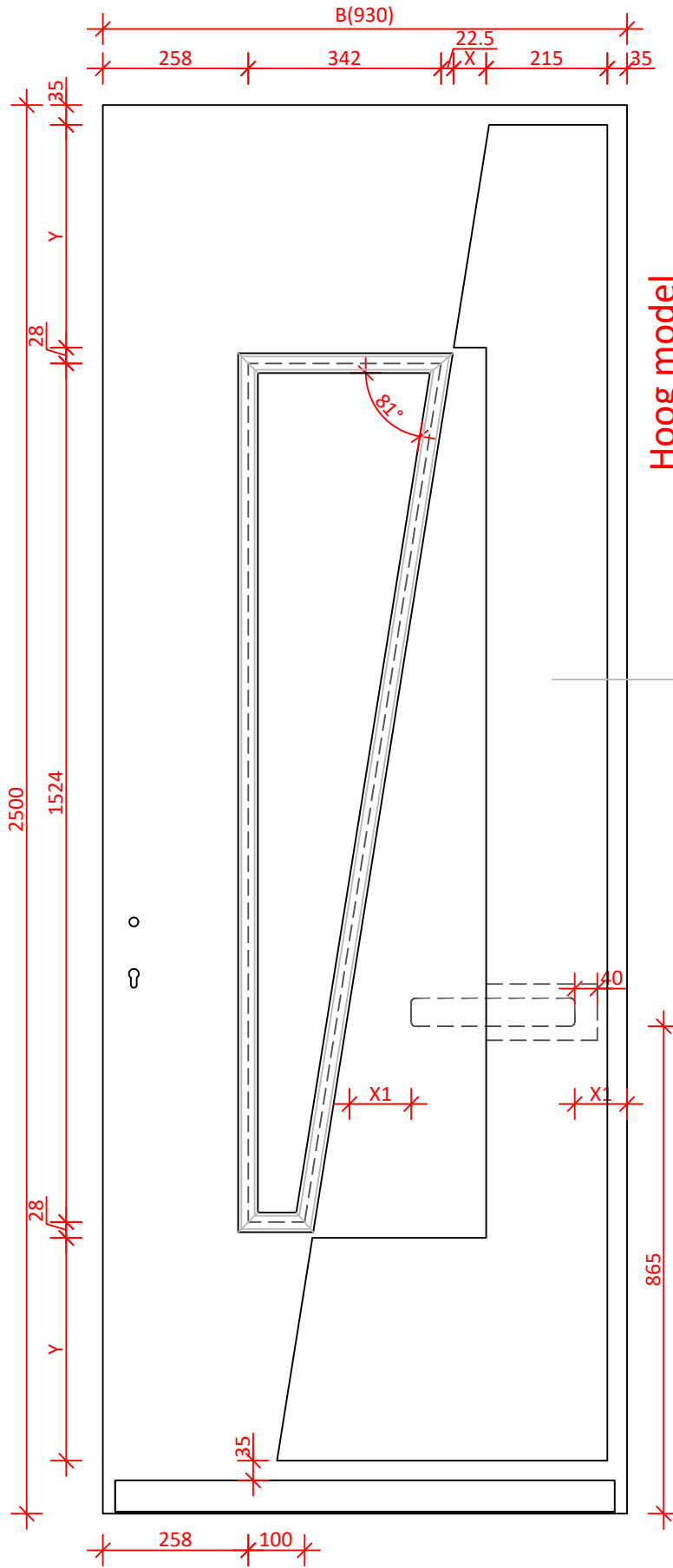

Midden model
2201 - 2400

DATUM:	GEWIJZIGD: 21-04-2020	CALCULATIENR:	TEKENINGNR: 9536N	MODEL: 9536N	HOUTSOORT:
			KLANT/PROJECT: 9536N Midden model L1 - R4		DCM NUMMER:
			AANVRAAG:	SCHAAL:	GETEKEND: MN



DATUM:	GEWIJZIGD: 21-04-2020	CALCULATIENR:	TEKENINGNR: 9536N	MODEL: 9536N	HOUTSOORT:
			KLANT/PROJECT: 9536N Hoog model L1 - R4		DCM NUMMER:
AANVRAAG:		SCHAAL:	GETEKEND: MN	LEVERWEEK:	

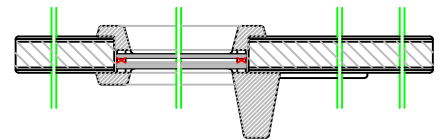
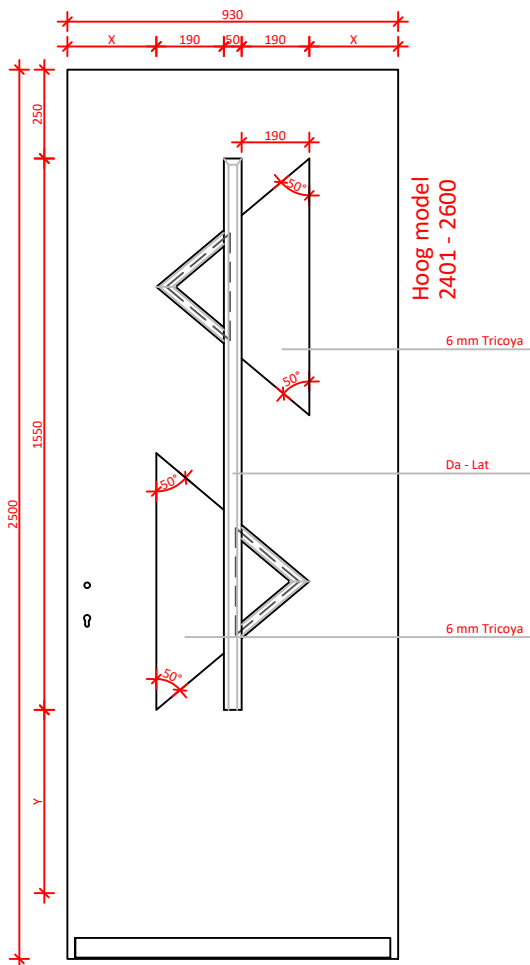
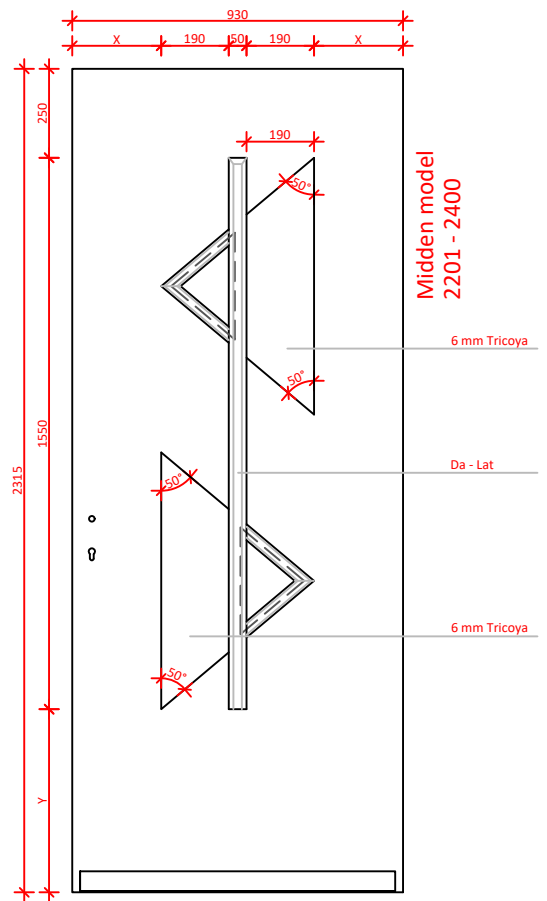
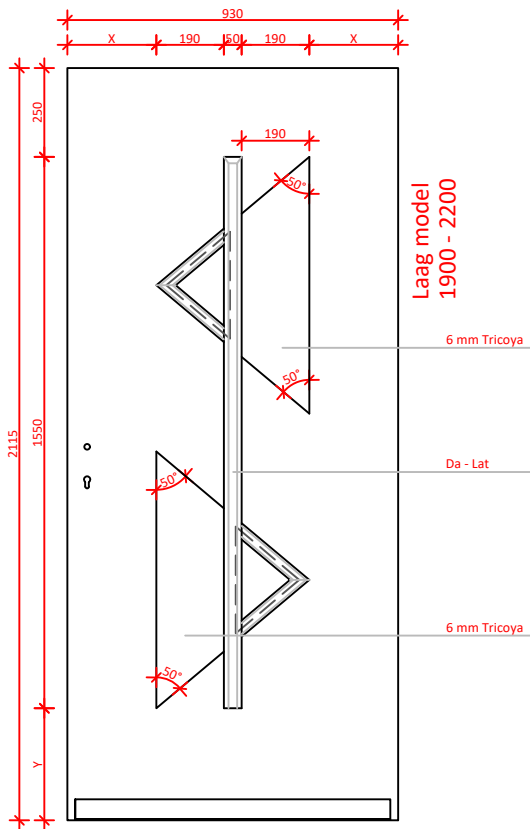

DATUM:	GEWIJZIGD:	CALCULATIENR:	TEKENINGNR:	MODEL: 9538	HOUTSOORT:
--------	------------	---------------	-------------	----------------	------------

	KLANT/PROJECT: overzicht modellen 9538 L1 - R4			DCM NUMMER:
--	---	--	--	-------------

AANVRAAG:	SCHAAL:	GETEKEND: MN	LEVERWEEK: 1.2a P.58
-----------	---------	-----------------	-------------------------

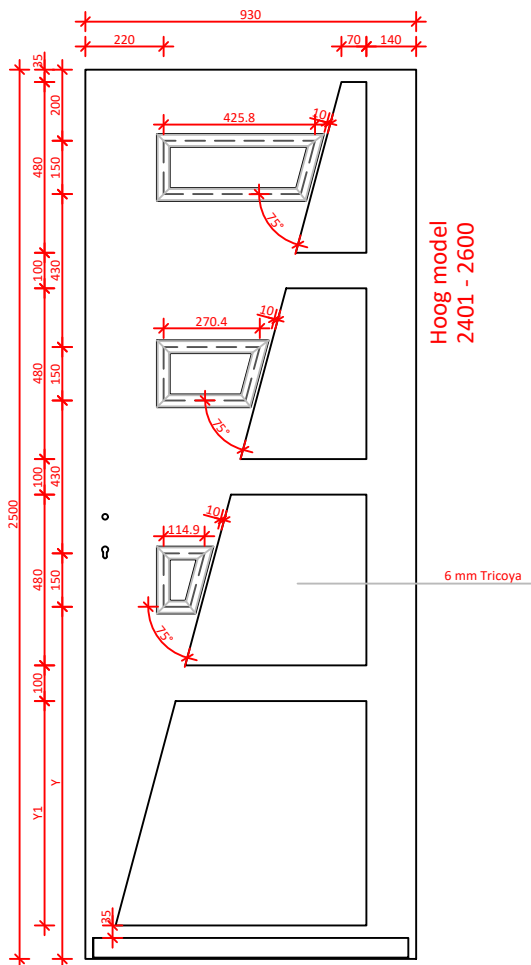
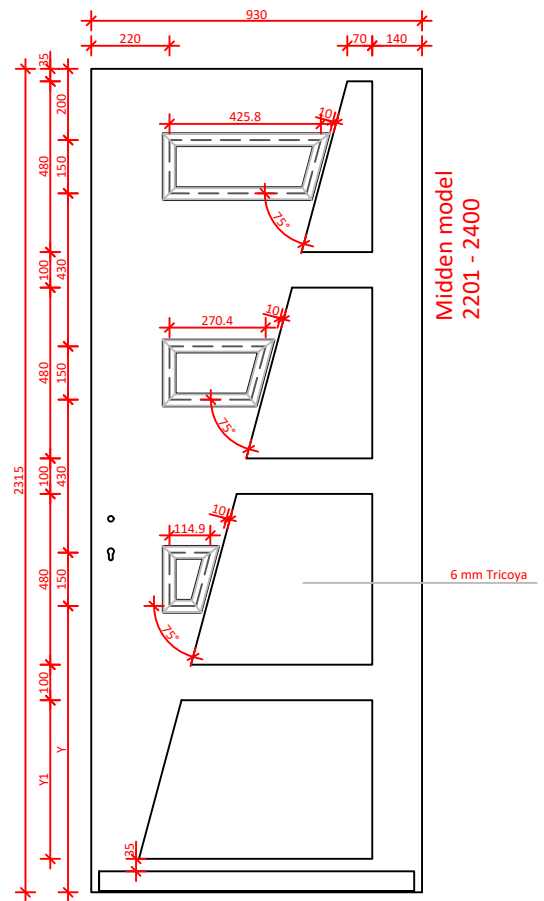
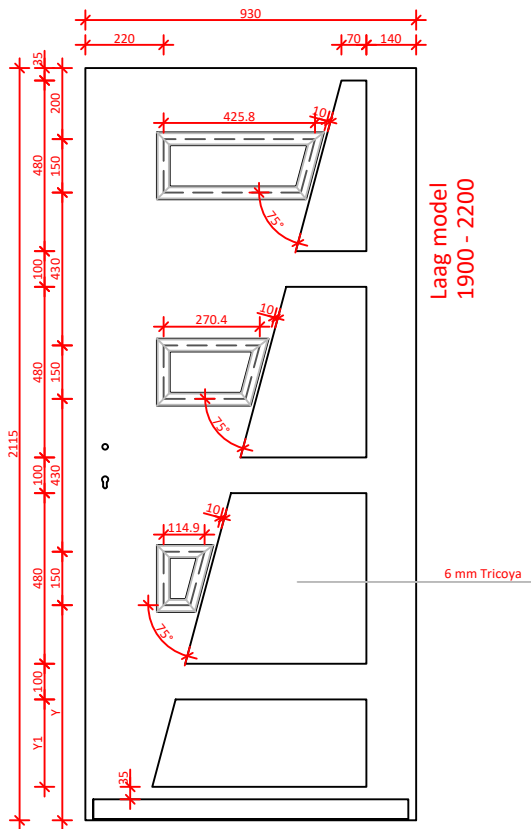

DATUM:	GEWIJZIGD:	CALCULATIENR:	TEKENINGNR:	MODEL: 9548N	HOUTSOORT:
--------	------------	---------------	-------------	-----------------	------------

	KLANT/PROJECT: overzicht modellen 9548N L1 - R4			DCM NUMMER:
--	--	--	--	-------------

AANVRAAG:	SCHAAL:	GETEKEND: MN	LEVERWEEK: 1.2a P.59
-----------	---------	-----------------	-------------------------

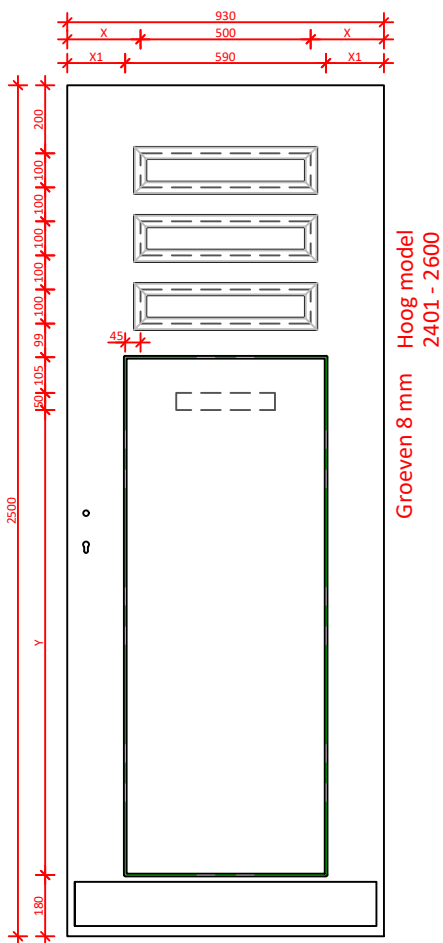
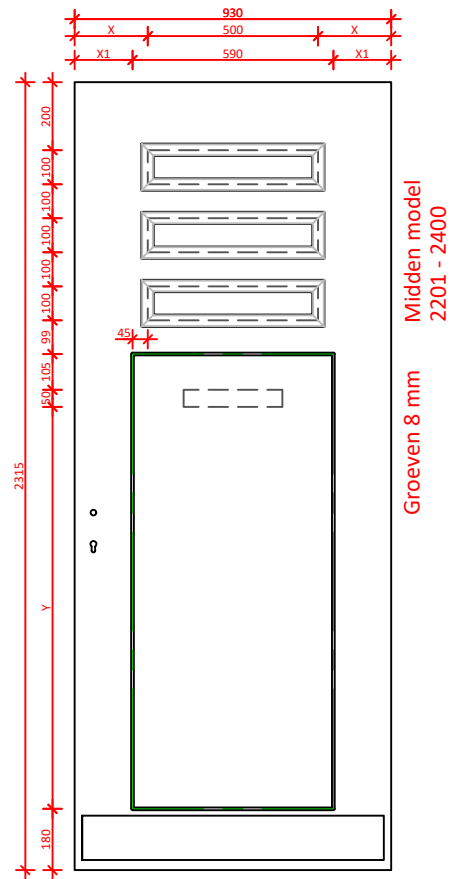
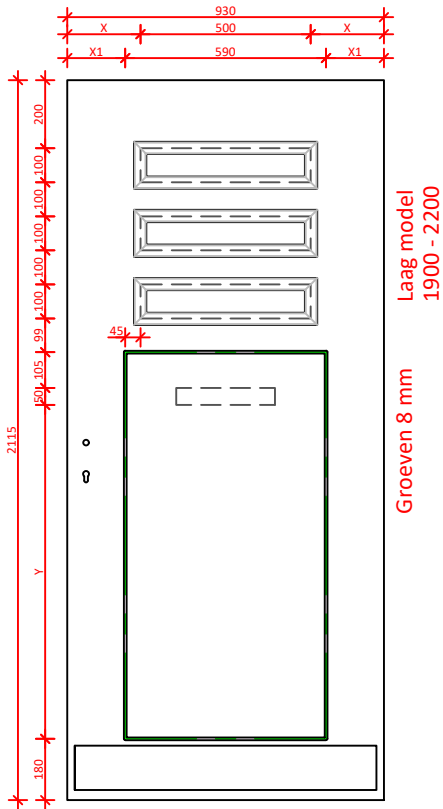

DATUM:	GEWIJZIGD:	CALCULATIENR:	TEKENINGNR: 9578N	MODEL: 9578N	HOUTSOORT:
--------	------------	---------------	----------------------	-----------------	------------

	KLANT/PROJECT: overzicht modellen 9578N			DCM NUMMER:
--	--	--	--	-------------

AANVRAAG:	SCHAAL:	GETEKEND: MN	LEVERWEEK:	1.2a P.60
-----------	---------	-----------------	------------	-----------

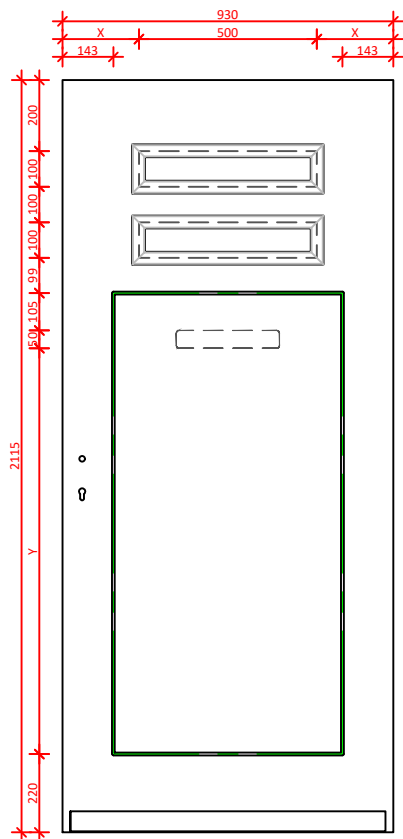

Laag model
1900 - 2200

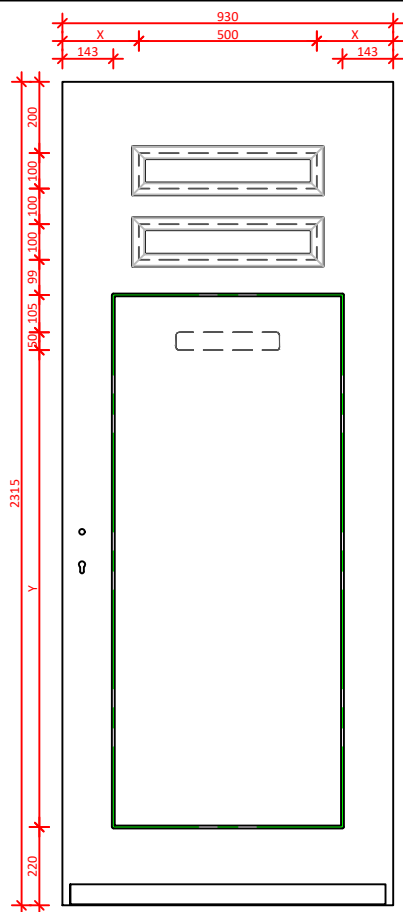

Midden model
2201 - 2400

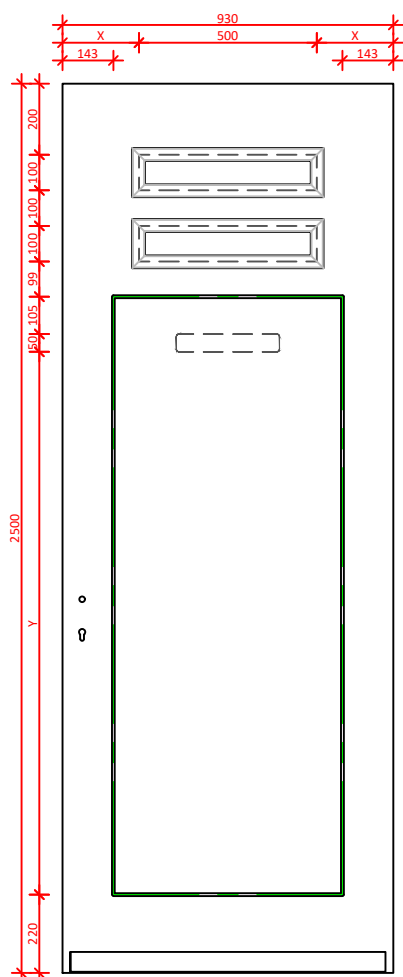

Hoog model
2401 - 2600

Strakke SponningMaat

- Pasmaat deurbreedte t/m 1000 mm : SSM 500mm
- Pasmaat deurbreedte 1001 t/m 1100 mm : SSM 600mm
- Pasmaat deurbreedte > 1101 mm : SSM 700mm

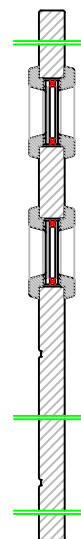

DATUM:	GEWIJZIGD:	CALCULATIENR:	TEKENINGNR: 9579N	MODEL: 9579N	HOUTSOORT:
--------	------------	---------------	----------------------	-----------------	------------

KEGRO DEUREN	KLANT/PROJECT: overzicht modellen 9579N			DCM NUMMER:
-----------------------	--	--	--	-------------

AANVRAAG:	SCHAAL:	GETEKEND: MN	LEVERWEEK:	1.2a P.61
-----------	---------	-----------------	------------	-----------

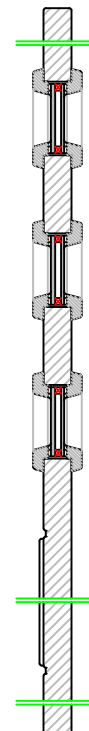
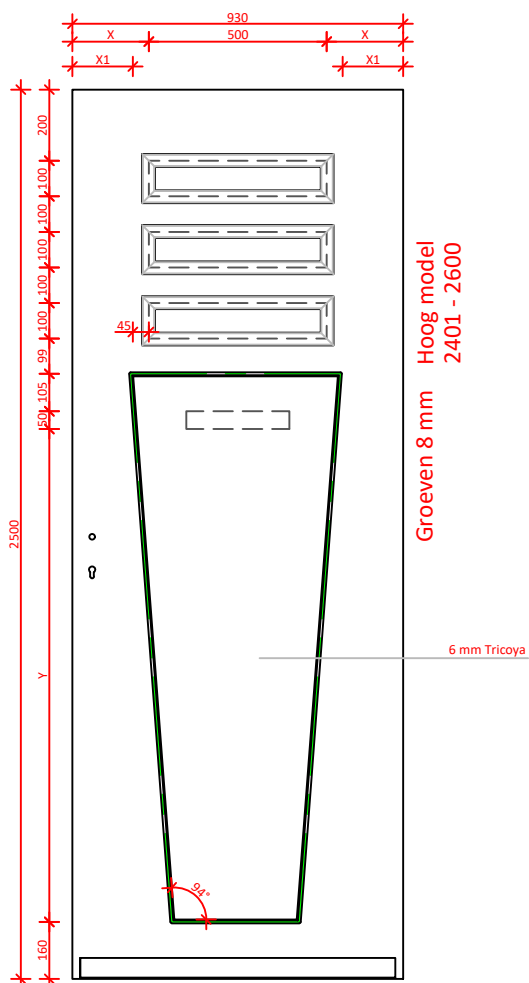
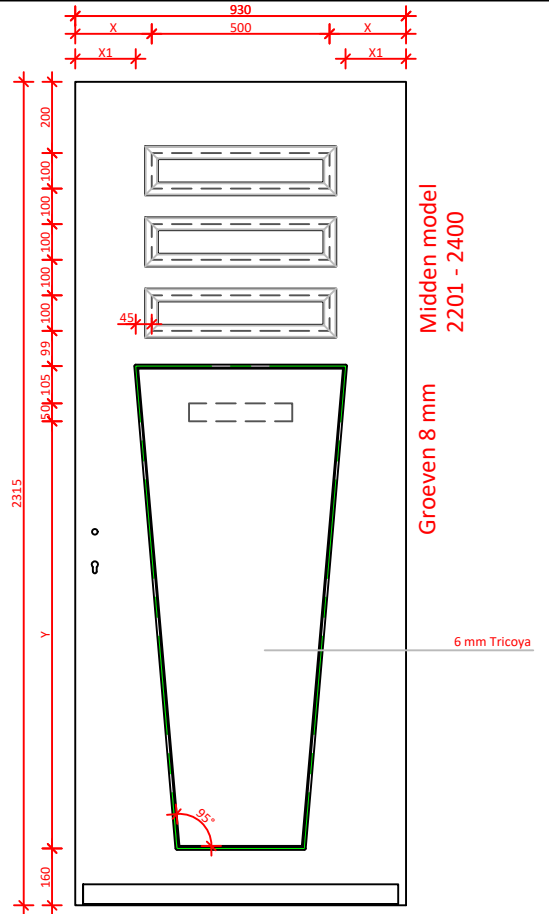
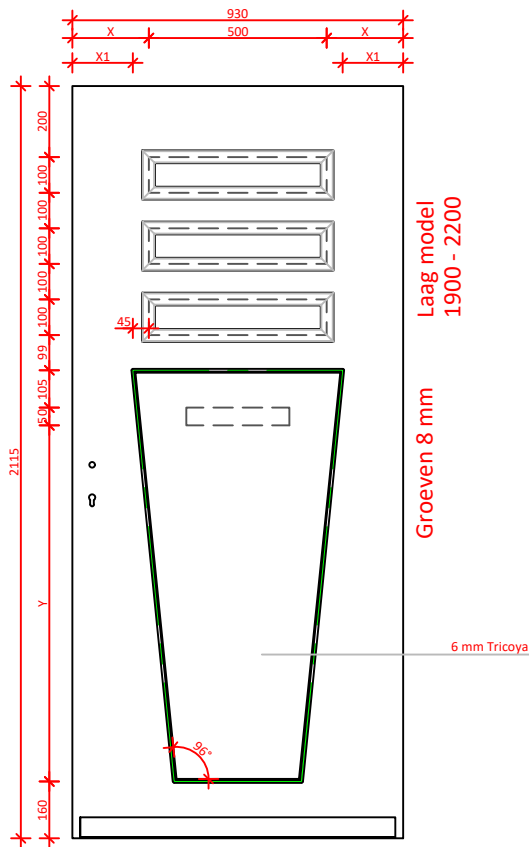

Strakke SponningMaat

- Pasmaat deurbreedte t/m 1000 mm : SSM 500mm
- Pasmaat deurbreedte 1001 t/m 1100 mm : SSM 600mm
- Pasmaat deurbreedte > 1101 mm : SSM 700mm

DATUM:	GEWIJZIGD:	CALCULATIENR:	TEKENINGNR:	MODEL: 9580N	HOUTSOORT:
--------	------------	---------------	-------------	-----------------	------------

KEGRO DEUREN	KLANT/PROJECT: overzicht modellen 9580N			DCM NUMMER:
-----------------------	--	--	--	-------------

AANVRAAG:	SCHAAL:	GETEKEND: MN	LEVERWEEK:	1.2a P.62
-----------	---------	-----------------	------------	-----------

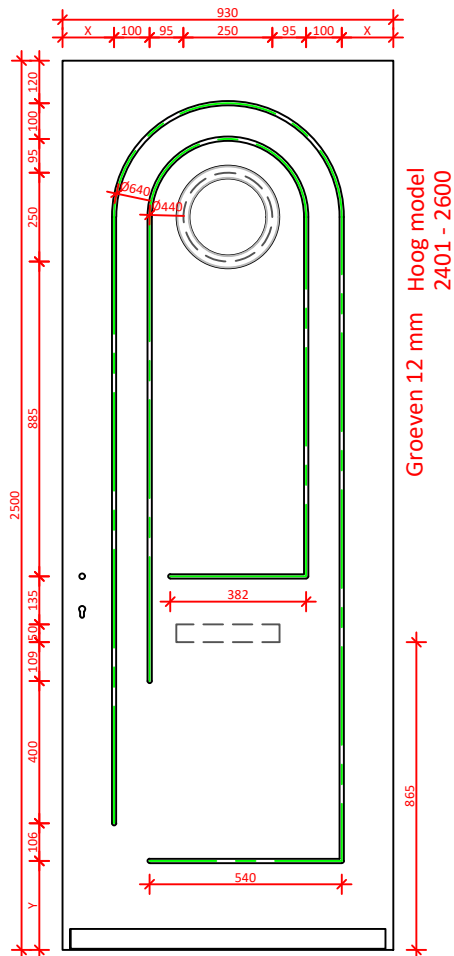
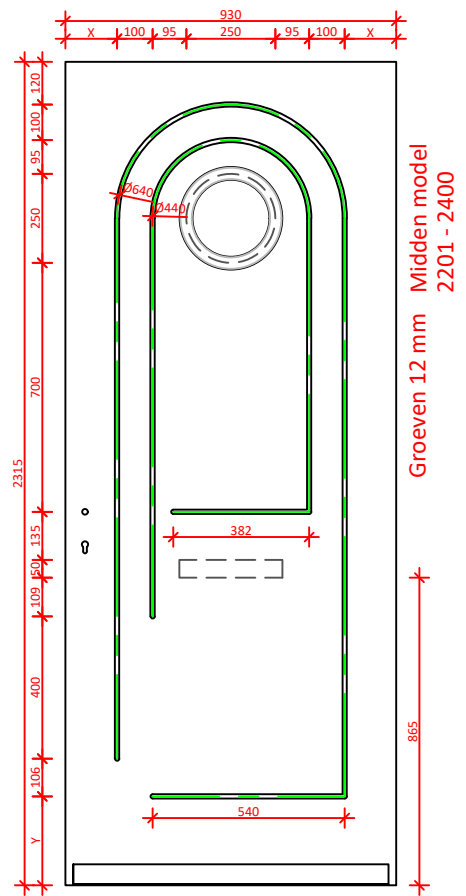
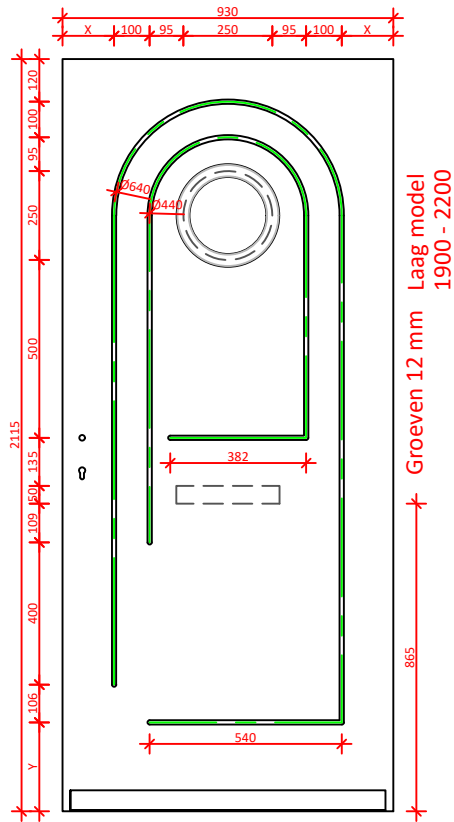

DATUM:	GEWIJZIGD:	CALCULATIENR:	TEKENINGNR:	MODEL: 9726	HOUTSOORT:
--------	------------	---------------	-------------	----------------	------------

	KLANT/PROJECT: overzicht modellen 9726 L1 - R4			DCM NUMMER:
--	---	--	--	-------------

AANVRAAG:	SCHAAL:	GETEKEND: MN	LEVERWEEK: 1.2a P.63
-----------	---------	-----------------	-------------------------

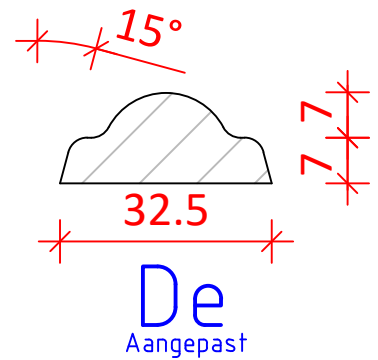
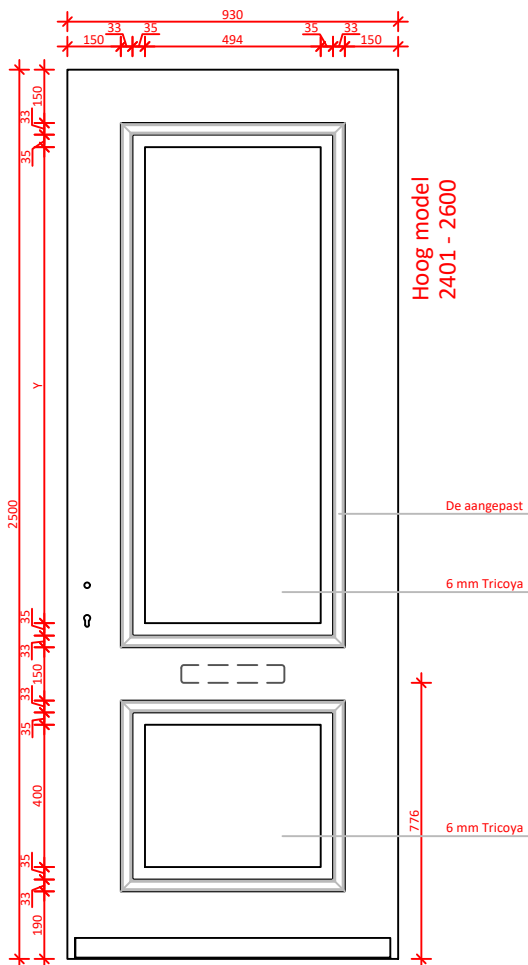
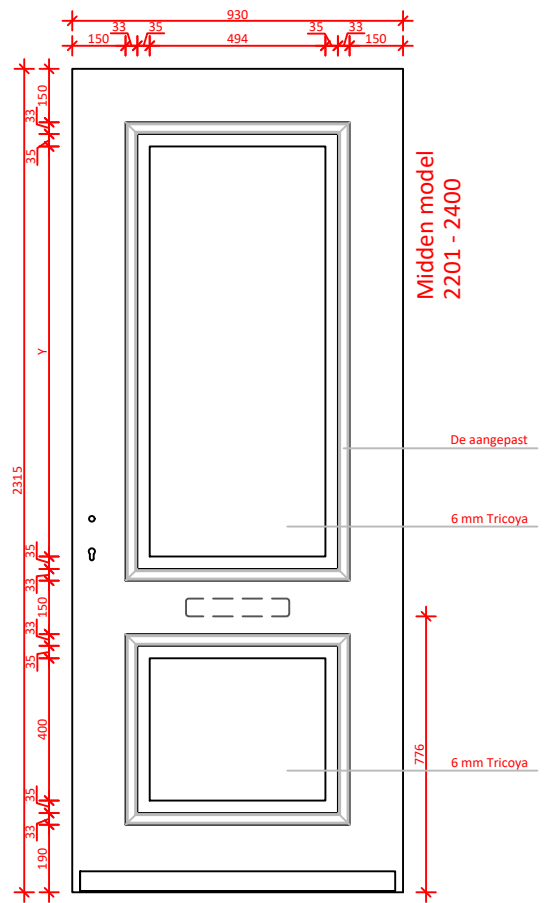
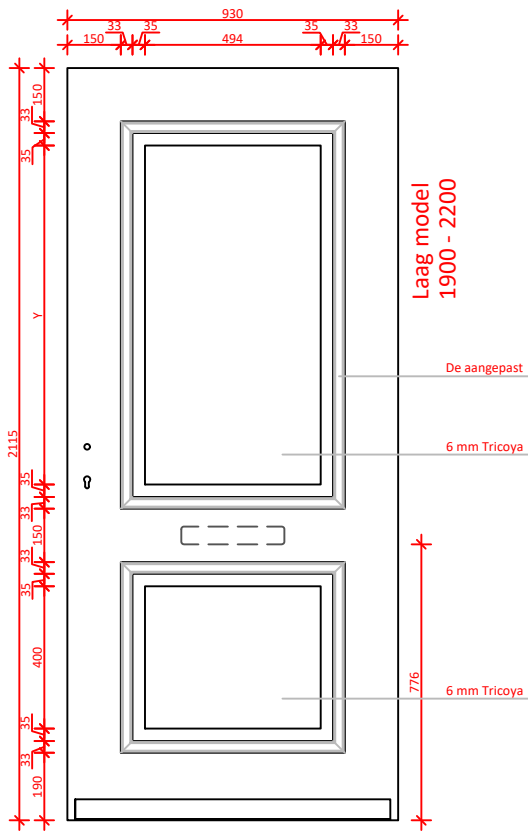

DATUM:	GEWIJZIGD:	CALCULATIENR:	TEKENINGNR:	MODEL: 9750	HOUTSOORT:
--------	------------	---------------	-------------	----------------	------------

	KLANT/PROJECT: overzicht modellen 9750			DCM NUMMER:
--	---	--	--	-------------

AANVRAAG:	SCHAAL:	GETEKEND: MN	LEVERWEEK: 1.2a P.64
-----------	---------	-----------------	-------------------------

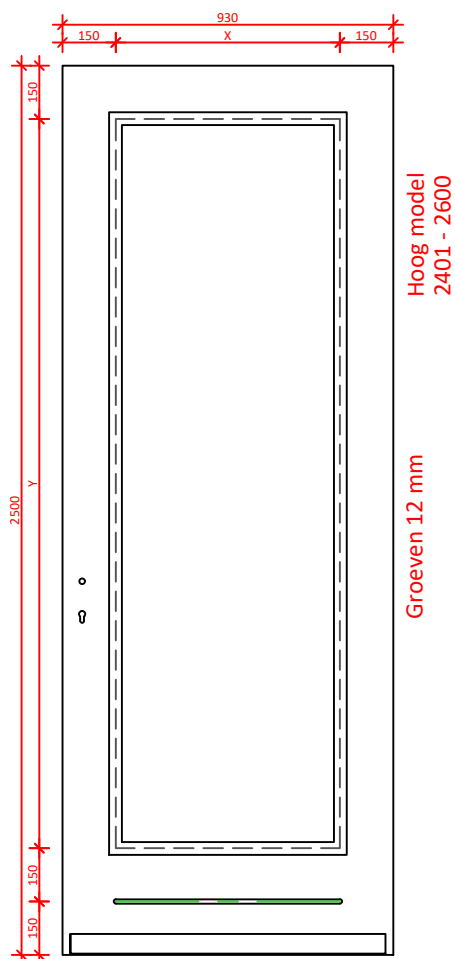
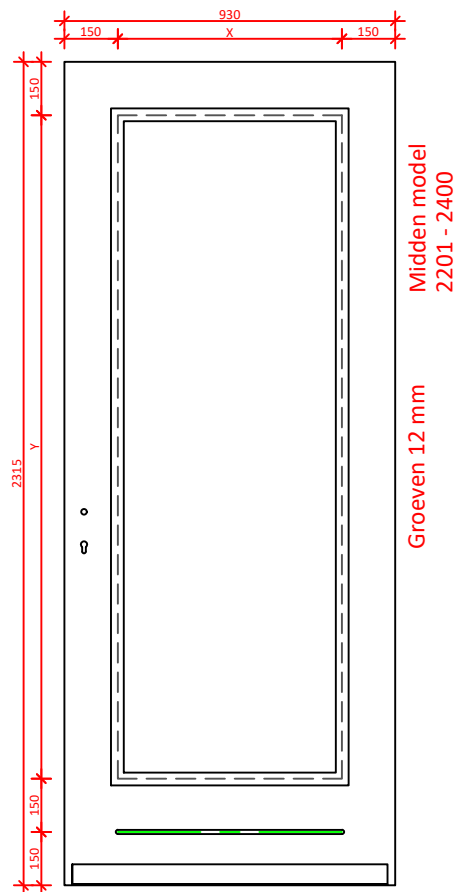
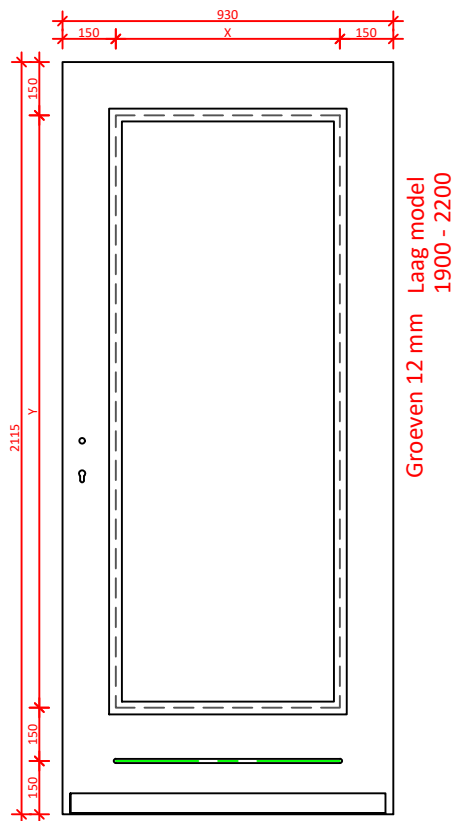

Alleen in KegaPro+ 74 mm.

DATUM:	GEWIJZIGD:	CALCULATIENR:	TEKENINGNR: 9768	MODEL: 9768	HOUTSOORT:
--------	------------	---------------	---------------------	----------------	------------

KEGRO DEUREN	KLANT/PROJECT: overzicht modellen 9768 L1 - R4			DCM NUMMER:
-----------------------	---	--	--	-------------

AANVRAAG:	SCHAAL:	GETEKEND:	LEVERWEEK:	1.2a P.65
-----------	---------	-----------	------------	-----------

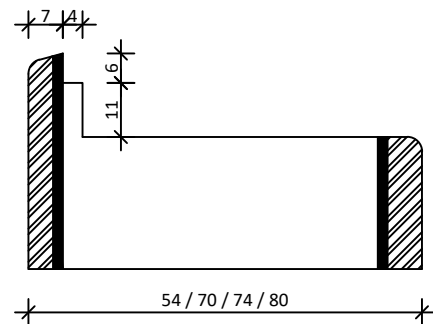
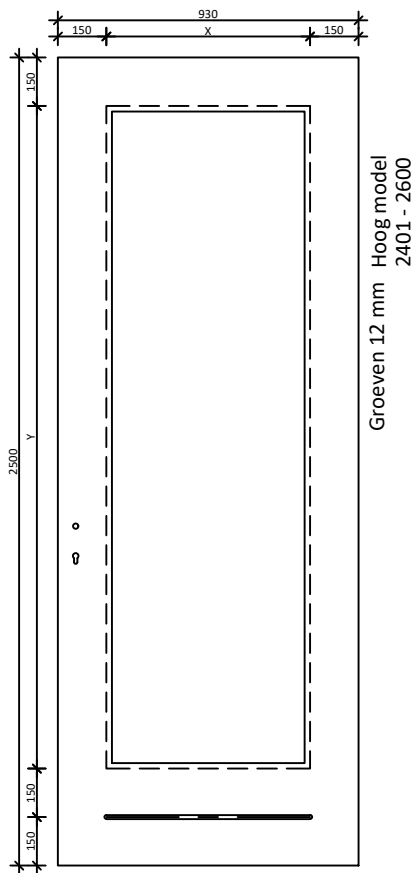
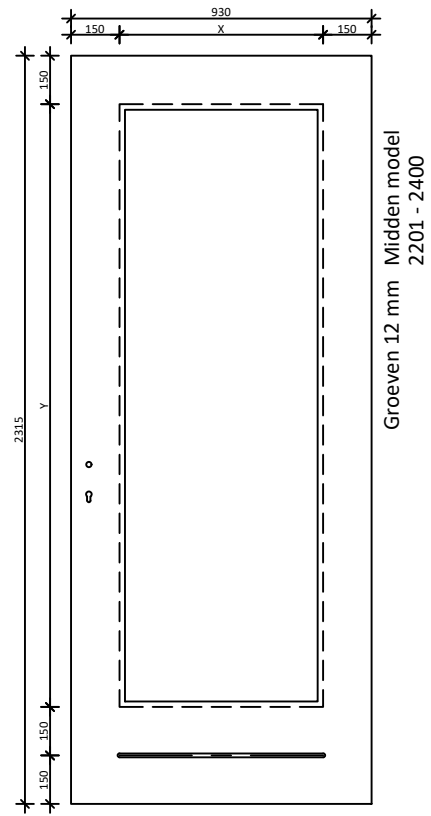
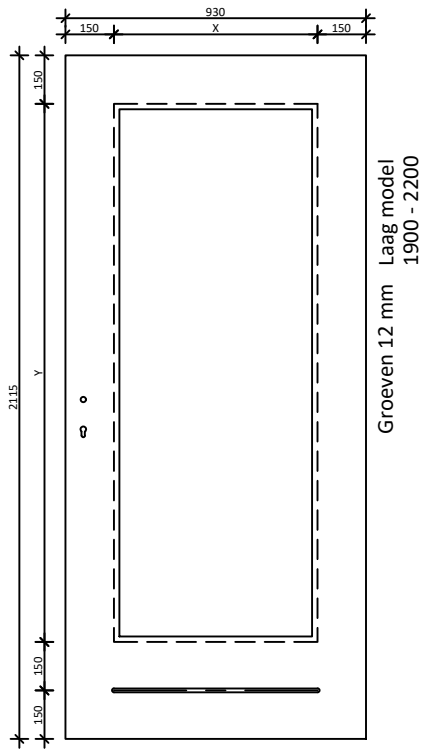

DATUM: 01-02-23	GEWIJZIGD:	CALCULATIENR:	TEKENINGNR: 9768DPN	MODEL: 9768DPN	HOUSOORT:
			KLANT/PROJECT: Modellen overzicht		DCM NUMMER:
			AANVRAAG:	SCHAAL:	GETEKEND: PN

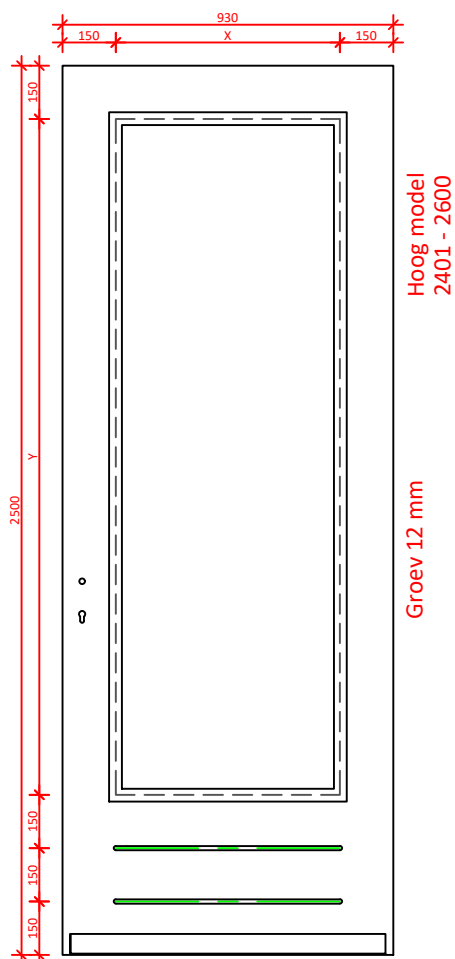
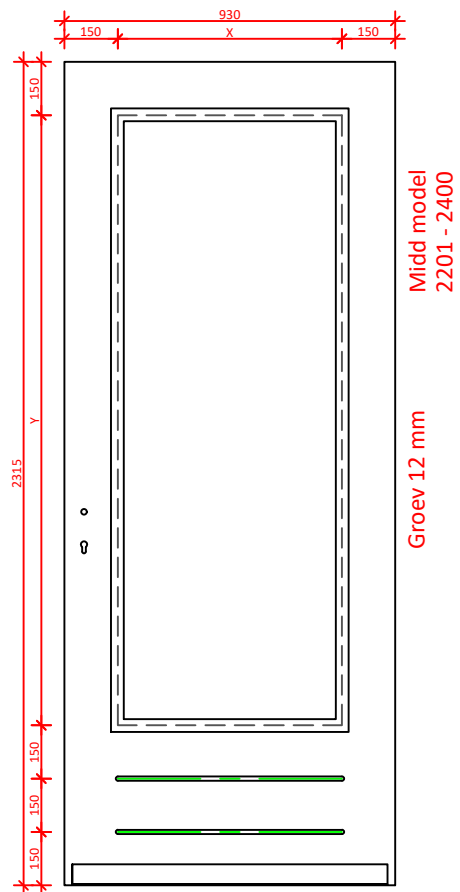
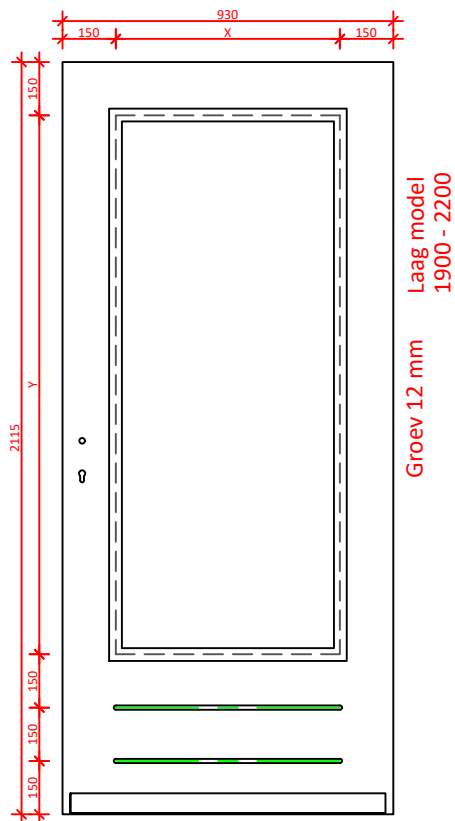

Alleen in KegaPro 74 mm .

DATUM:	GEWIJZIGD:	CALCULATIENR:	TEKENINGNR: 9769	MODEL: 9769	HOUTSOORT:
--------	------------	---------------	---------------------	----------------	------------

	KLANT/PROJECT: overzicht modell 9769 L1 - R4			DCM NUMMER:
--	---	--	--	-------------

AANVRAAG:	SCHAAL:	GETEKEND:	LEVERWEEK: 1.2a P.67
-----------	---------	-----------	-------------------------

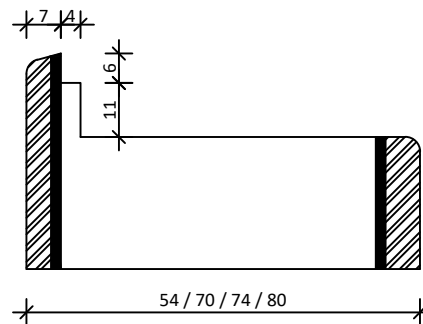
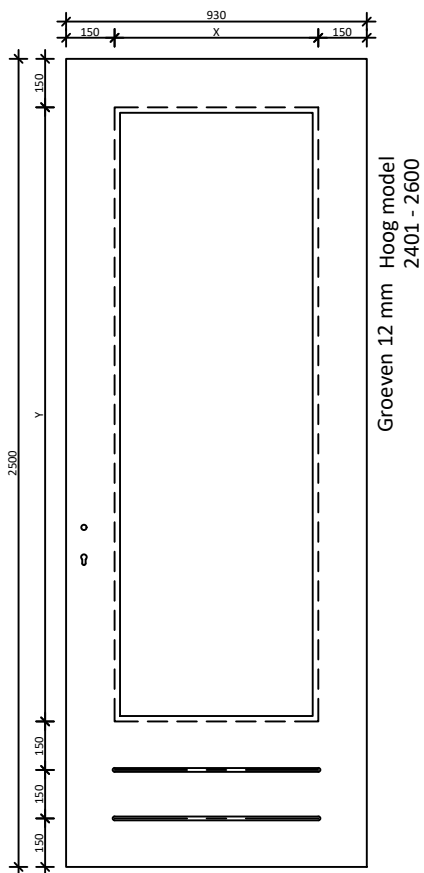
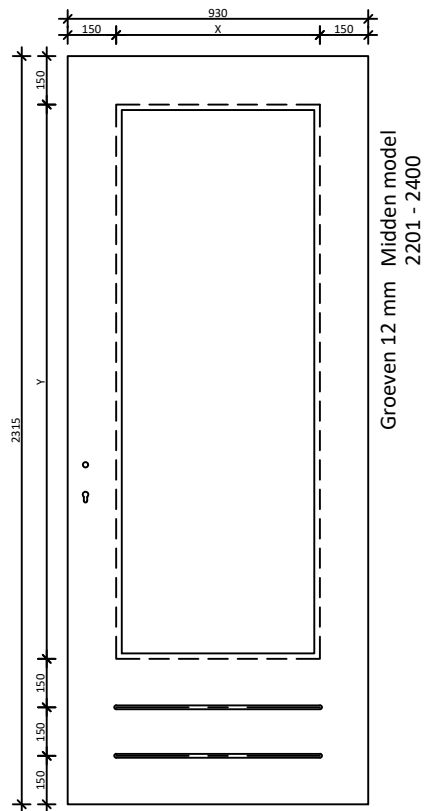
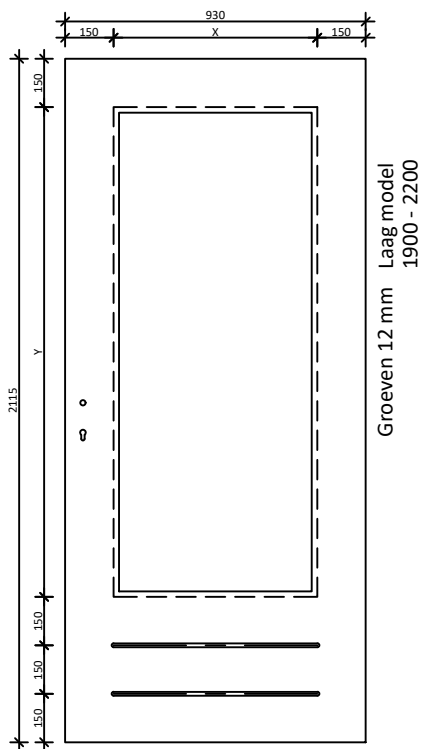

DATUM: 01-02-23	GEWIJZIGD:	CALCULATIENR:	TEKENINGNR: 9769DPN	MODEL: 9769DPN	HOUTSOORT:
					KLANT/PROJECT: Modellen overzicht
					DCM NUMMER:
AANVRAAG:	SCHAAL:	GETEKEND:	LEVERWEEK:	1.2a P.68	

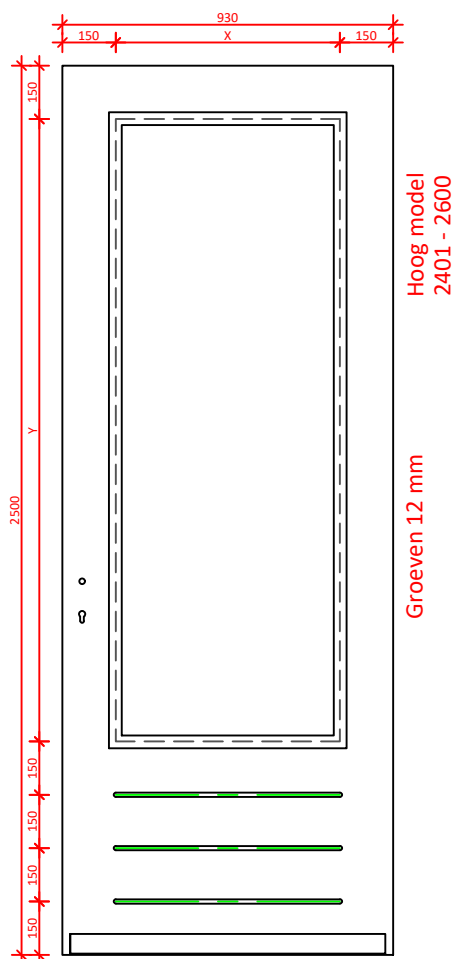
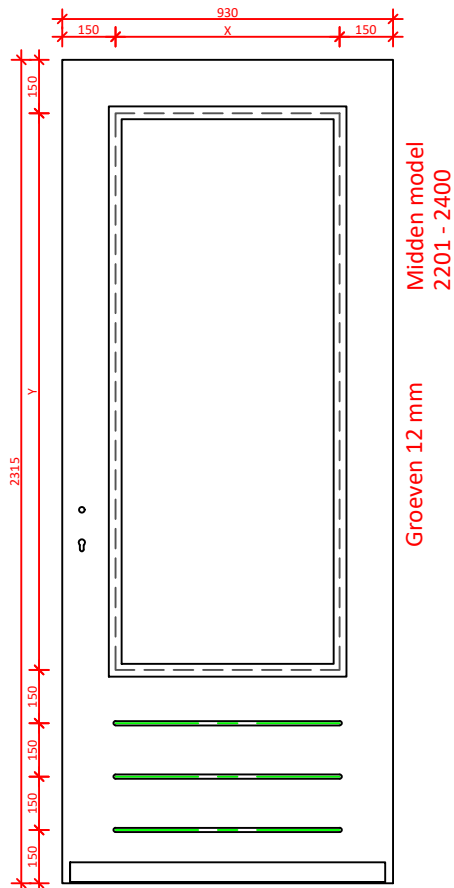
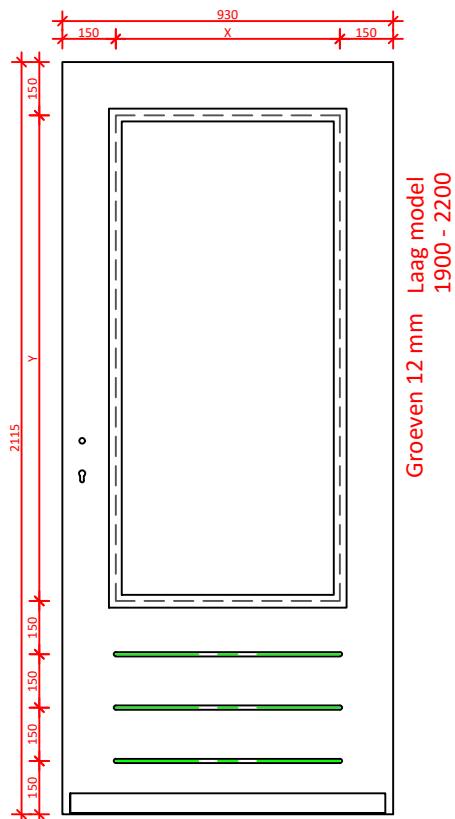

Alleen in KegaPro 74 mm.

DATUM:	GEWIJZIGD:	CALCULATIENR:	TEKENINGNR: 9770	MODEL: 9770	HOUTSOORT:
--------	------------	---------------	---------------------	----------------	------------

	KLANT/PROJECT: overzicht modellen 9770 L1 - R4			DCM NUMMER:
--	---	--	--	-------------

AANVRAAG:	SCHAAL:	GETEKEND:	LEVERWEEK:	1.2a P.69
-----------	---------	-----------	------------	-----------

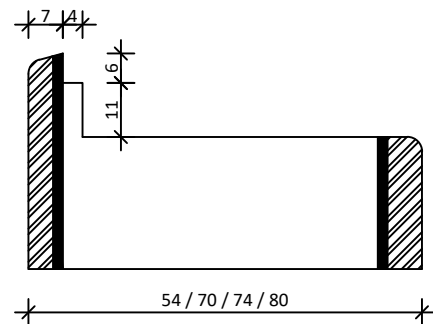
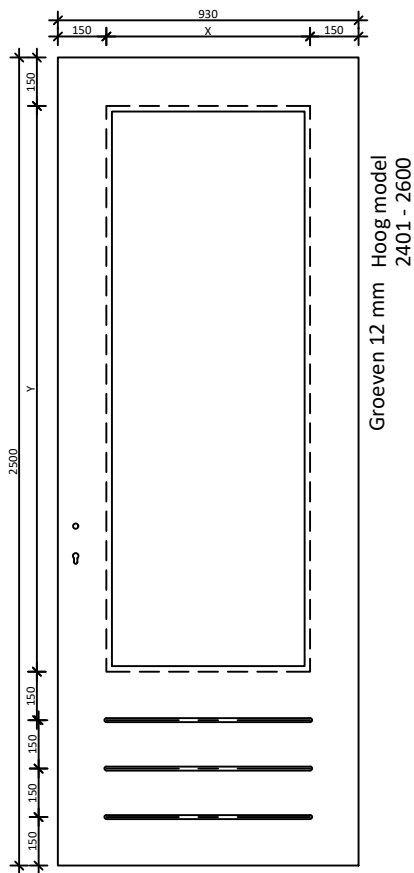
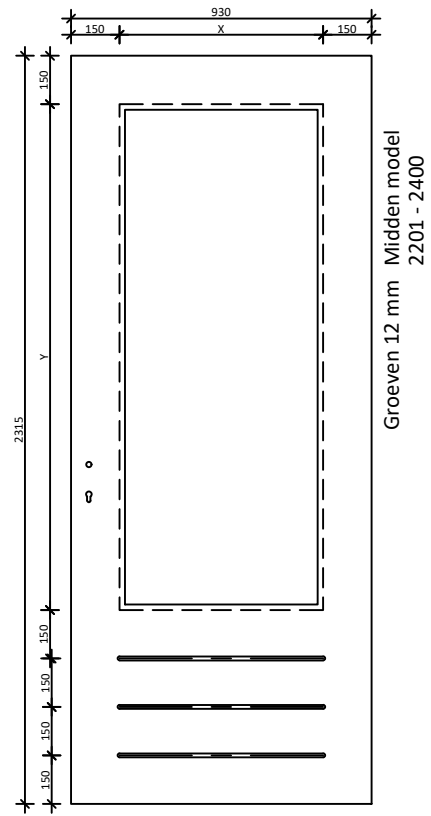
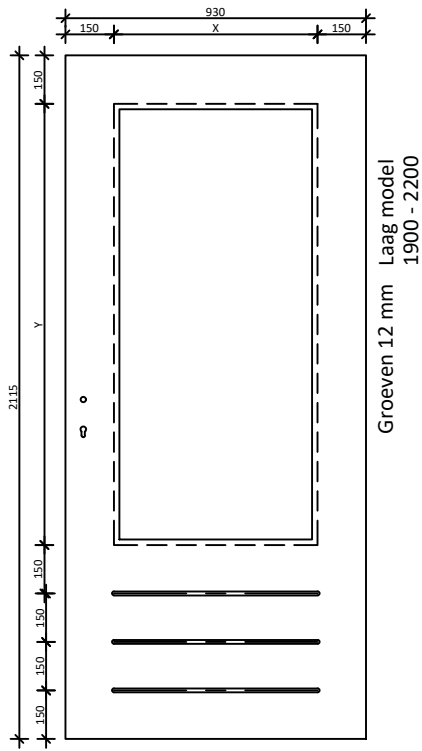

DATUM: 01-02-23	GEWIJZIGD:	CALCULATIENR:	TEKENINGNR: 9770DPN	MODEL: 9770DPN	HOUTSOORT:
			KLANT/PROJECT: Modellen overzicht		DCM NUMMER:
			AANVRAAG:	SCHAAL:	GETEKEND: PN

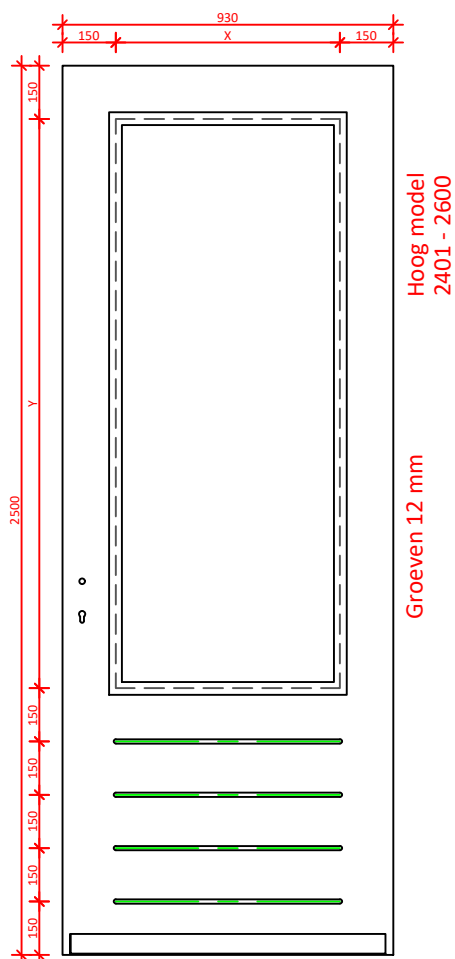
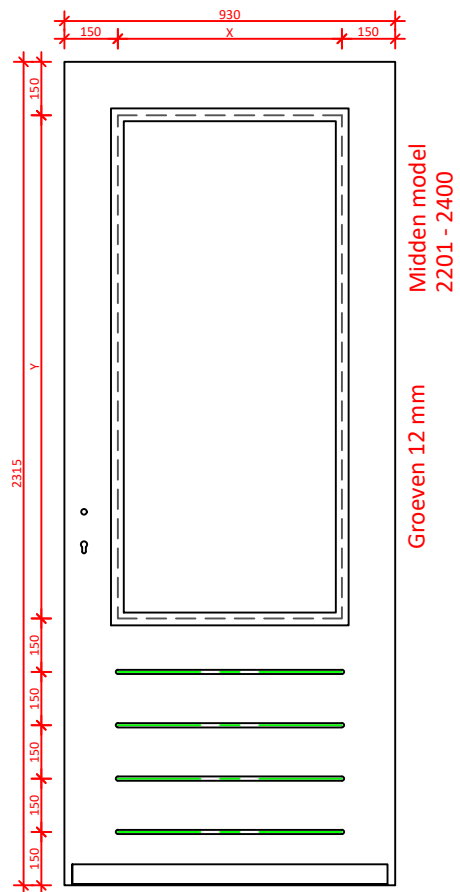
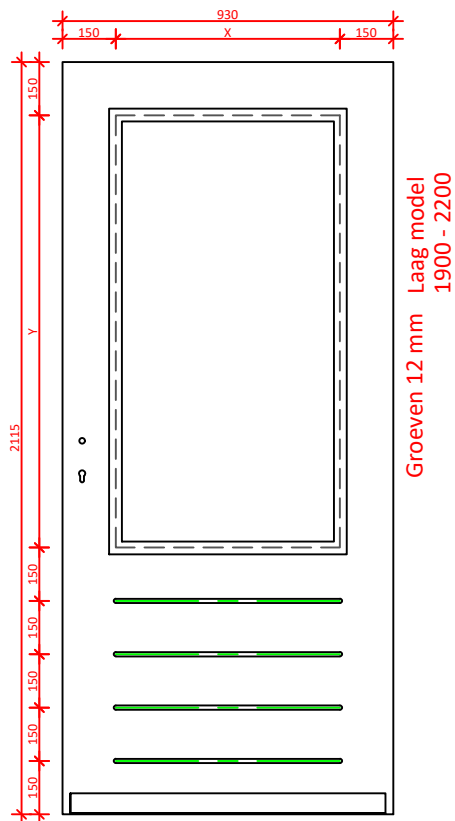

Alleen in KegaPro+ 74 mm.

DATUM:	GEWIJZIGD:	CALCULATIENR:	TEKENINGNR: 9771	MODEL: 9771	HOUTSOORT:
--------	------------	---------------	---------------------	----------------	------------

KEGRO DEUREN	KLANT/PROJECT: overzicht modellen 9771 L1 - R4			DCM NUMMER:
-----------------------	---	--	--	-------------

AANVRAAG:	SCHAAL:	GETEKEND:	LEVERWEEK: 1.2a P.71
-----------	---------	-----------	-------------------------

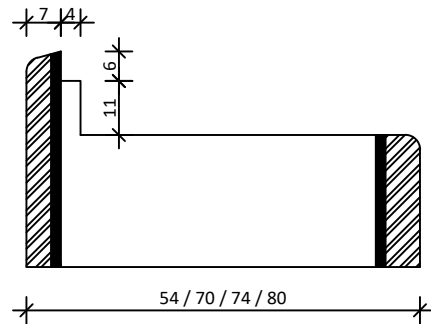
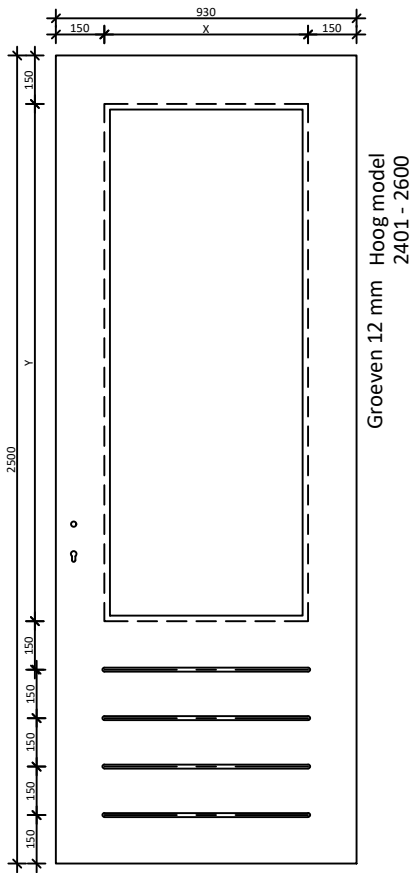
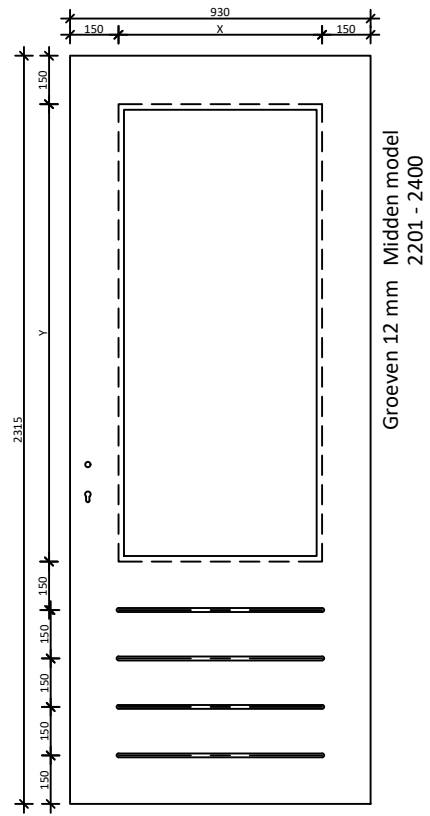
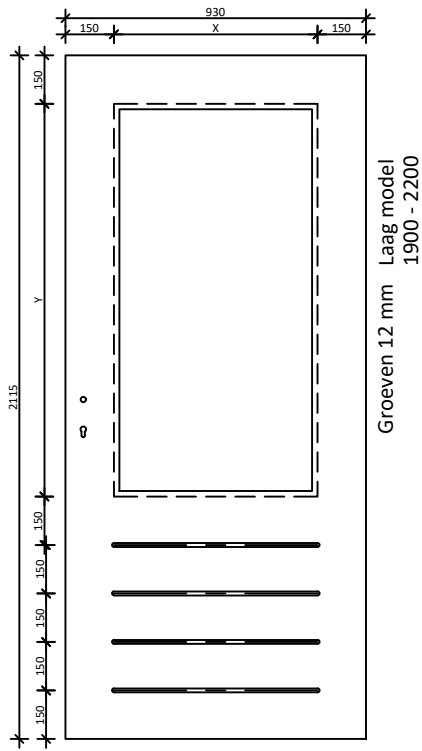

DATUM: 01-02-23	GEWIJZIGD:	CALCULATIENR:	TEKENINGNR: 9771DPN	MODEL: 9771DPN	HOUTSOORT:
			KLANT/PROJECT: Modellen overzicht		DCM NUMMER:
			AANVRAAG:	SCHAAL:	GETEKEND: PN

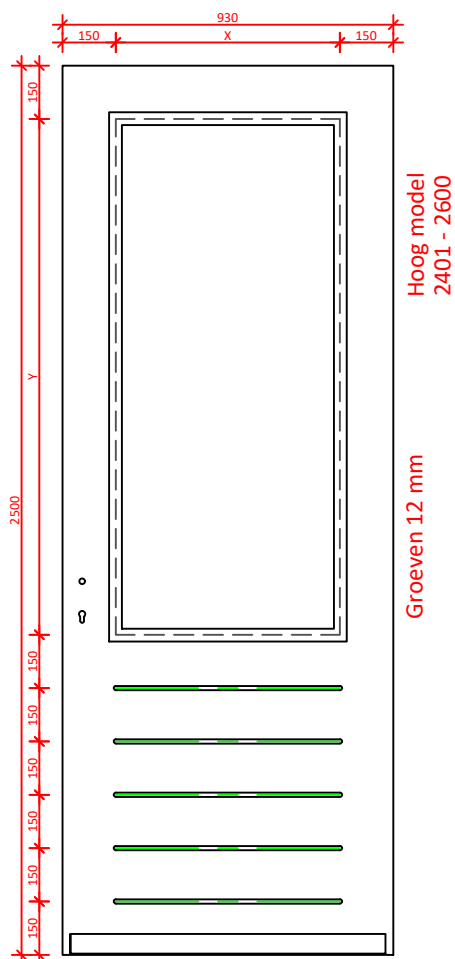
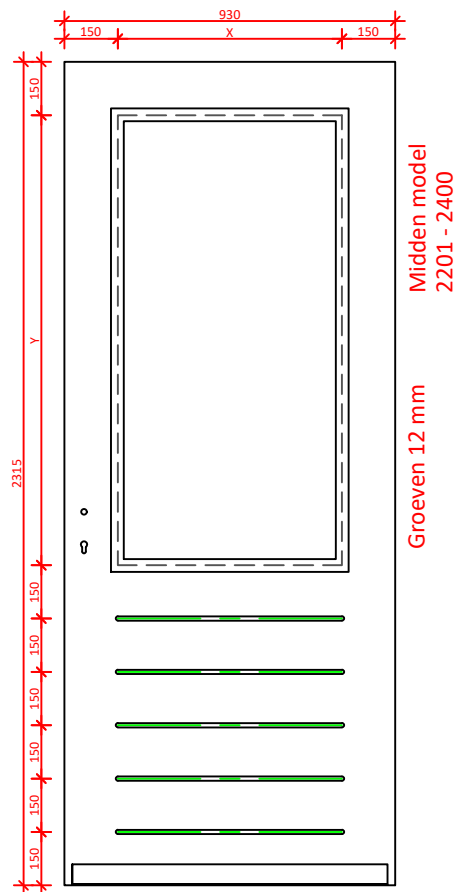
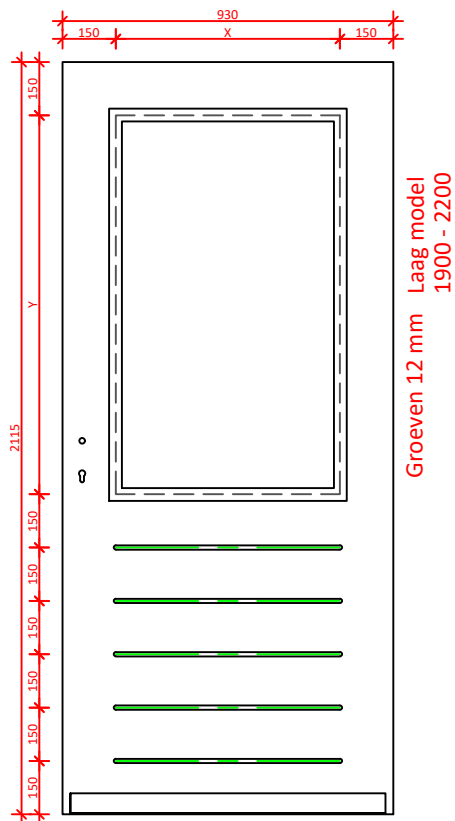



Alleen in KegaPro+ 74 mm.

DATUM:	GEWIJZIGD:	CALCULATIENR:	TEKENINGNR: 9772	MODEL: 9772	HOUTSOORT:
--------	------------	---------------	---------------------	----------------	------------

	KLANT/PROJECT: overzicht modellen 9772 L1 - R4			DCM NUMMER:
--	---	--	--	-------------

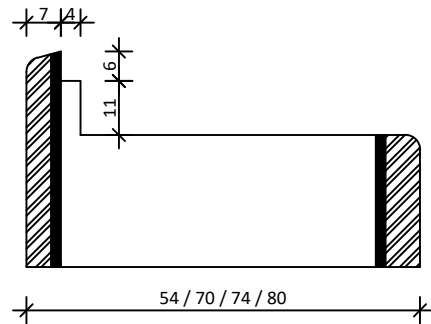
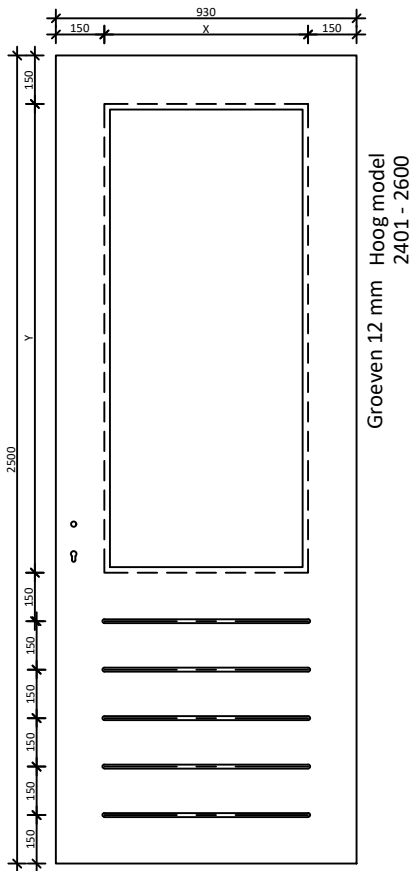
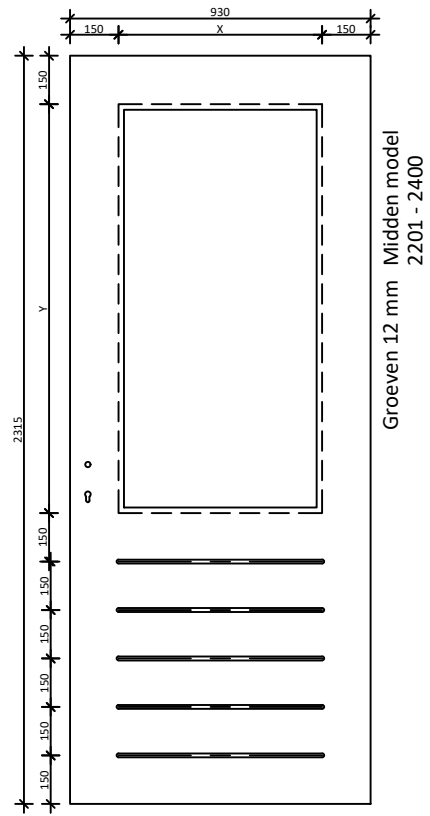
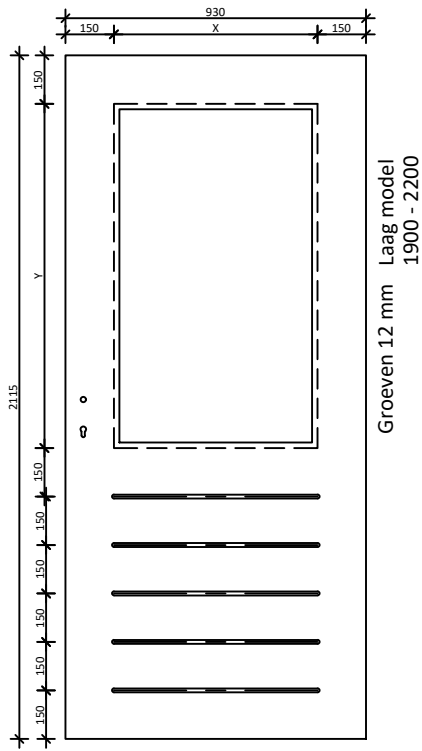
AANVRAAG:	SCHAAL:	GETEKEND:	LEVERWEEK:	1.2a P.73
-----------	---------	-----------	------------	-----------



DATUM: 01-02-23	GEWIJZIGD:	CALCULATIENR:	TEKENINGNR: 9772DPN	MODEL: 9772DPN	HOUTSOORT:
			KLANT/PROJECT: Modellen overzicht		DCM NUMMER:
AANVRAAG:		SCHAAL:	GETEKEND: PN	LEVERWEEK: 1.2a P.74	

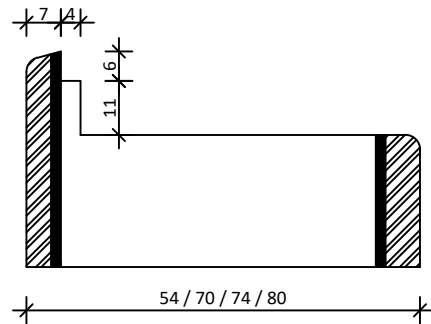
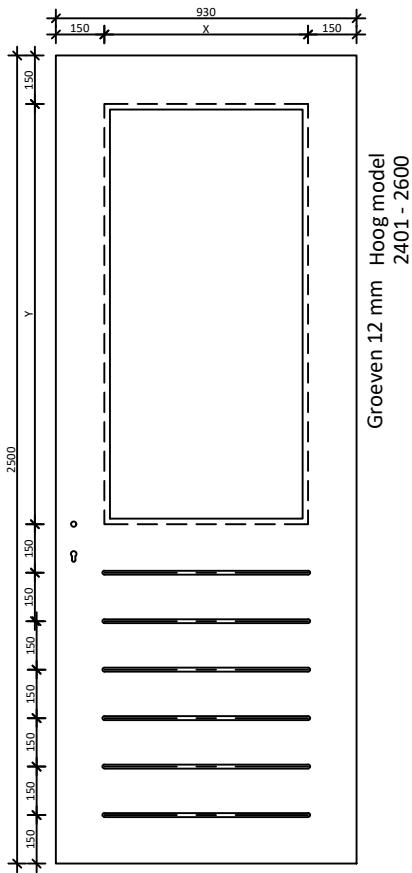
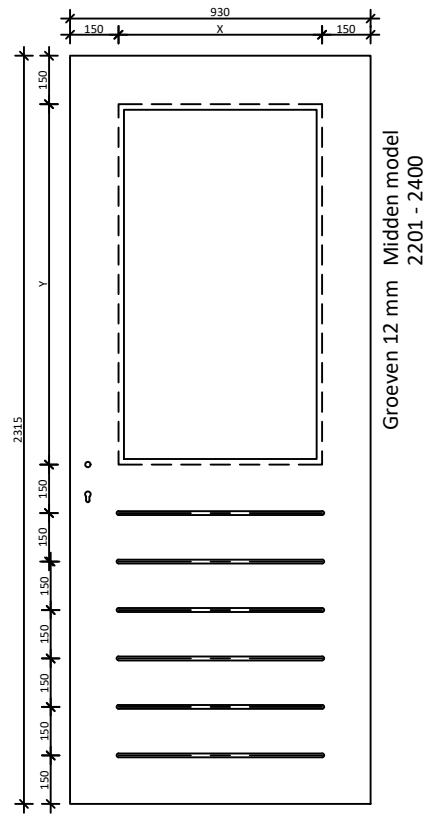
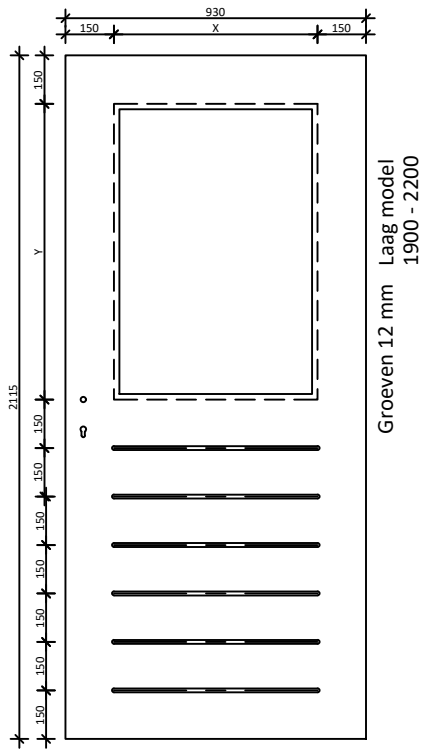

DATUM: 01-02-23	GEWIJZIGD:	CALCULATIENR:	TEKENINGNR: 9773DPN	MODEL: 9773DPN	HOUSOORT:
			KLANT/PROJECT: Modellen overzicht		DCM NUMMER:
			AANVRAAG:	SCHAAL:	GETEKEND: PN

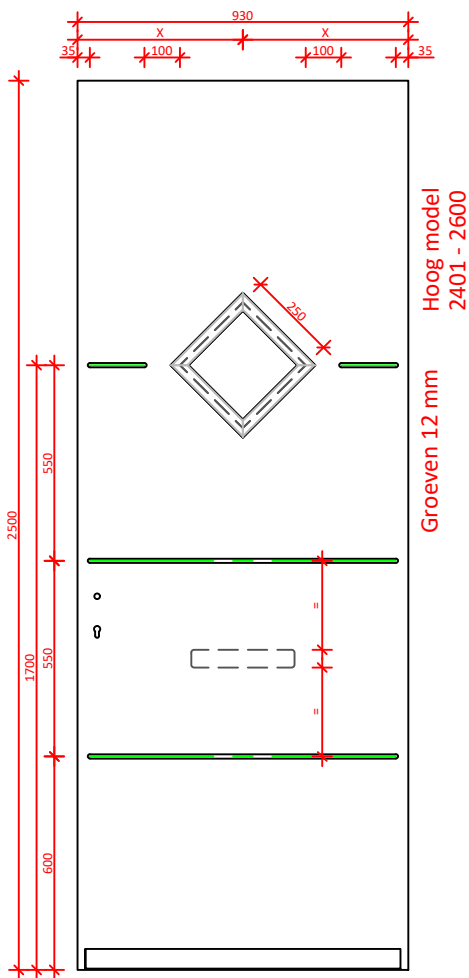
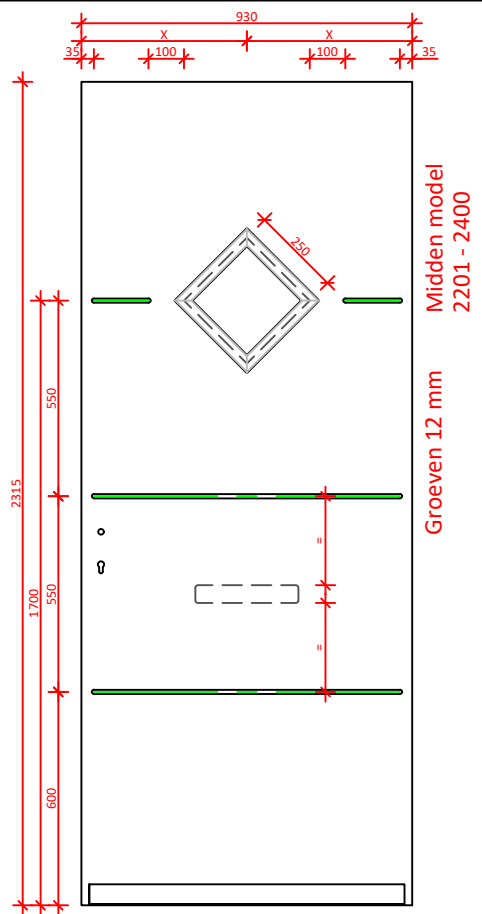
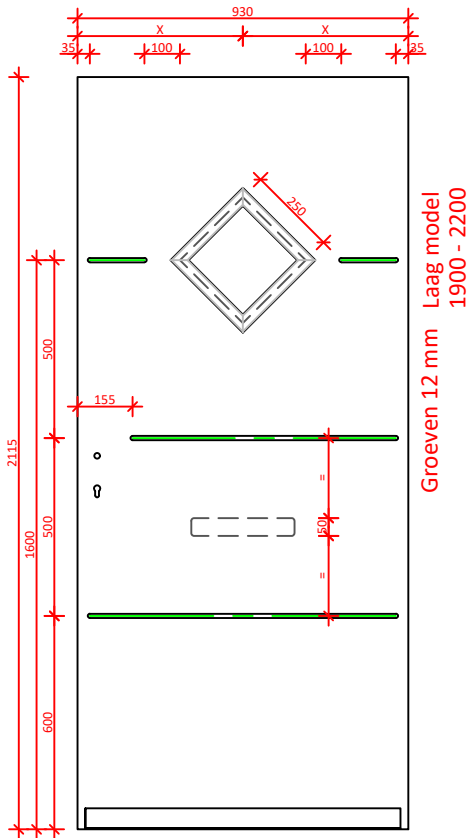

DATUM:	GEWIJZIGD:	CALCULATIENR:	TEKENINGNR:	MODEL: 9801N	HOUTSOORT:
--------	------------	---------------	-------------	-----------------	------------

	KLANT/PROJECT: overzicht modellen 9801N met briefsleuf			DCM NUMMER:
--	---	--	--	-------------

AANVRAAG:	SCHAAL:	GETEKEND: MN	LEVERWEEK: 1.2a P.76
-----------	---------	-----------------	-------------------------

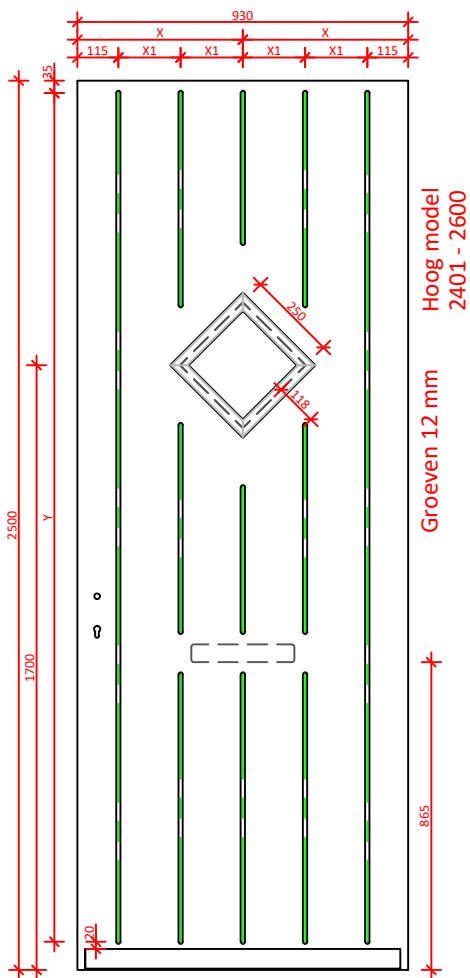
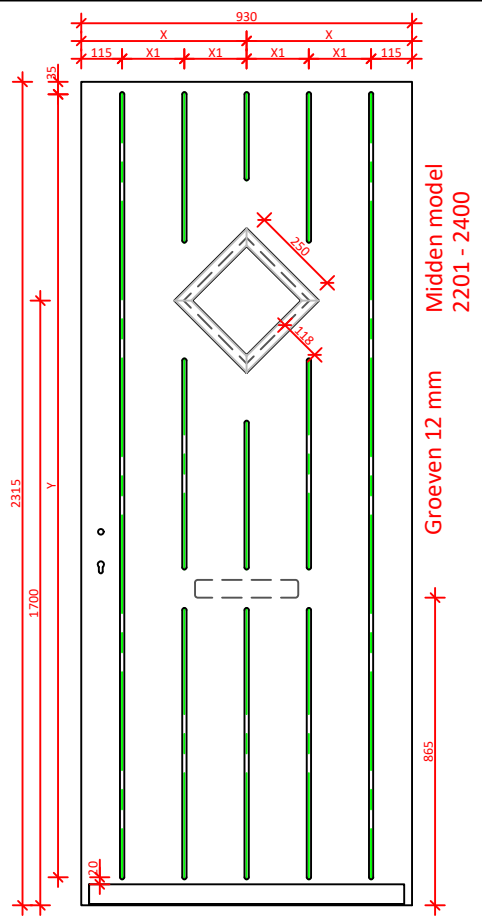
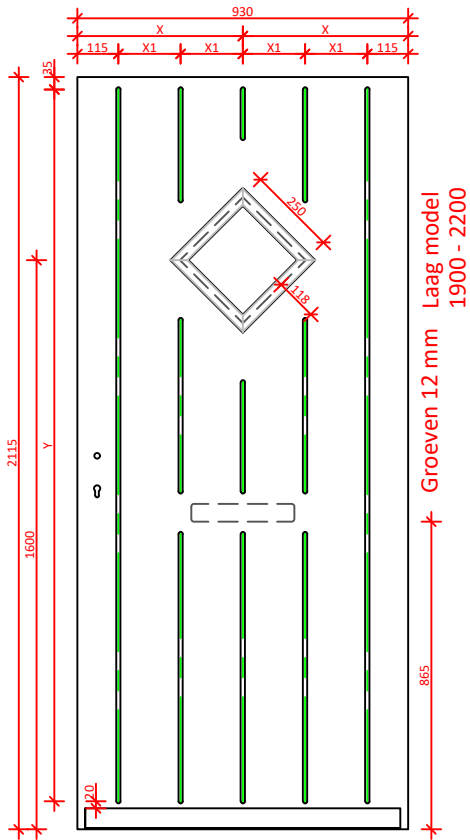

DATUM:	GEWIJZIGD:	CALCULATIENR:	TEKENINGNR:	MODEL: 9802N	HOUTSOORT:
--------	------------	---------------	-------------	-----------------	------------

	KLANT/PROJECT: overzicht modellen 9802N met briefsleuf			DCM NUMMER:
--	---	--	--	-------------

AANVRAAG:	SCHAAL:	GETEKEND: MN	LEVERWEEK: 1.2a P.77
-----------	---------	-----------------	-------------------------

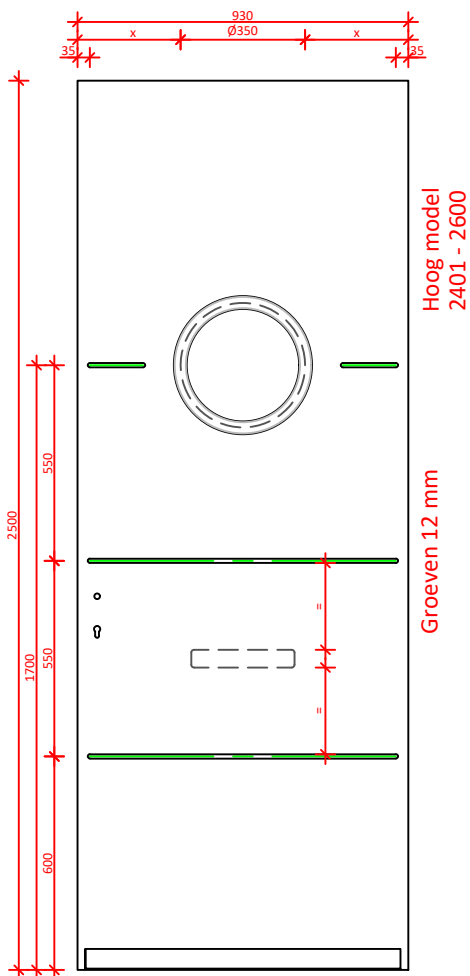
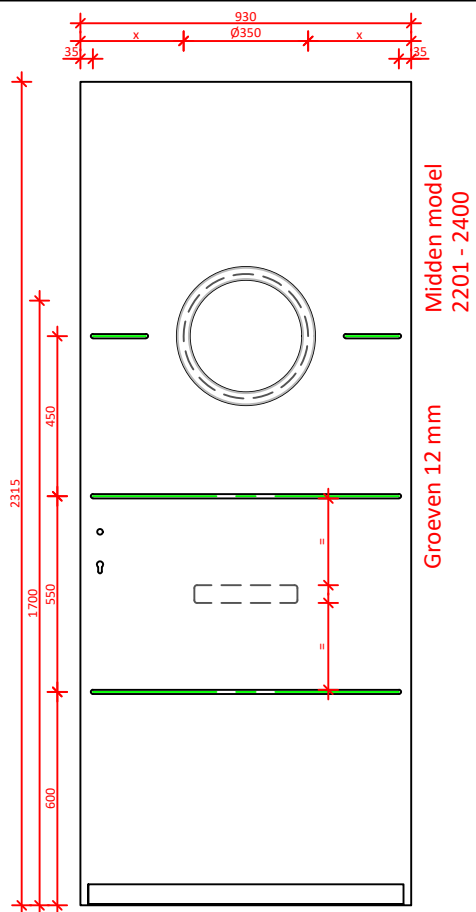
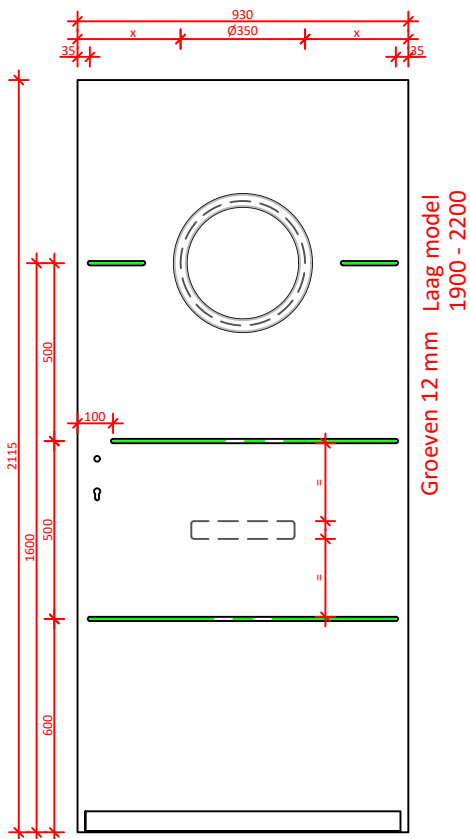

DATUM:	GEWIJZIGD:	CALCULATIENR:	TEKENINGNR: 9807N	MODEL:	HOUTSOORT:
--------	------------	---------------	----------------------	--------	------------

	KLANT/PROJECT: overzicht modellen 9807N			DCM NUMMER:
--	--	--	--	-------------

AANVRAAG:	SCHAAL:	GETEKEND:	LEVERWEEK:	1.2a P.78
-----------	---------	-----------	------------	-----------

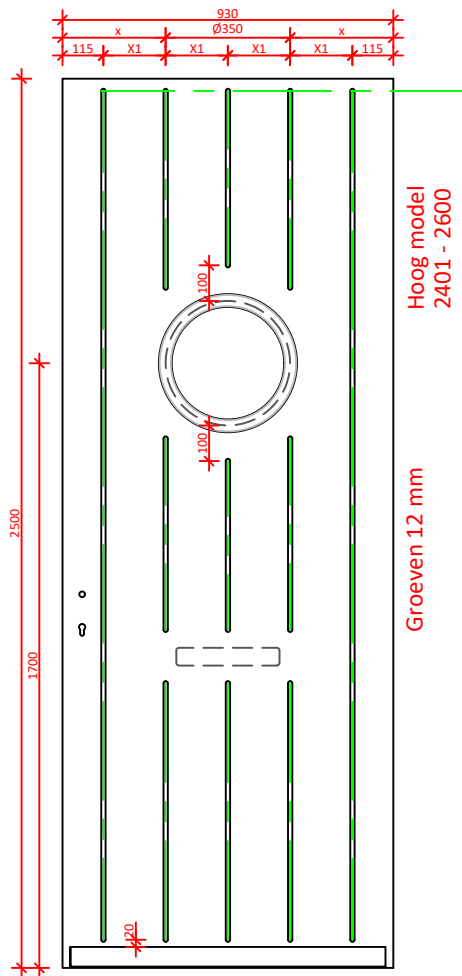
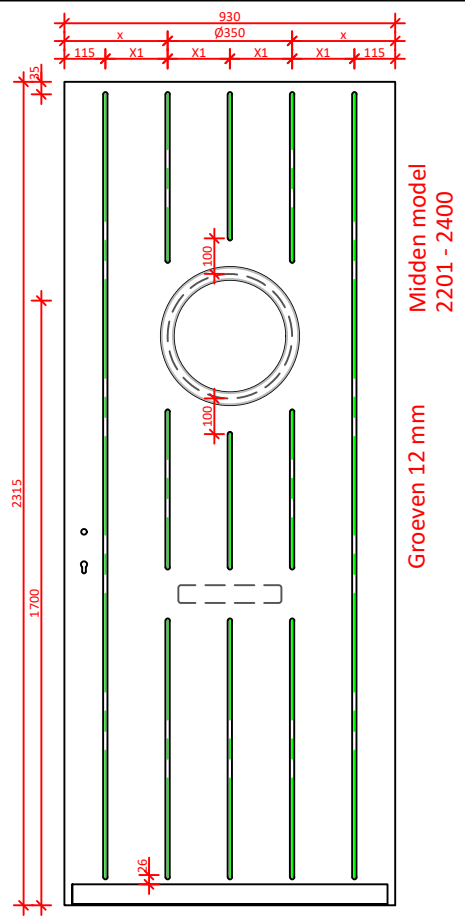
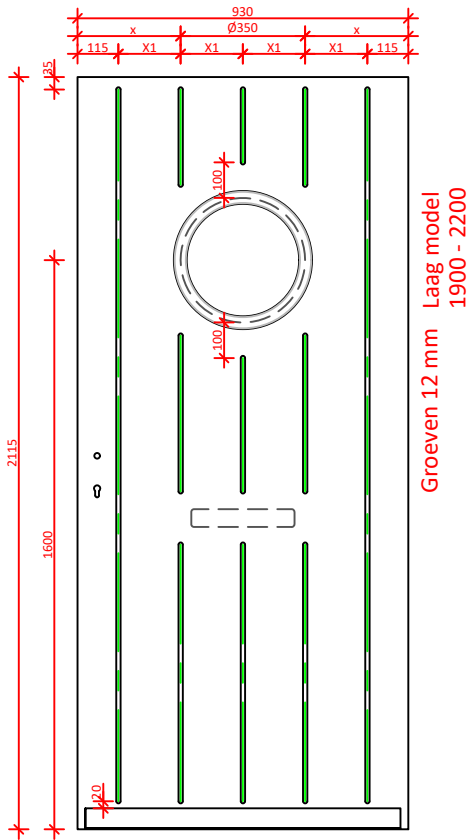

DATUM:	GEWIJZIGD:	CALCULATIENR:	TEKENINGNR: 9808N	MODEL:	HOUTSOORT:
--------	------------	---------------	----------------------	--------	------------

KLANT/PROJECT: overzicht modellen 9808N met briefsleuf			DCM NUMMER:		
AANVRAAG:	SCHAAL:	GETEKEND:	LEVERWEEK:	1.2a P.79	

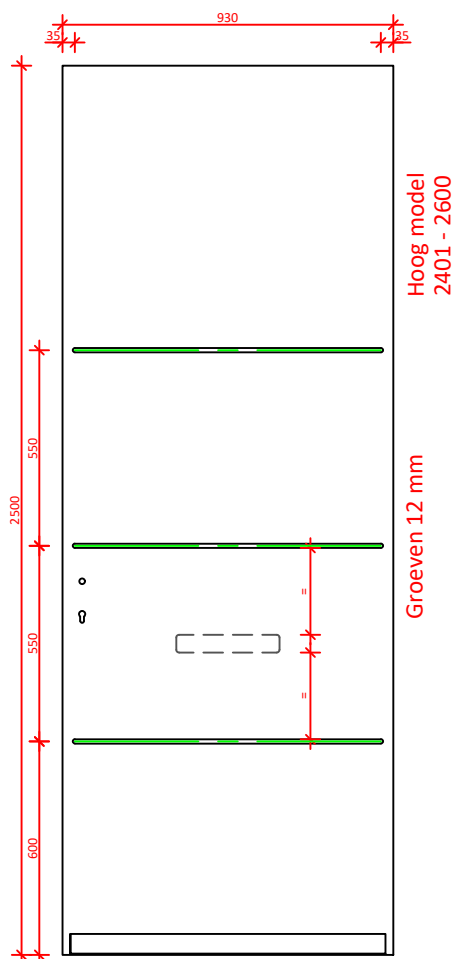
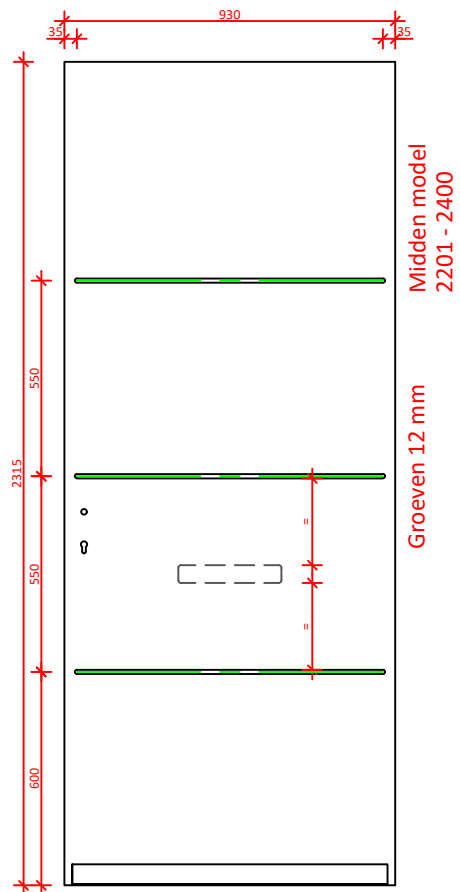
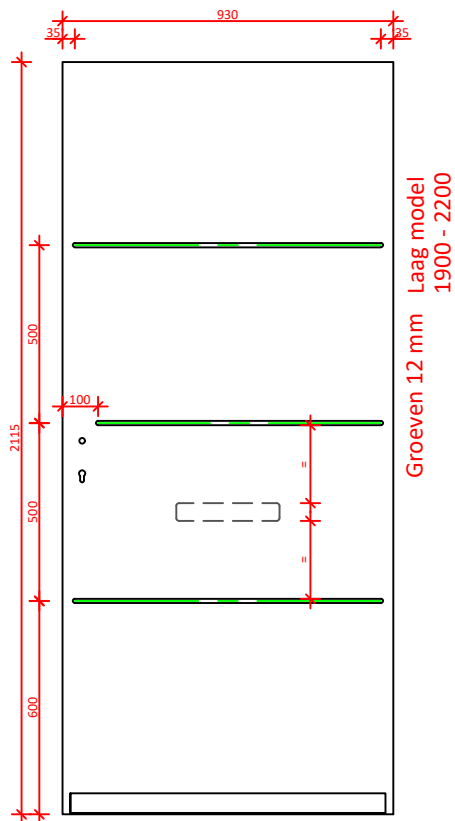

DATUM:	GEWIJZIGD:	CALCULATIENR:	TEKENINGNR: 9813N	MODEL:	HOUTSOORT:
--------	------------	---------------	----------------------	--------	------------

KEGRO DEUREN	KLANT/PROJECT: overzicht modellen 9813N			DCM NUMMER:	
-----------------------	--	--	--	-------------	--

AANVRAAG:	SCHAAL:	GETEKEND:	LEVERWEEK:	1.2a P.80
-----------	---------	-----------	------------	-----------

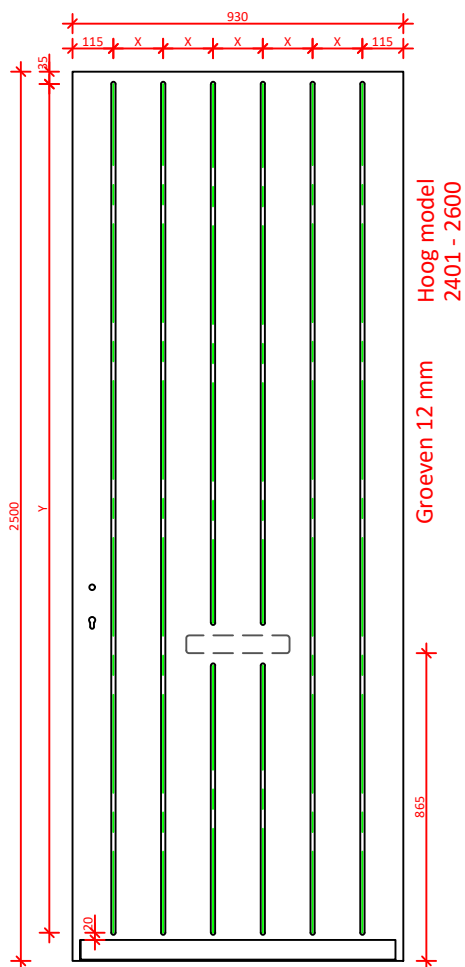
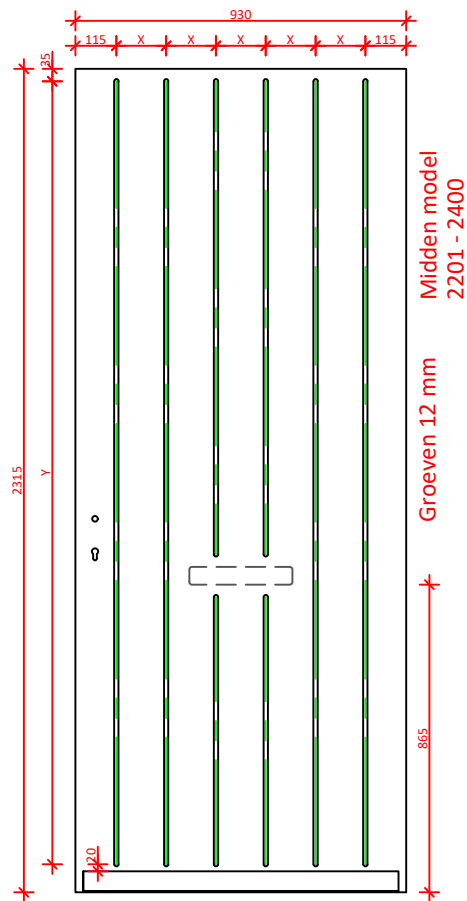
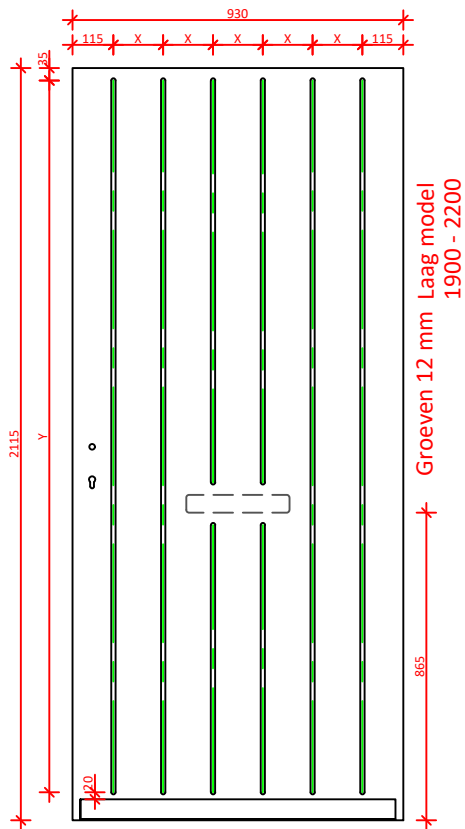

DATUM:	GEWIJZIGD:	CALCULATIENR:	TEKENINGNR:	MODEL: 9814	HOUTSOORT:
--------	------------	---------------	-------------	----------------	------------

KEGRO DEUREN	KLANT/PROJECT: overzicht modellen 9814			DCM NUMMER:
-----------------------	---	--	--	-------------

AANVRAAG:	SCHAAL:	GETEKEND: MN	LEVERWEEK: 1.2a P.81
-----------	---------	-----------------	-------------------------

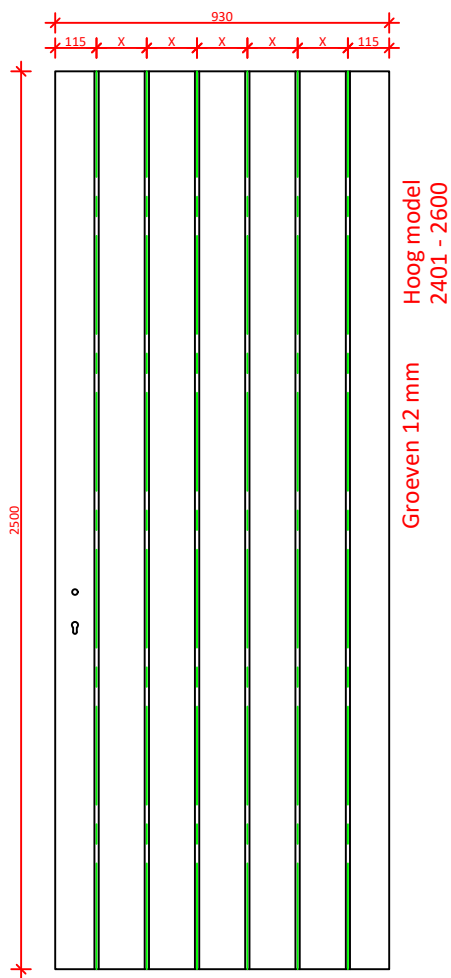
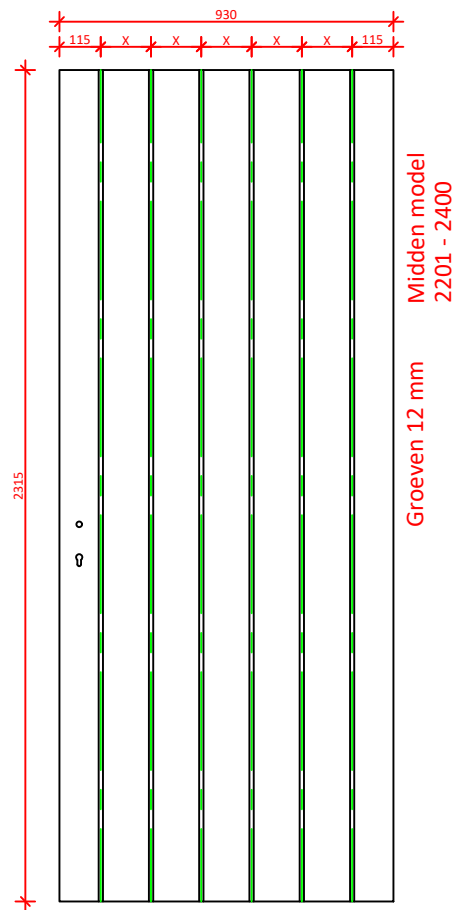
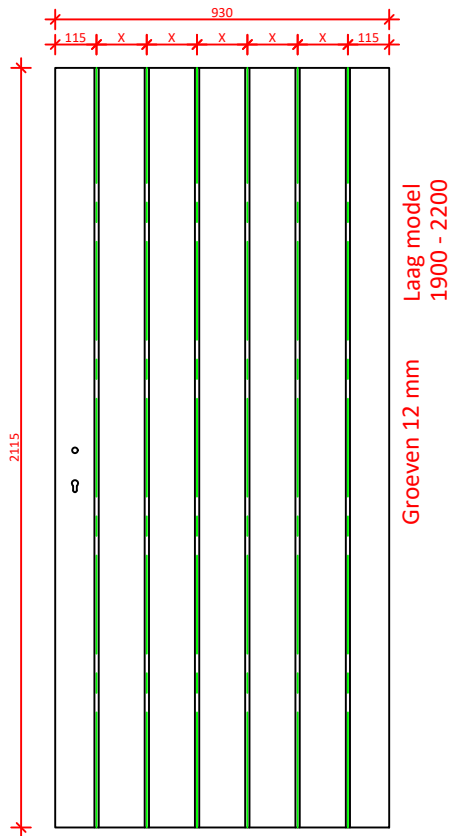

DATUM:	GEWIJZIGD:	CALCULATIENR:	TEKENINGNR: 9815	MODEL: 9815	HOUTSOORT:
--------	------------	---------------	---------------------	----------------	------------

	KLANT/PROJECT: overzicht modellen 9815			DCM NUMMER:
--	---	--	--	-------------

AANVRAAG:	SCHAAL:	GETEKEND: MN	LEVERWEEK: 1.2a P.82
-----------	---------	-----------------	-------------------------

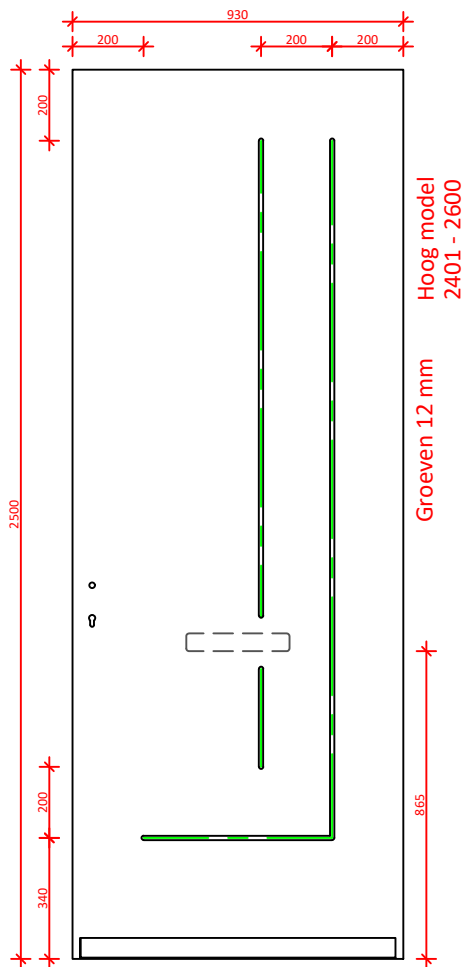
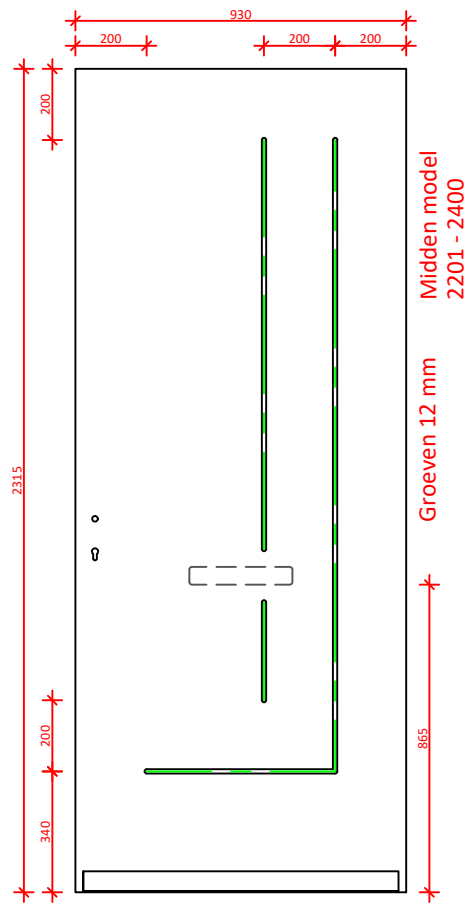
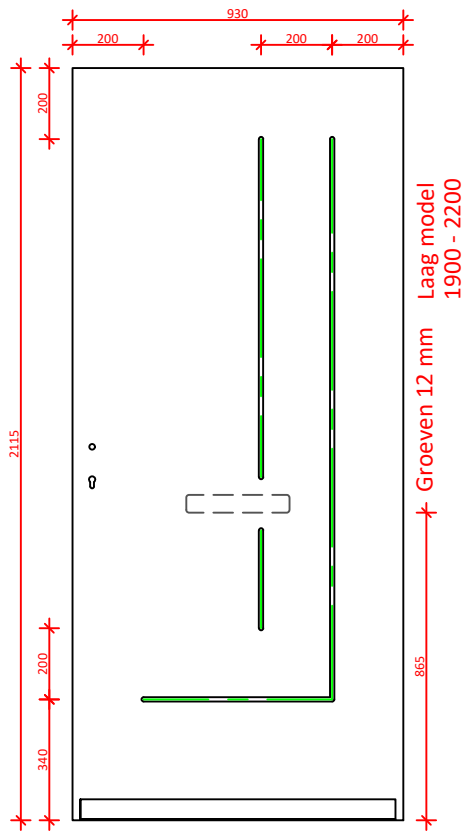

DATUM:	GEWIJZIGD:	CALCULATIENR:	TEKENINGNR:	MODEL: 9816	HOUTSOORT:
--------	------------	---------------	-------------	----------------	------------

	KLANT/PROJECT: overzicht modellen 9816 met briefsleuf			DCM NUMMER:
--	--	--	--	-------------

AANVRAAG:	SCHAAL:	GETEKEND: MN	LEVERWEEK: 1.2a P.83
-----------	---------	-----------------	-------------------------

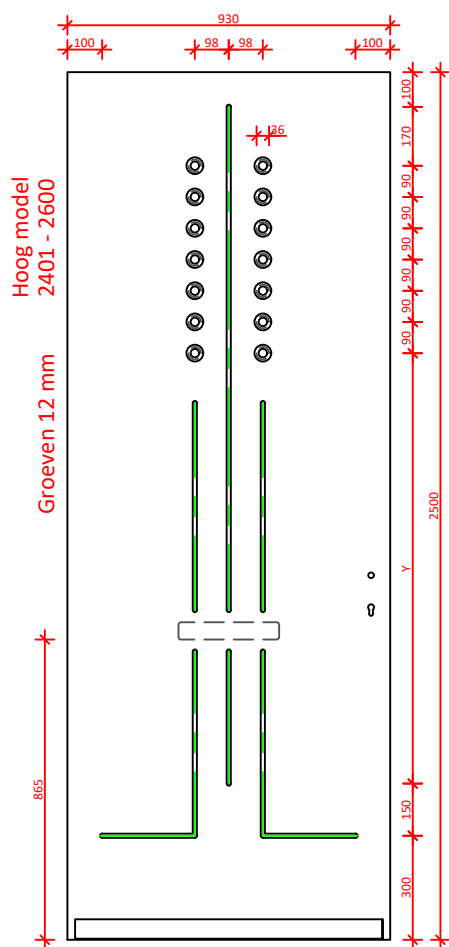
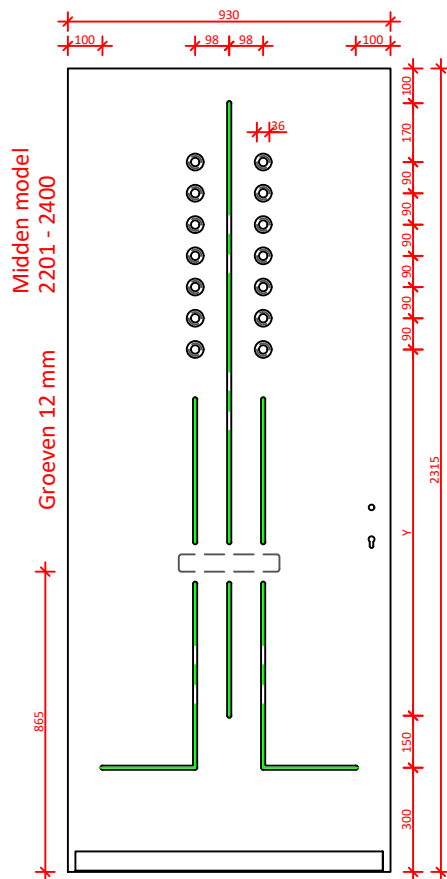
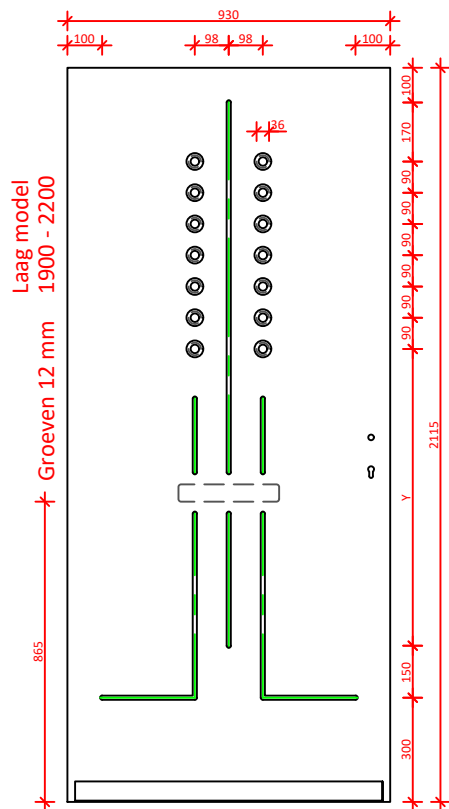

DATUM:	GEWIJZIGD:	CALCULATIENR:	TEKENINGNR:	MODEL: 9817	HOUTSOORT:
--------	------------	---------------	-------------	----------------	------------

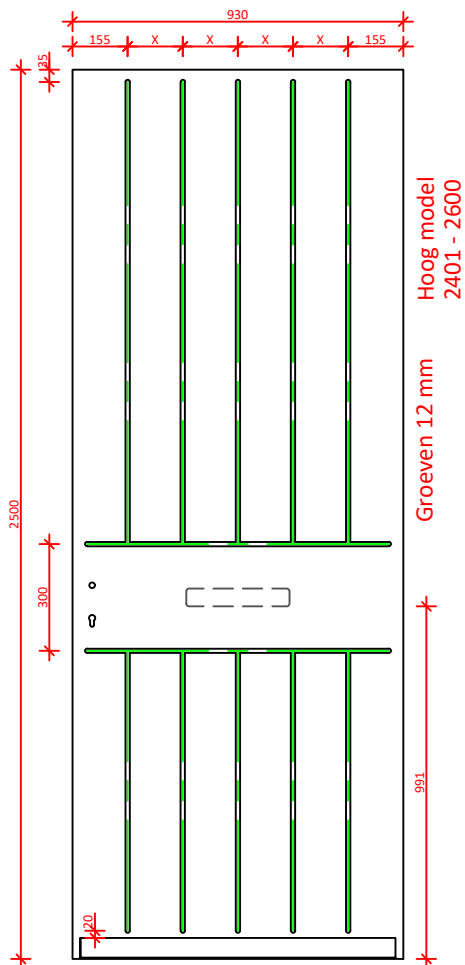
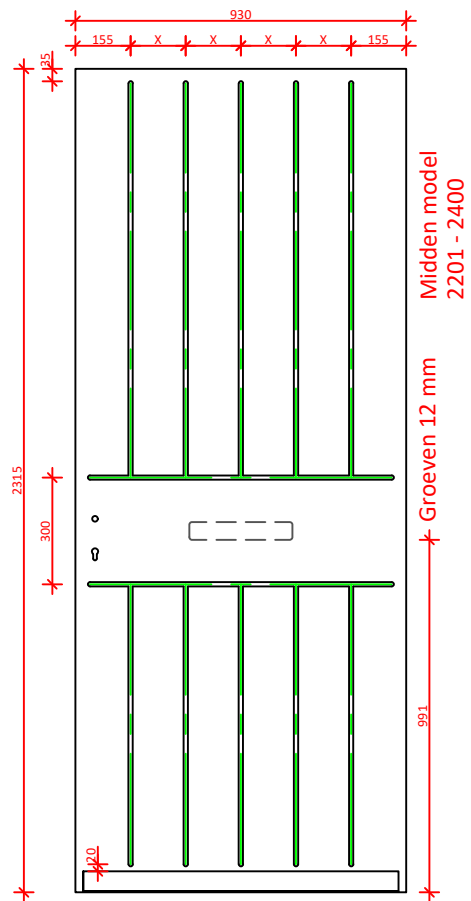
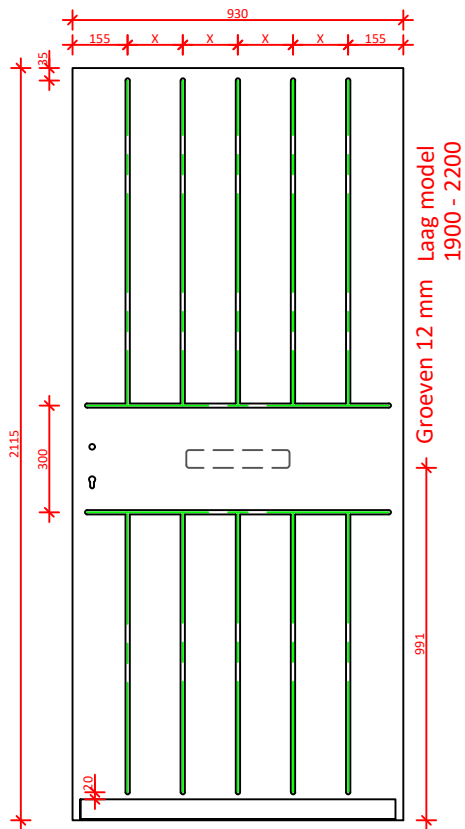

DATUM:	GEWIJZIGD:	CALCULATIENR:	TEKENINGNR:	MODEL: 9821	HOUTSOORT:
--------	------------	---------------	-------------	----------------	------------

	KLANT/PROJECT: overzicht modellen 9821			DCM NUMMER:
--	---	--	--	-------------

AANVRAAG:	SCHAAL:	GETEKEND: MN	LEVERWEEK: 1.2a P.85
-----------	---------	-----------------	-------------------------

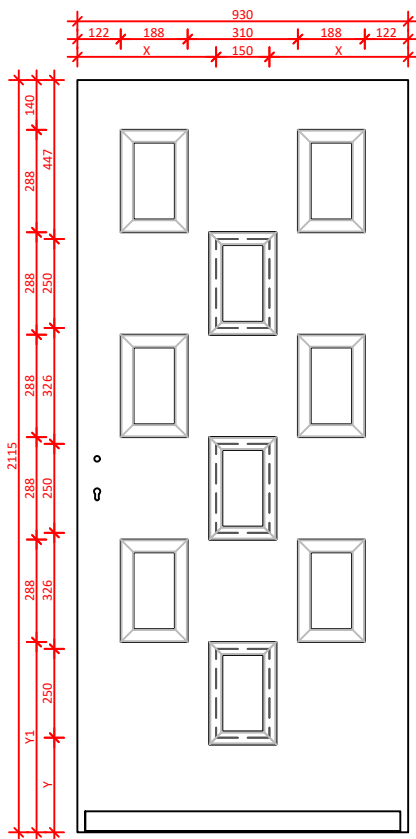

Laag model
1900 - 2200

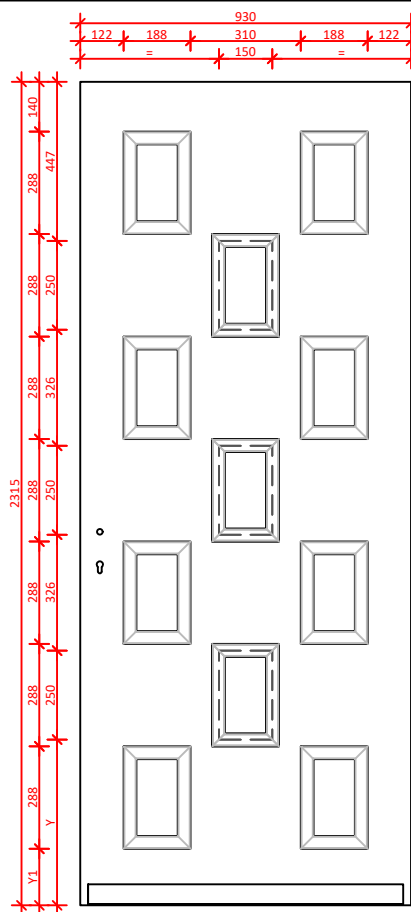

Midden model
2201 - 2400

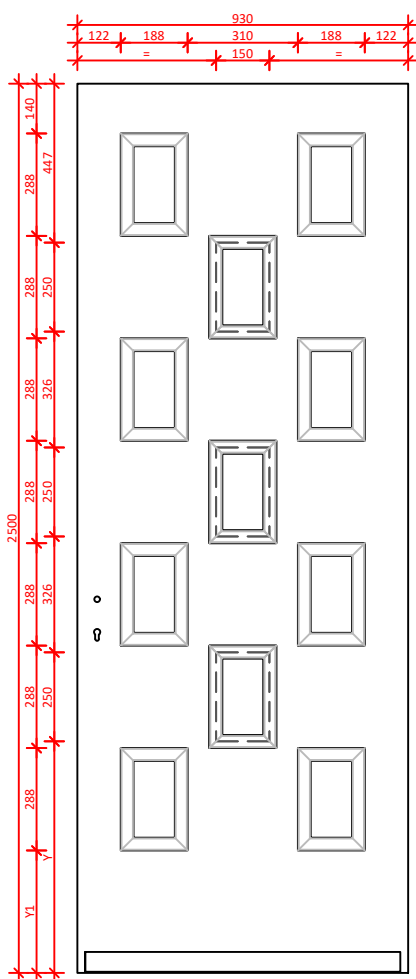

Hoog model
2401 - 2600

DATUM:	GEWIJZIGD:	CALCULATIENR:	TEKENINGNR:	MODEL: 9823N	HOUTSOORT:
--------	------------	---------------	-------------	-----------------	------------

	KLANT/PROJECT: overzicht modellen 9823N			DCM NUMMER:
--	--	--	--	-------------

AANVRAAG:	SCHAAL:	GETEKEND: MN	LEVERWEEK: 1.2a P.86
-----------	---------	-----------------	-------------------------

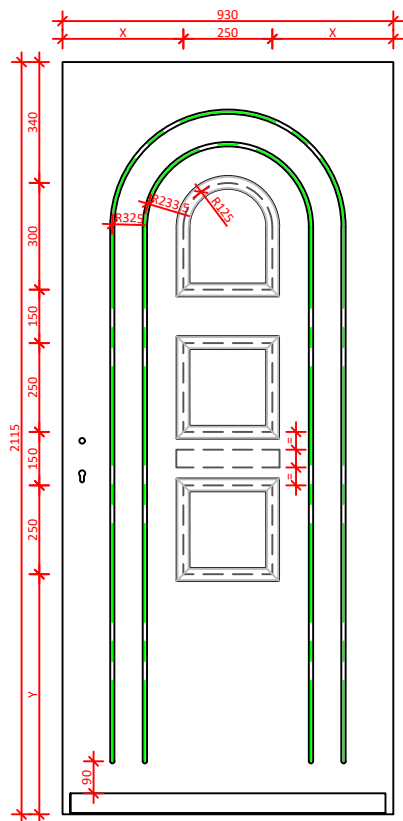

Groeven 12 mm Laag model
1900 - 2200

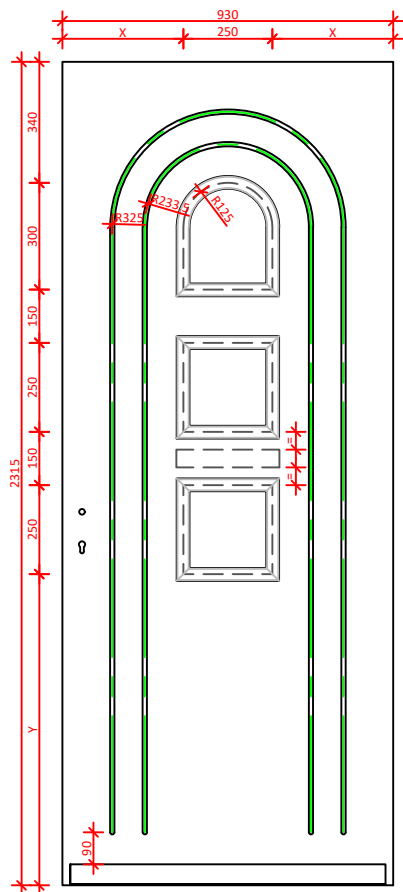

Groeven 12 mm Midden model
2201 - 2400

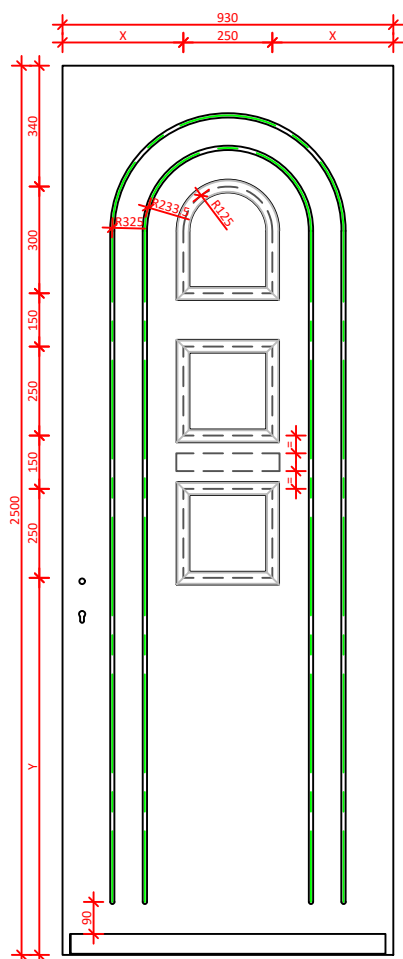

Groeven 12 mm Hoog model
2401 - 2600

DATUM:	GEWIJZIGD:	CALCULATIENR:	TEKENINGNR:	MODEL: 9825N	HOUTSOORT:
--------	------------	---------------	-------------	-----------------	------------

KEGRO DEUREN	KLANT/PROJECT: overzicht modellen 9825N			DCM NUMMER:
-----------------------	--	--	--	-------------

AANVRAAG:	SCHAAL:	GETEKEND: MN	LEVERWEEK: 1.2a P.87
-----------	---------	-----------------	-------------------------

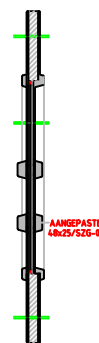
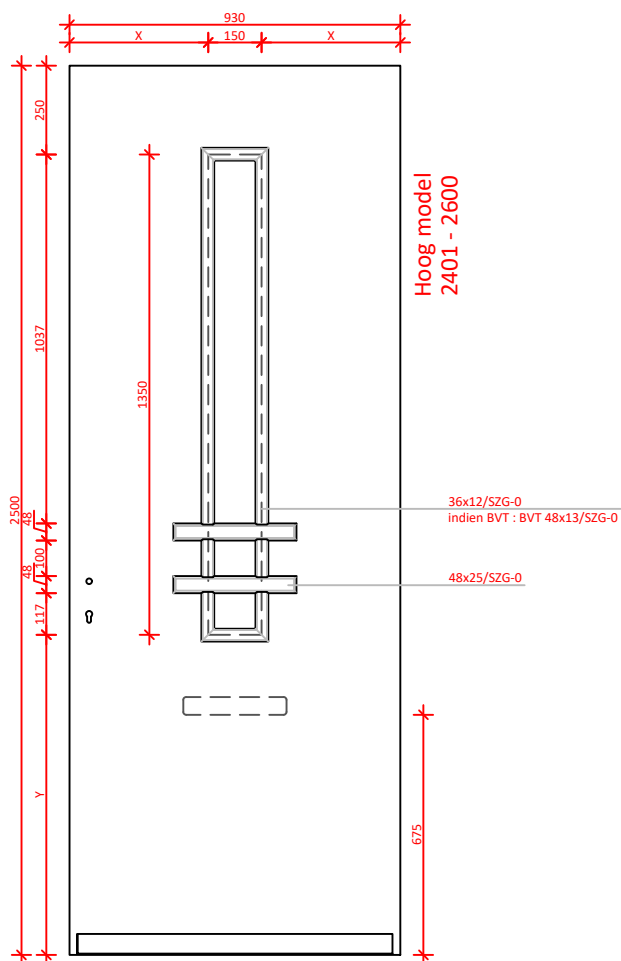
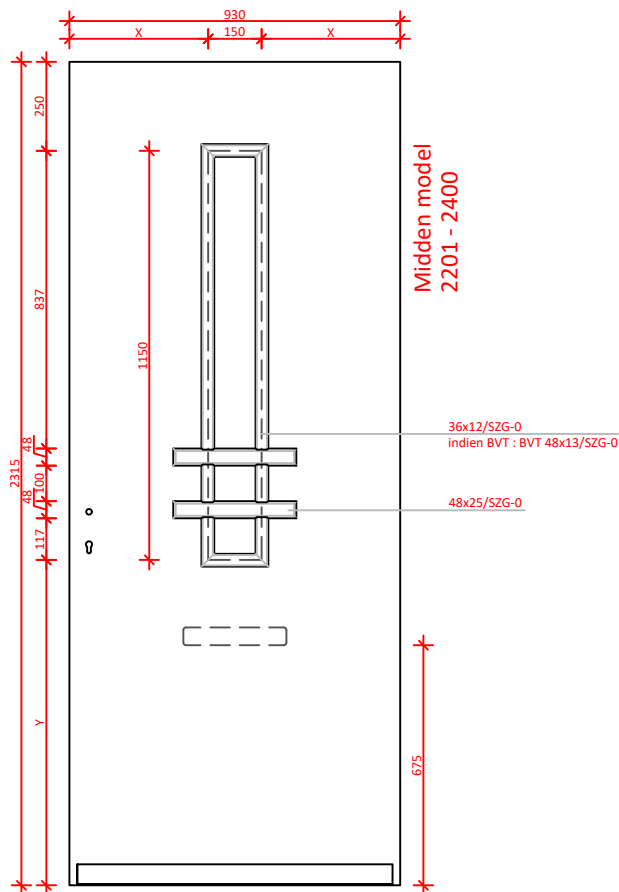
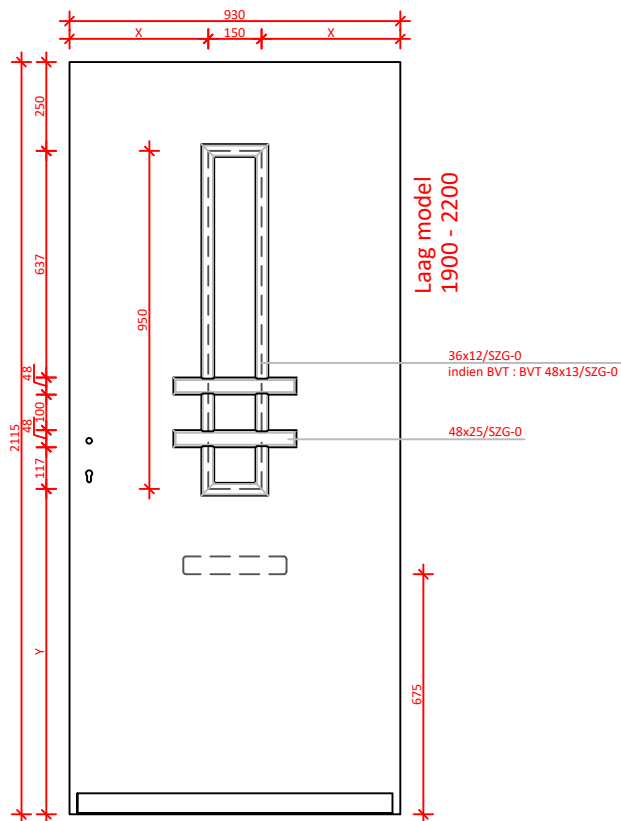

DATUM:	GEWIJZIGD:	CALCULATIENR:	TEKENINGNR: 9828N	MODEL:	HOUTSOORT:
--------	------------	---------------	----------------------	--------	------------

KEGRO DEUREN	KLANT/PROJECT: overzicht modellen 9828N			DCM NUMMER:
-----------------------	--	--	--	-------------

AANVRAAG:	SCHAAL:	GETEKEND:	LEVERWEEK:	1.2a P.88
-----------	---------	-----------	------------	-----------

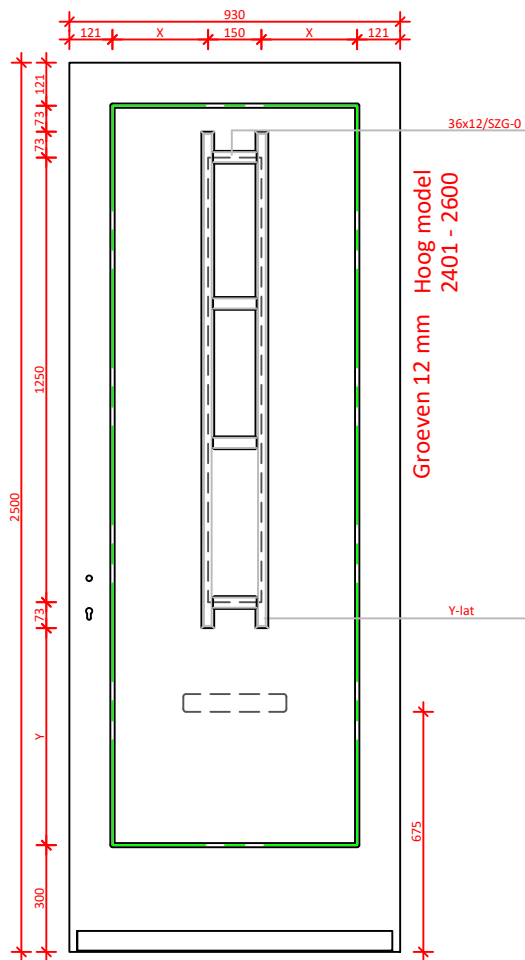
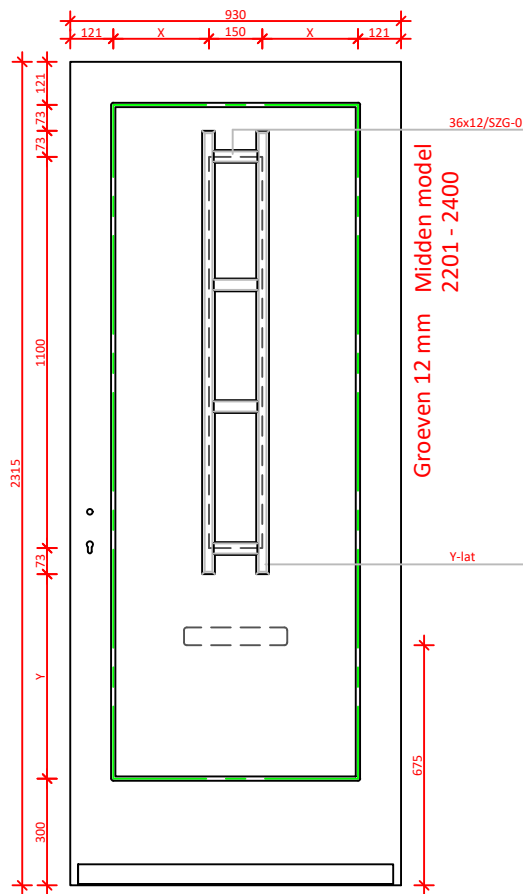
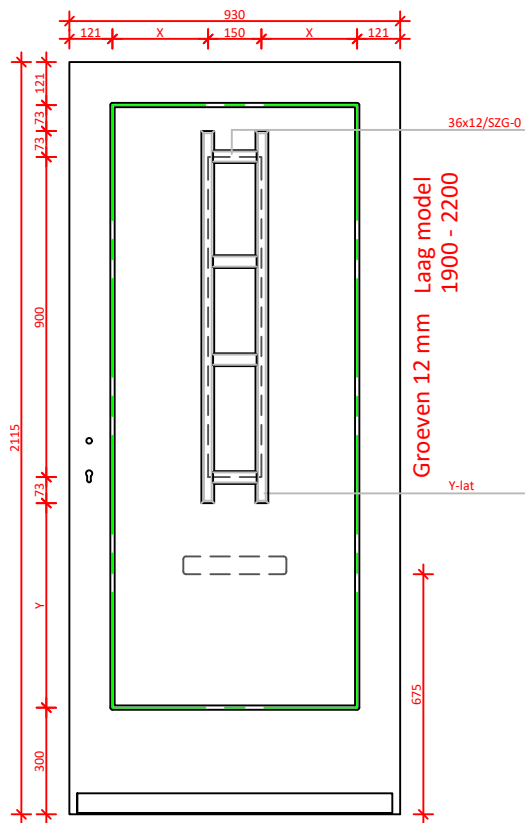

DATUM:	GEWIJZIGD:	CALCULATIENR:	TEKENINGNR: 9829N	MODEL:	HOUTSOORT:
--------	------------	---------------	----------------------	--------	------------

	KLANT/PROJECT: overzicht modellen 9829N			DCM NUMMER:
--	--	--	--	-------------

AANVRAAG:	SCHAAL:	GETEKEND:	LEVERWEEK:	1.2a P.89
-----------	---------	-----------	------------	-----------

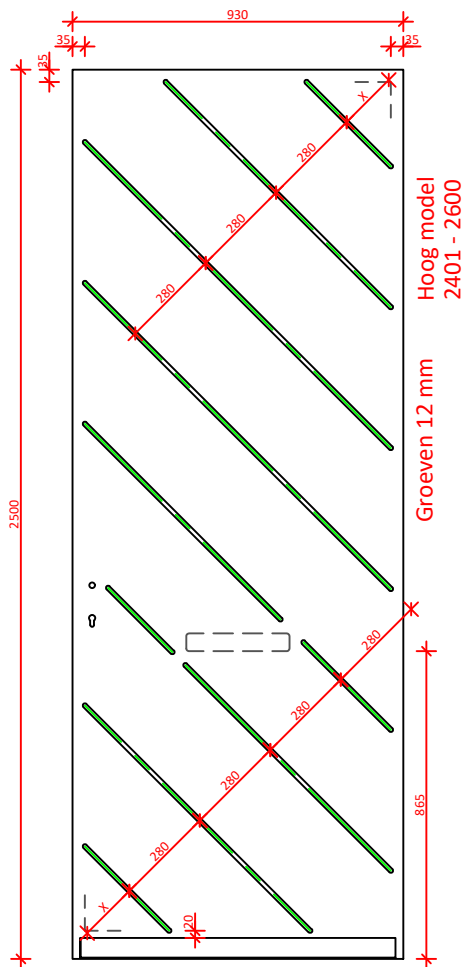
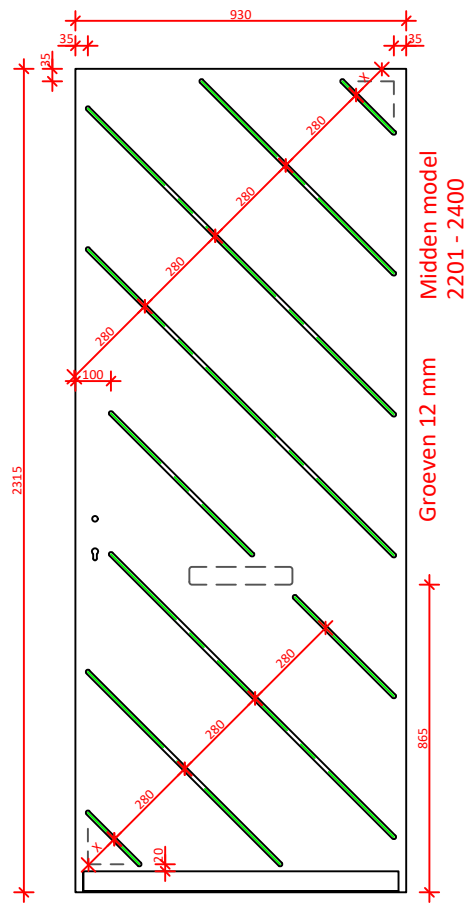
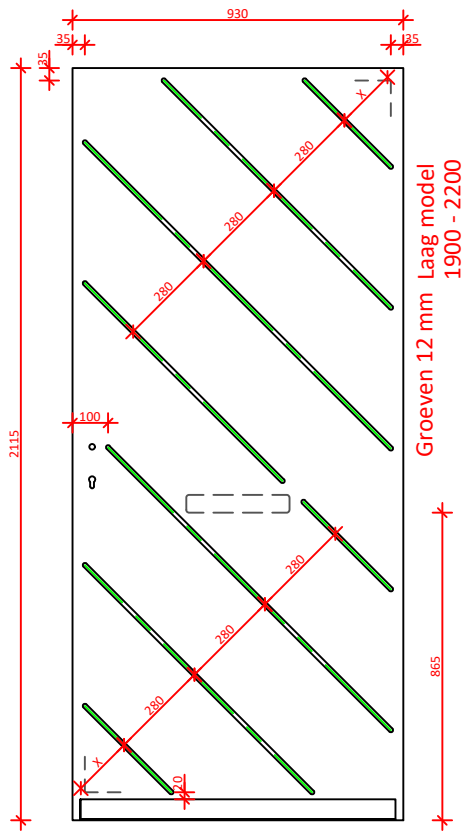

DATUM:	GEWIJZIGD:	CALCULATIENR:	TEKENINGNR:	MODEL: 9830	HOUTSOORT:
--------	------------	---------------	-------------	----------------	------------

	KLANT/PROJECT: overzicht modellen 9830 met briefsleuf			DCM NUMMER:
--	--	--	--	-------------

AANVRAAG:	SCHAAL:	GETEKEND: MN	LEVERWEEK:	1.2a P.90
-----------	---------	-----------------	------------	-----------

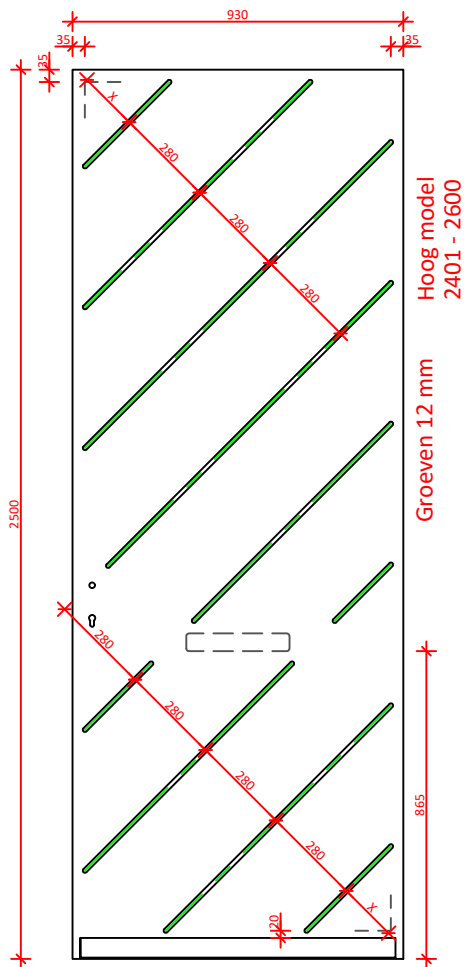
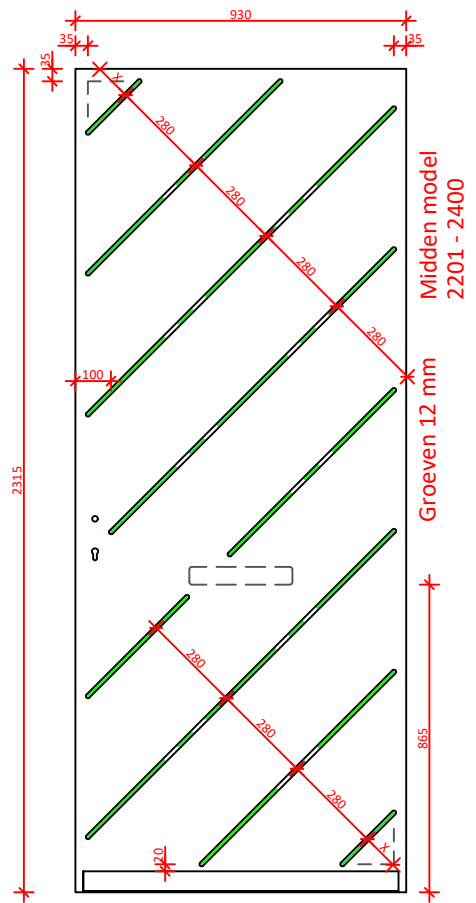
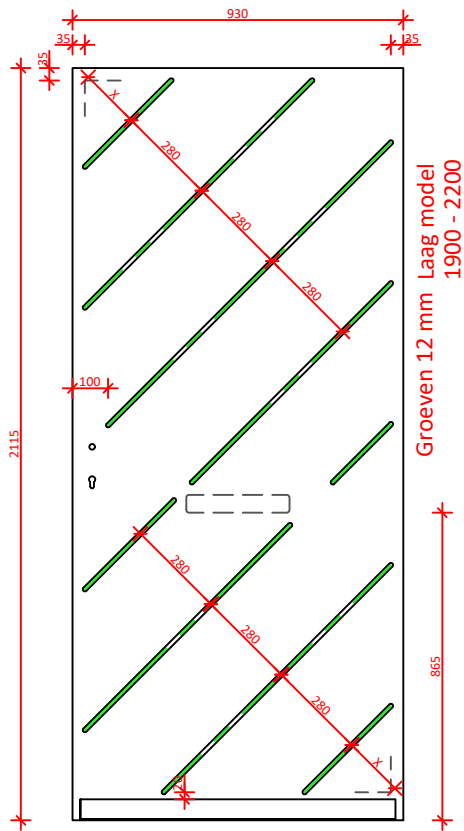

DATUM:	GEWIJZIGD:	CALCULATIENR:	TEKENINGNR:	MODEL: 9831	HOUTSOORT:
--------	------------	---------------	-------------	----------------	------------

	KLANT/PROJECT: overzicht modellen 9831 met briefsleuf			DCM NUMMER:
--	--	--	--	-------------

AANVRAAG:	SCHAAL:	GETEKEND: MN	LEVERWEEK:	1.2a P.91
-----------	---------	-----------------	------------	-----------

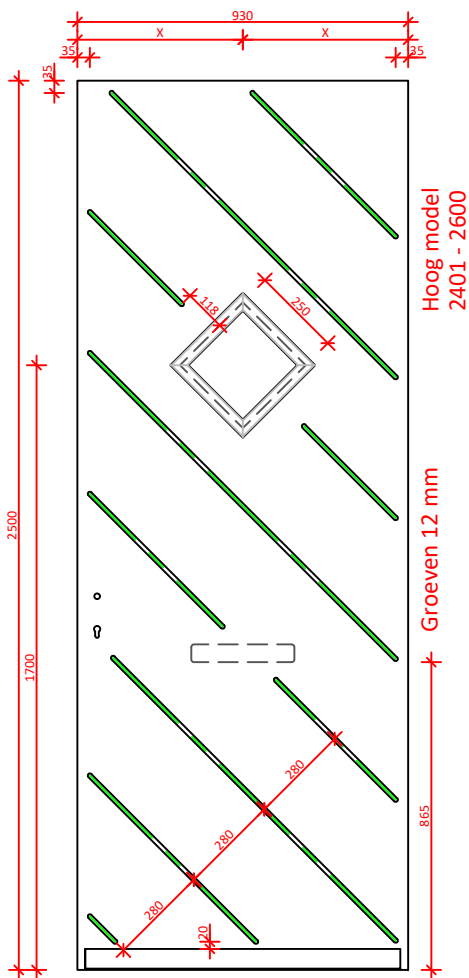
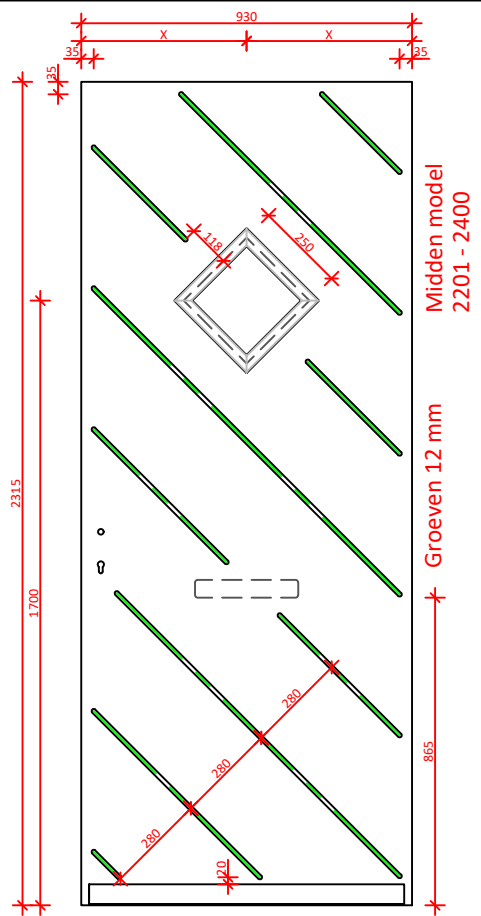
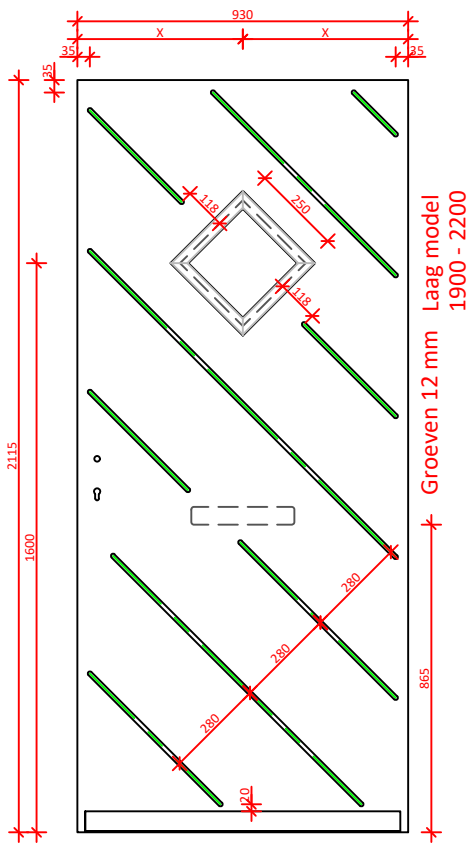

DATUM:	GEWIJZIGD:	CALCULATIENR:	TEKENINGNR:	MODEL: 9832N	HOUTSOORT:
--------	------------	---------------	-------------	-----------------	------------

	KLANT/PROJECT: overzicht modellen 9832N met briefsleuf			DCM NUMMER:
--	---	--	--	-------------

AANVRAAG:	SCHAAL:	GETEKEND: MN	LEVERWEEK:	1.2a P.92
-----------	---------	-----------------	------------	-----------

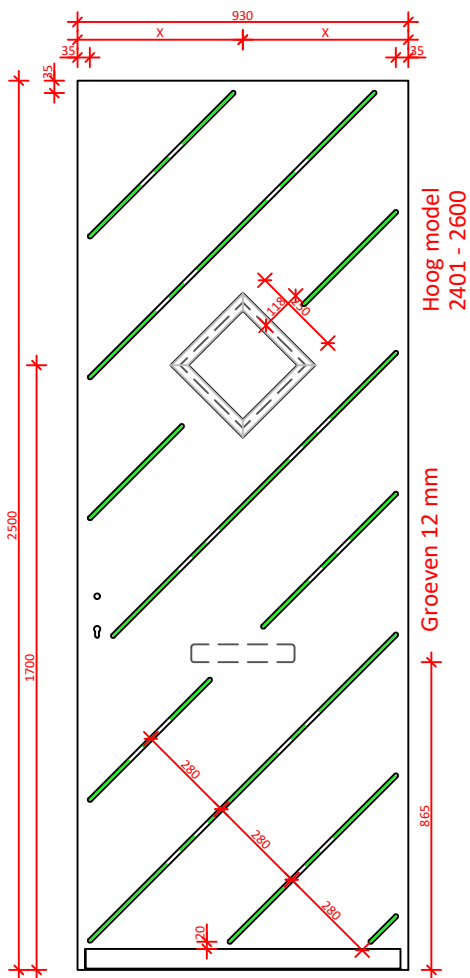
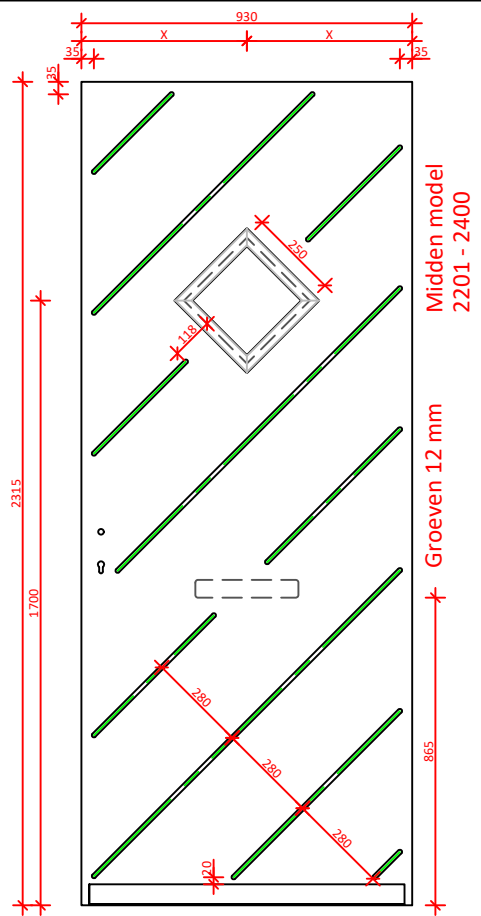
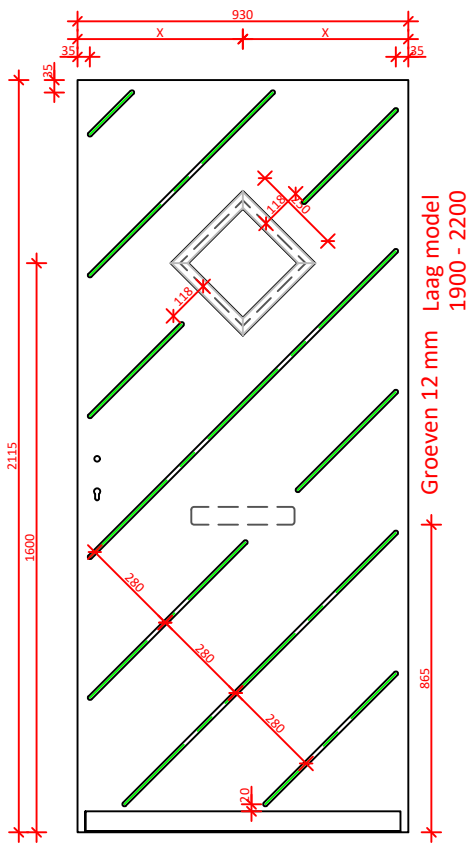

DATUM:	GEWIJZIGD:	CALCULATIENR:	TEKENINGNR:	MODEL: 9833N	HOUTSOORT:
--------	------------	---------------	-------------	-----------------	------------

	KLANT/PROJECT: overzicht modellen 9833N met briefsleuf			DCM NUMMER:
--	---	--	--	-------------

AANVRAAG:	SCHAAL:	GETEKEND: MN	LEVERWEEK:	1.2a P.93
-----------	---------	-----------------	------------	-----------

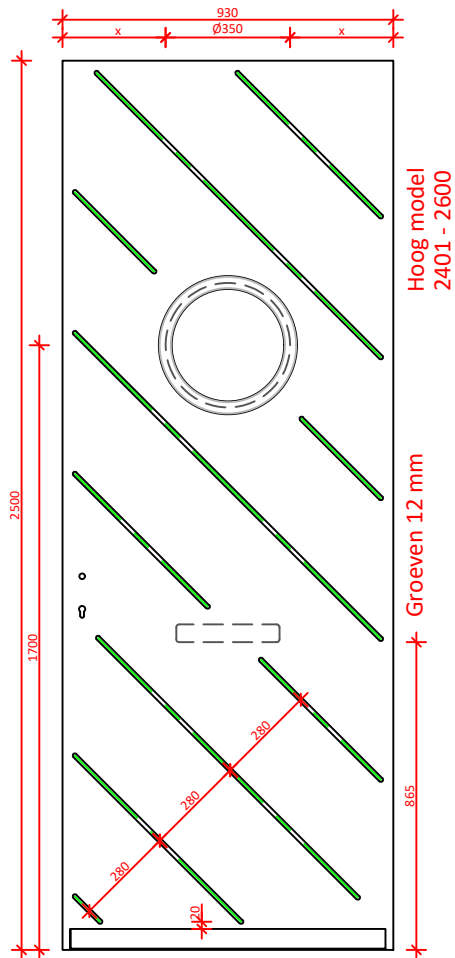
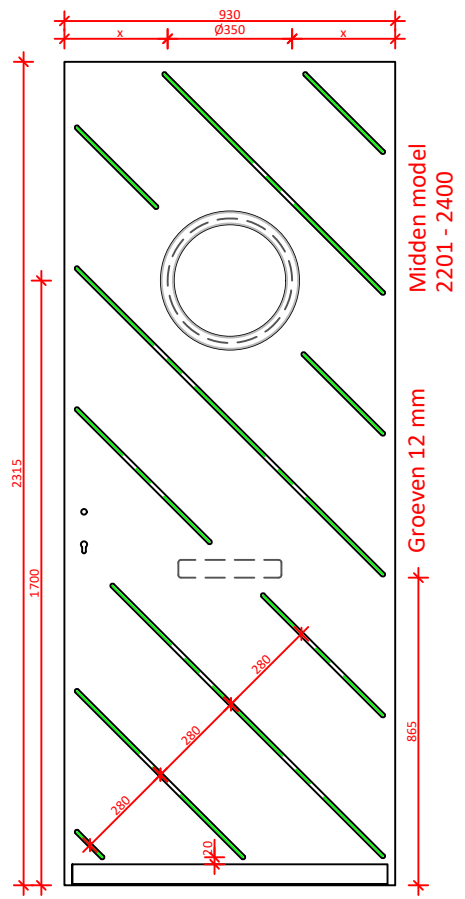
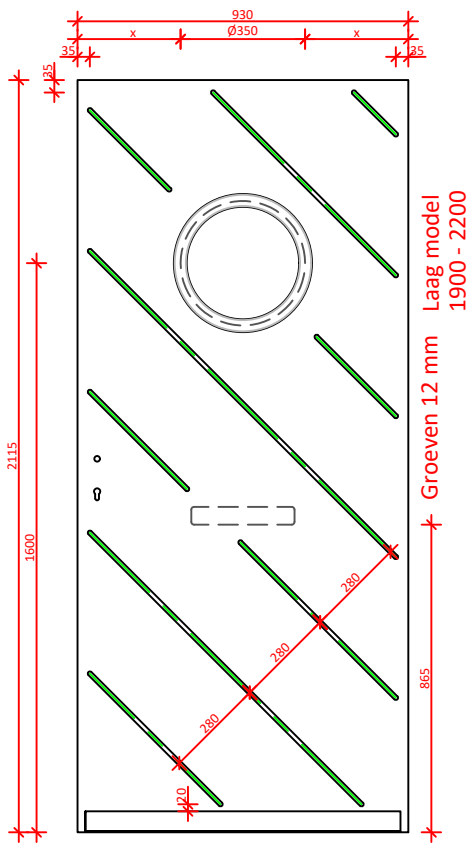

DATUM:	GEWIJZIGD:	CALCULATIENR:	TEKENINGNR: 9834N	MODEL:	HOUTSOORT:
			KLANT/PROJECT: overzicht modellen 9834N met briefleuf		DCM NUMMER:
			AANVRAAG:	SCHAAL:	GETEKEND:

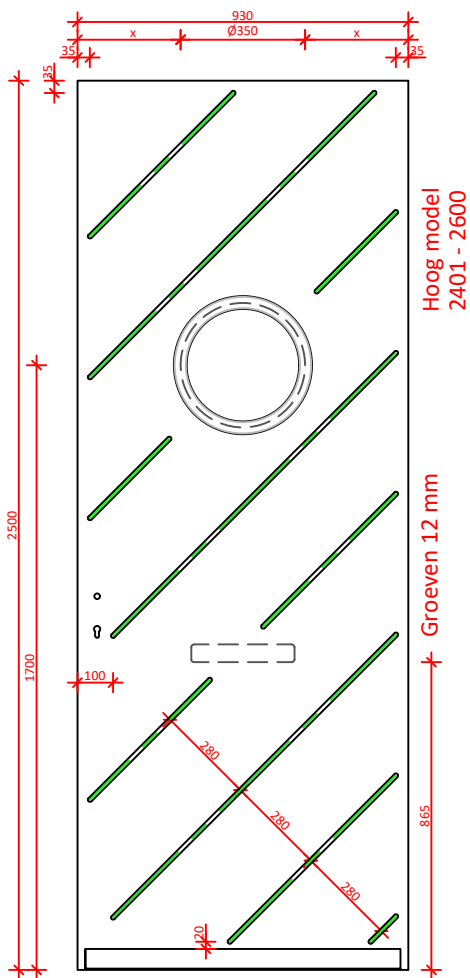
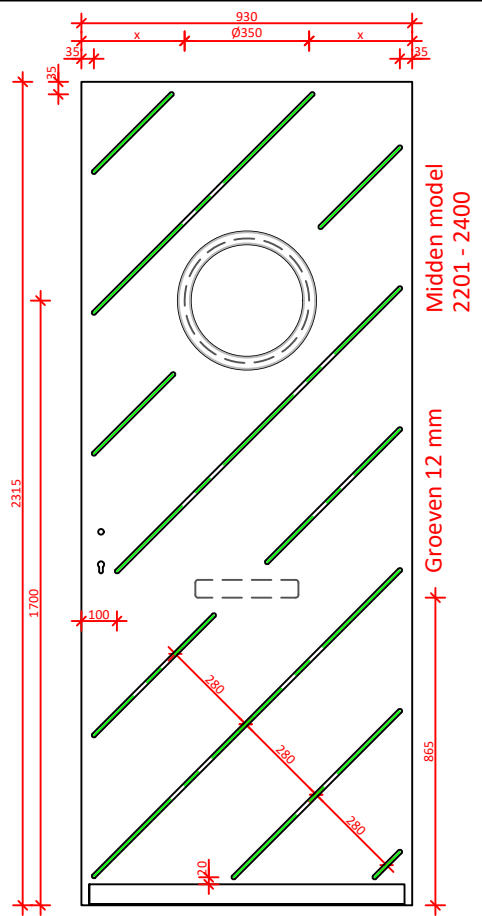
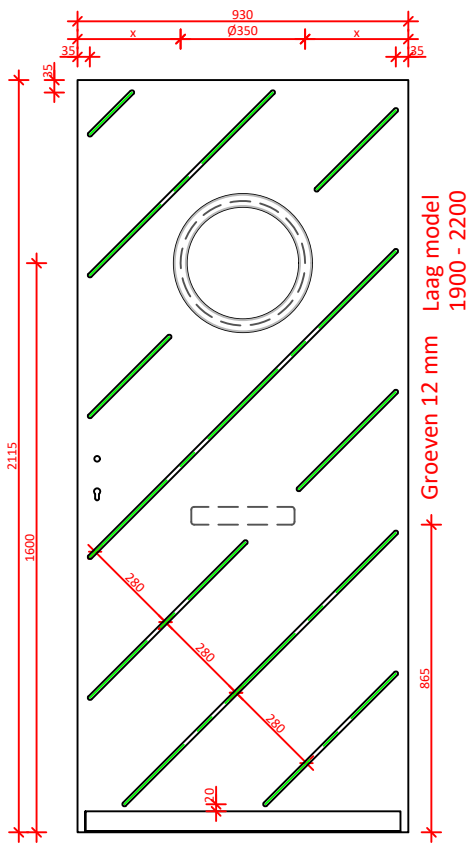

DATUM:	GEWIJZIGD:	CALCULATIENR:	TEKENINGNR: 9835N	MODEL:	HOUTSOORT:
--------	------------	---------------	----------------------	--------	------------

	KLANT/PROJECT: overzicht modellen 9835N met briefleuf			DCM NUMMER:
--	--	--	--	-------------

AANVRAAG:	SCHAAL:	GETEKEND:	LEVERWEEK:	1.2a P.95
-----------	---------	-----------	------------	-----------

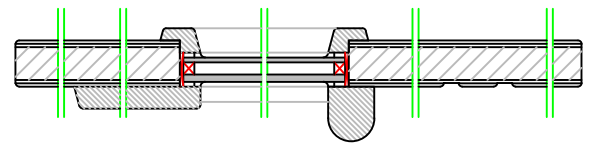
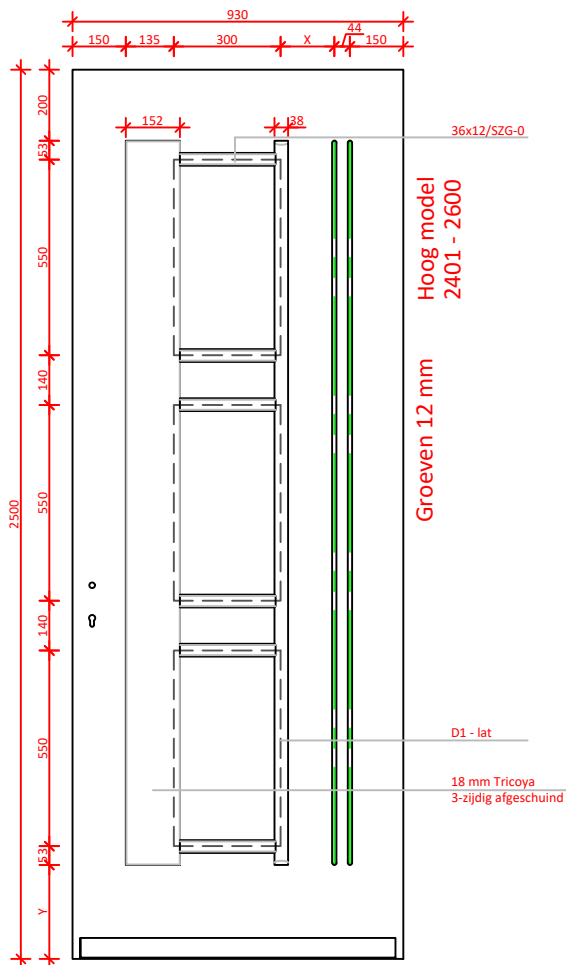
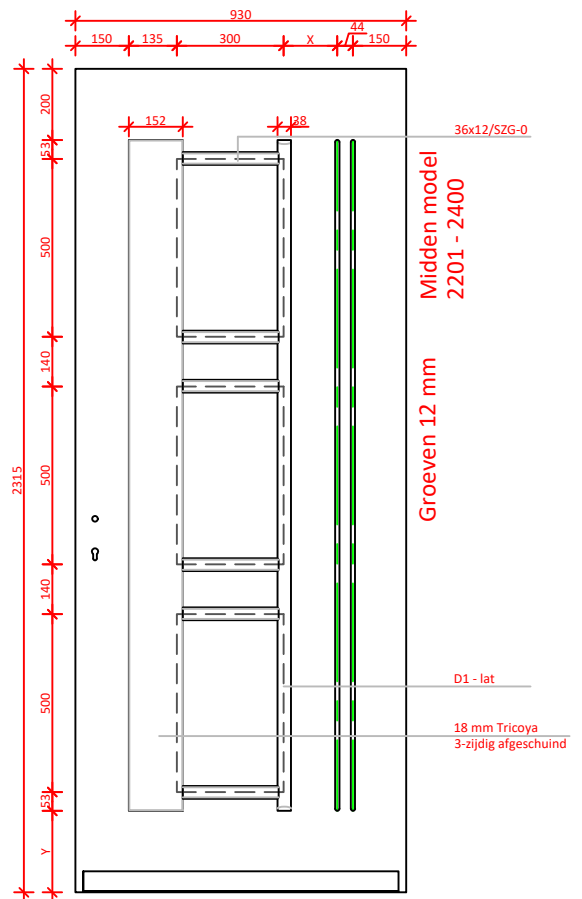
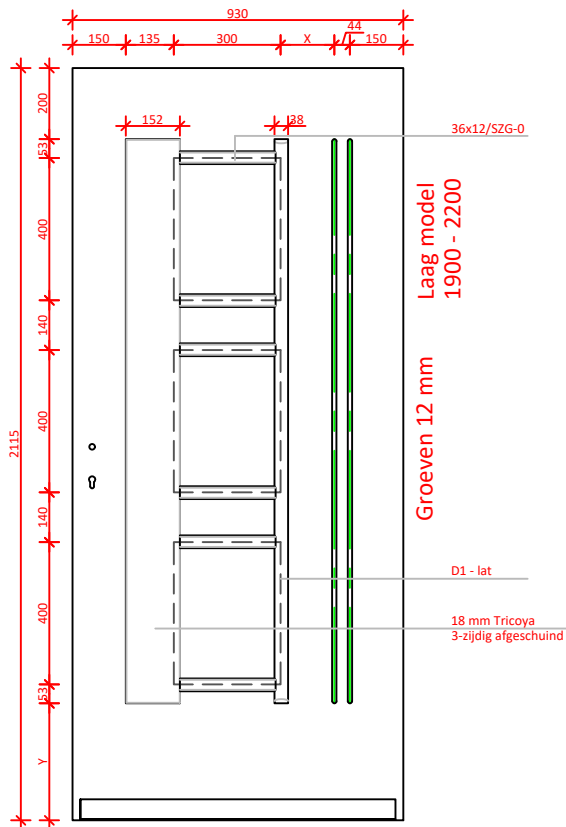

DATUM:	GEWIJZIGD:	CALCULATIENR:	TEKENINGNR:	MODEL: 9843N	HOUTSOORT:
--------	------------	---------------	-------------	-----------------	------------

	KLANT/PROJECT: overzicht modellen 9843N L1 - R4			DCM NUMMER:
--	--	--	--	-------------

AANVRAAG:	SCHAAL:	GETEKEND: MN	LEVERWEEK: 1.2a P.96
-----------	---------	-----------------	-------------------------

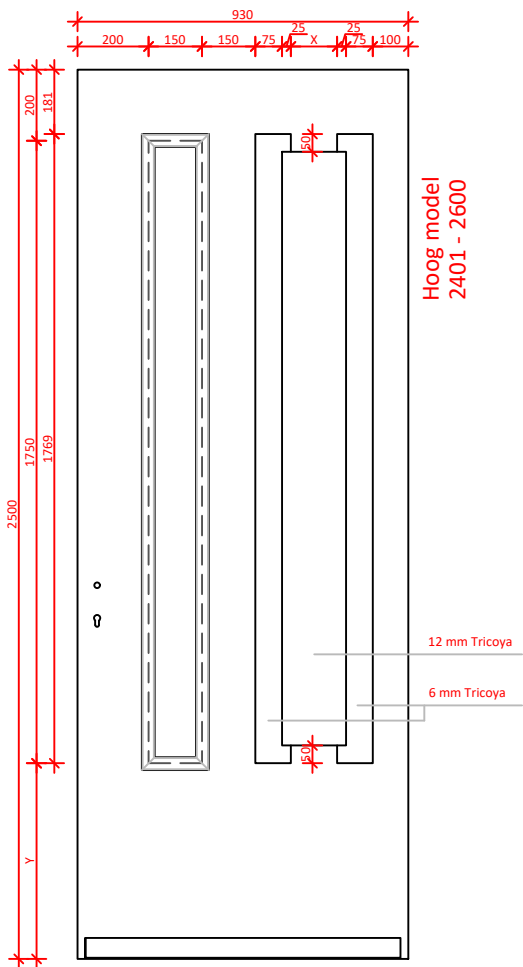
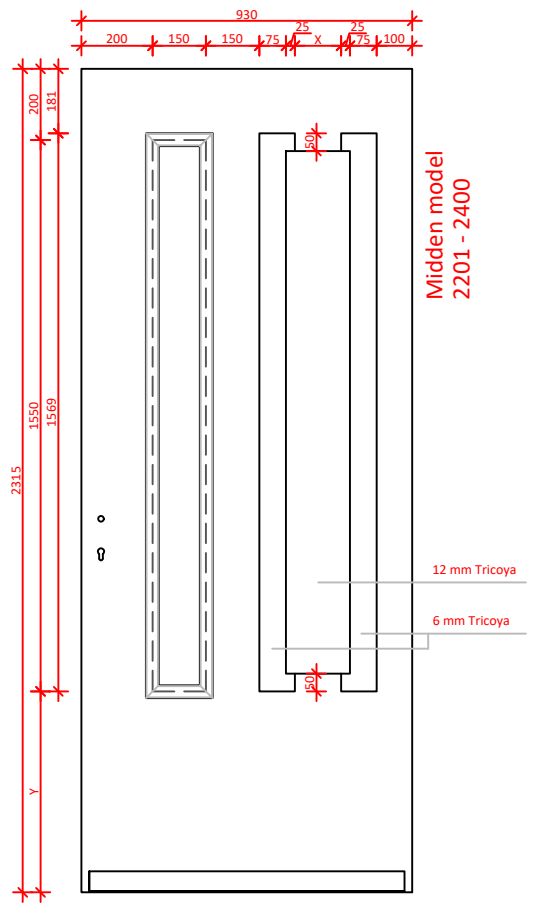
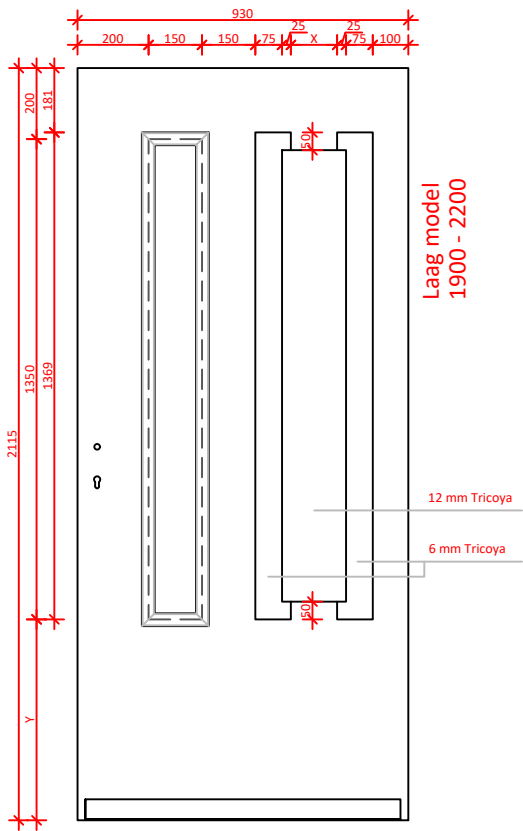

DATUM:	GEWIJZIGD:	CALCULATIENR:	TEKENINGNR:	MODEL: 9844N	HOUTSOORT:
--------	------------	---------------	-------------	-----------------	------------

	KLANT/PROJECT: overzicht modellen 9844N L1 - R4			DCM NUMMER:
--	--	--	--	-------------

AANVRAAG:	SCHAAL:	GETEKEND: MN	LEVERWEEK: 1.2a P.97
-----------	---------	-----------------	-------------------------

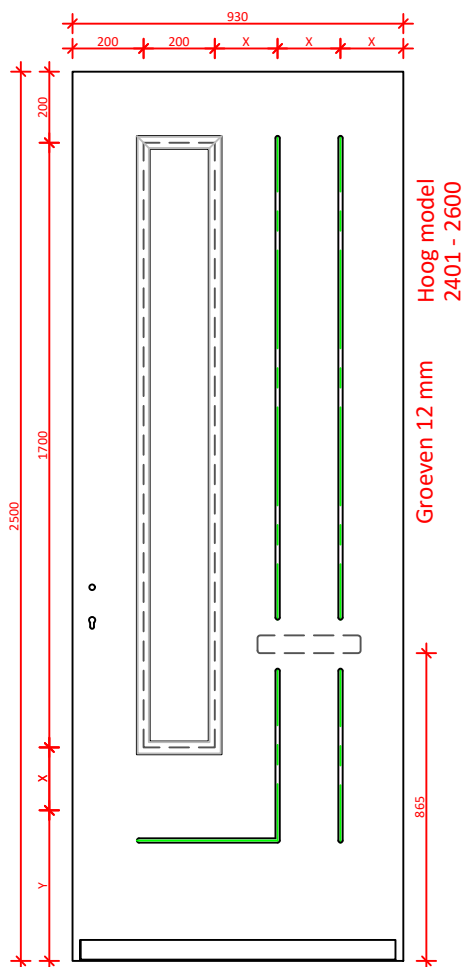
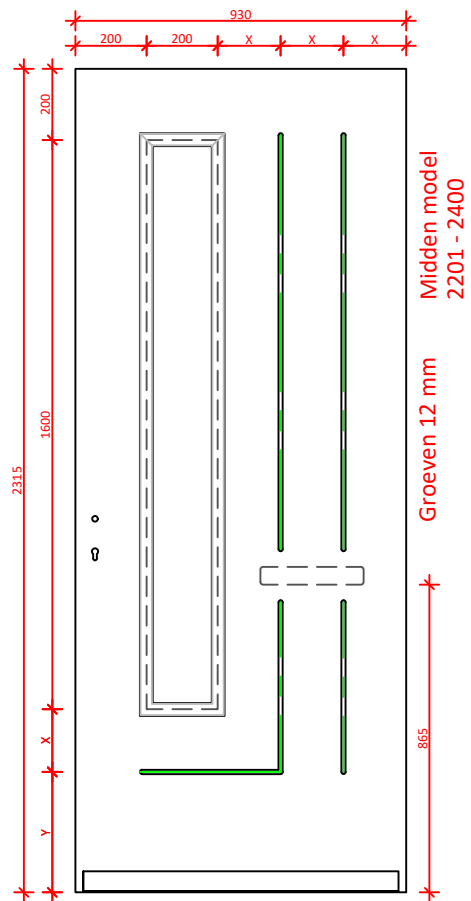
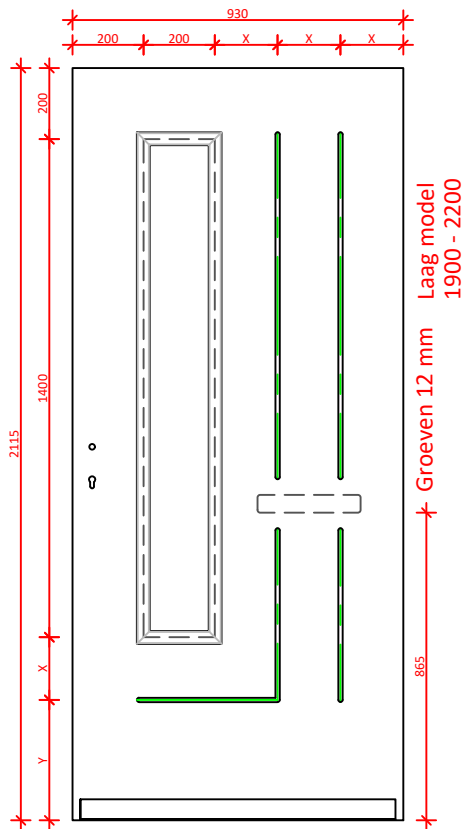

DATUM:	GEWIJZIGD:	CALCULATIENR:	TEKENINGNR:	MODEL: 9846N	HOUTSOORT:
--------	------------	---------------	-------------	-----------------	------------

	KLANT/PROJECT: overzicht modellen 9846N met briefsleuf			DCM NUMMER:
--	---	--	--	-------------

AANVRAAG:	SCHAAL:	GETEKEND: MN	LEVERWEEK:	1.2a P.98
-----------	---------	-----------------	------------	-----------

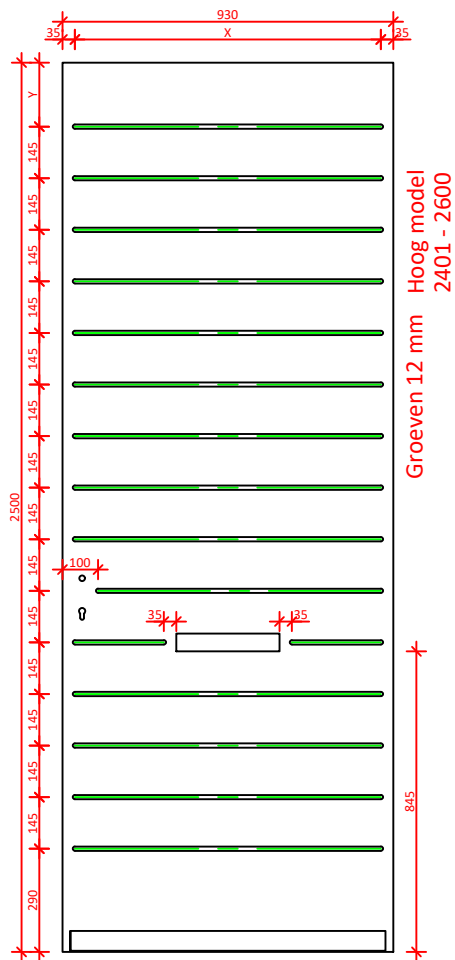
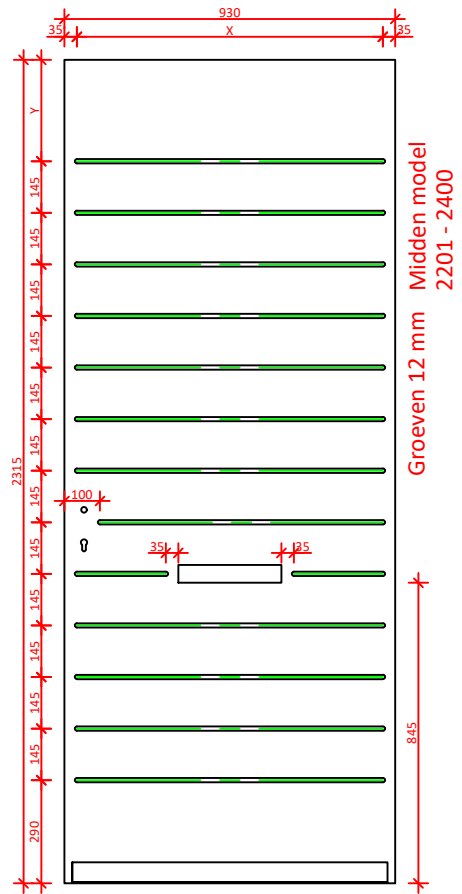
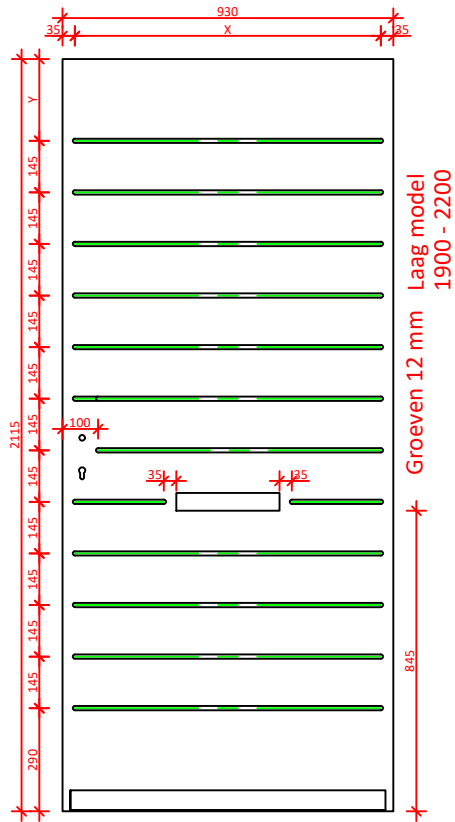

Rekening houden met slothoogte bij senioren schild

DATUM:	GEWIJZIGD:	CALCULATIENR:	TEKENINGNR:	MODEL: 9847N	HOUTSOORT:
--------	------------	---------------	-------------	-----------------	------------

	KLANT/PROJECT: overzicht modellen 9847N briefsleuf			DCM NUMMER:
--	---	--	--	-------------

AANVRAAG:	SCHAAL:	GETEKEND: MN	LEVERWEEK:	1.2a P.99
-----------	---------	-----------------	------------	-----------

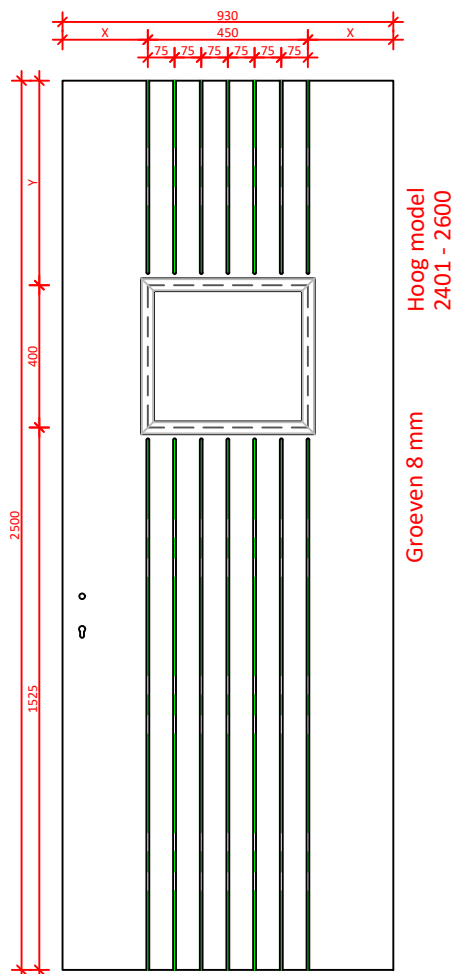
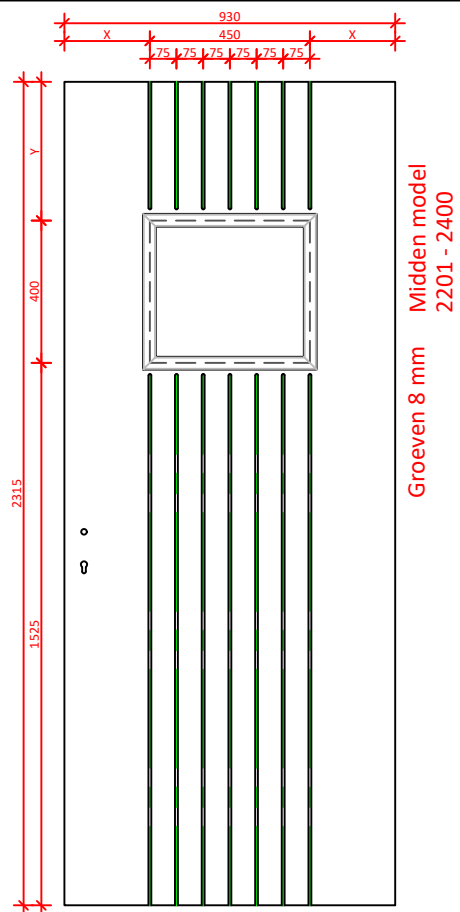
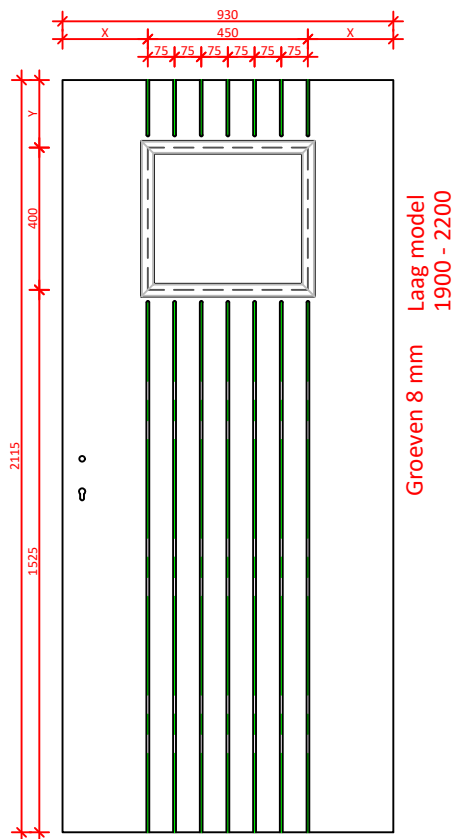

DATUM:	GEWIJZIGD:	CALCULATIENR:	TEKENINGNR:	MODEL: 9848N	HOUTSOORT:
--------	------------	---------------	-------------	-----------------	------------

	KLANT/PROJECT: overzicht modellen 9848N briefsleuf			DCM NUMMER:
--	---	--	--	-------------

AANVRAAG:	SCHAAL:	GETEKEND: MN	LEVERWEEK: 1.2a P.100
-----------	---------	-----------------	--------------------------

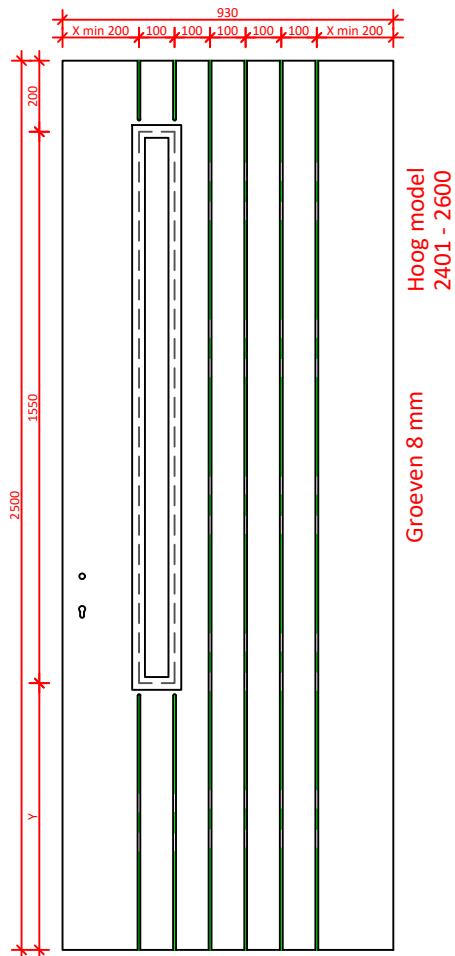
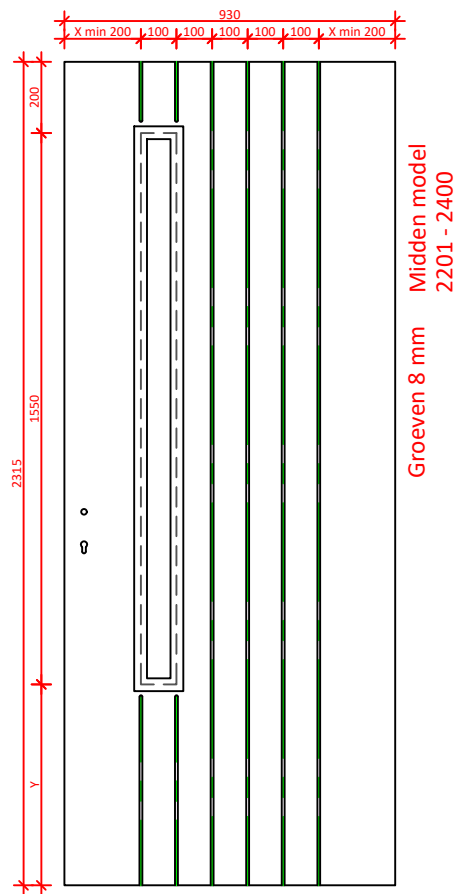
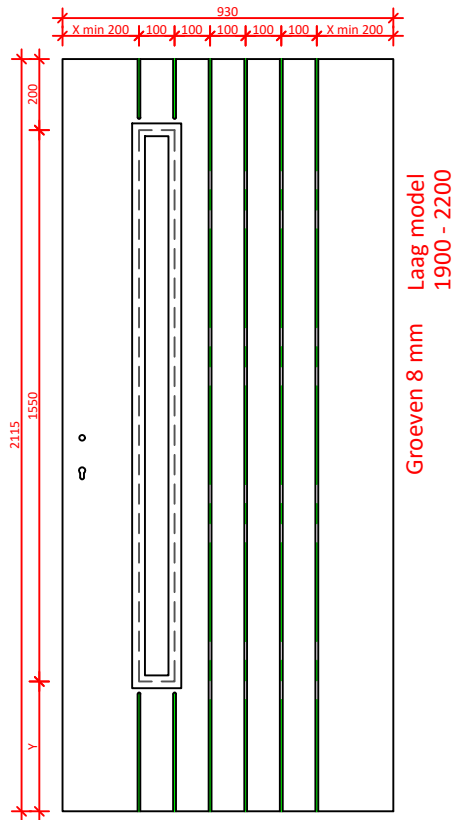

DATUM:	GEWIJZIGD:	CALCULATIENR:	TEKENINGNR:	MODEL: 9849N	HOUTSOORT:
--------	------------	---------------	-------------	-----------------	------------

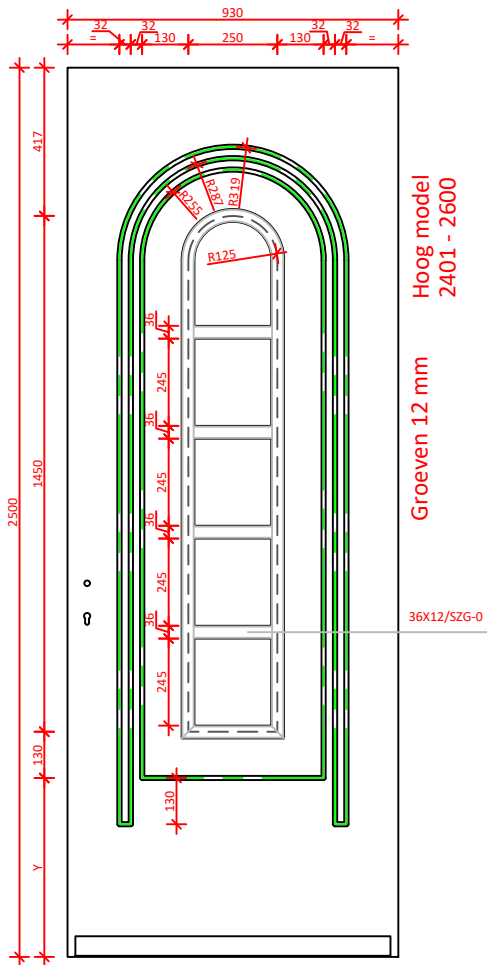
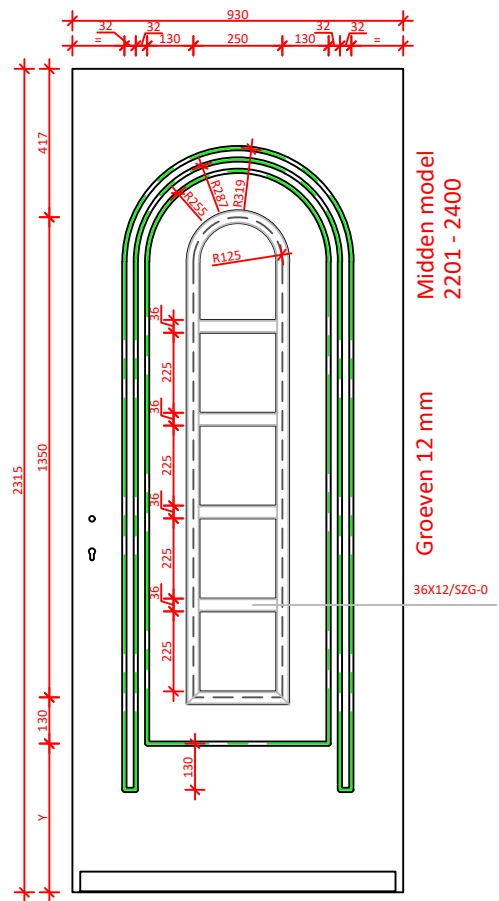
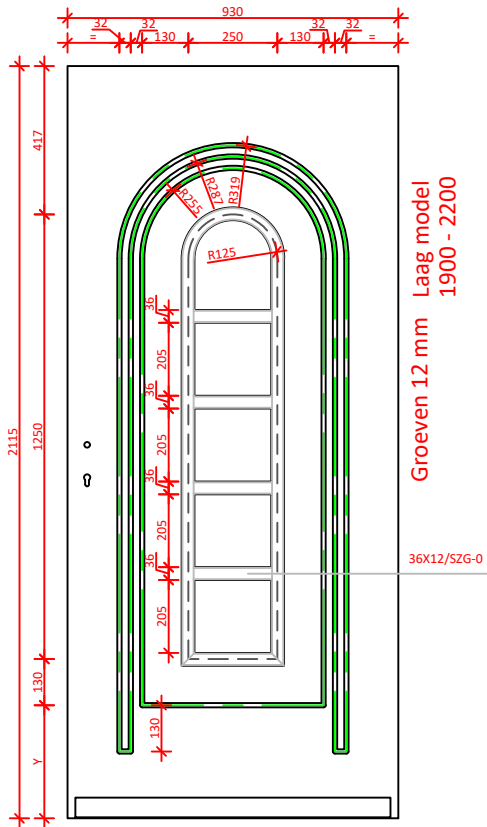

DATUM:	GEWIJZIGD:	CALCULATIENR:	TEKENINGNR: 9860N	MODEL: 9860N	HOUTSOORT:
--------	------------	---------------	----------------------	-----------------	------------

	KLANT/PROJECT: overzicht modellen 9860N briefsleuf			DCM NUMMER:
--	---	--	--	-------------

AANVRAAG:	SCHAAL:	GETEKEND: MN	LEVERWEEK: 1.2a P.102
-----------	---------	-----------------	--------------------------

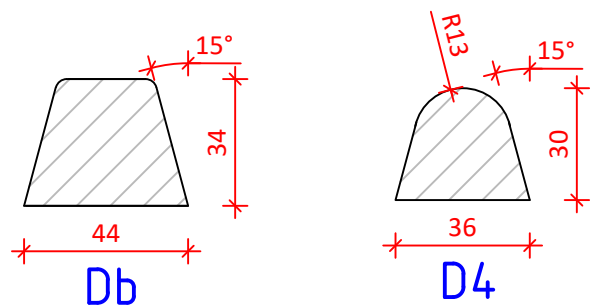
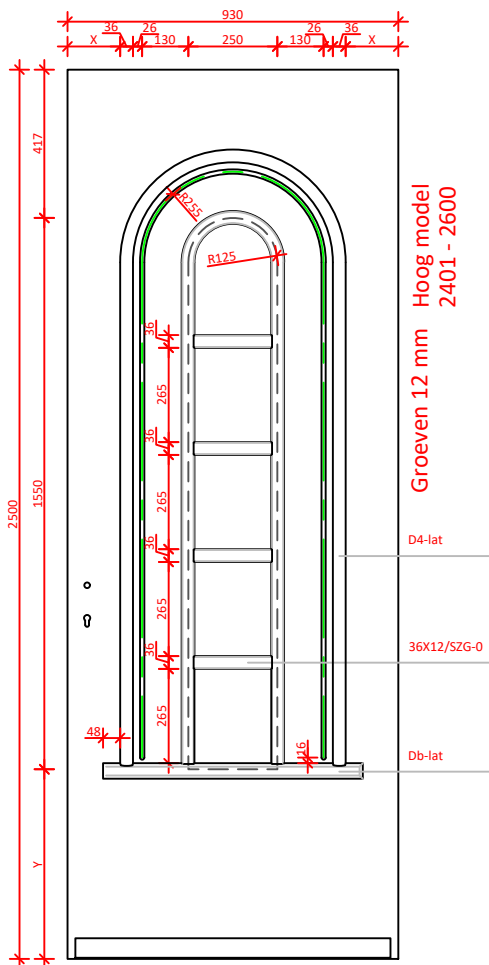
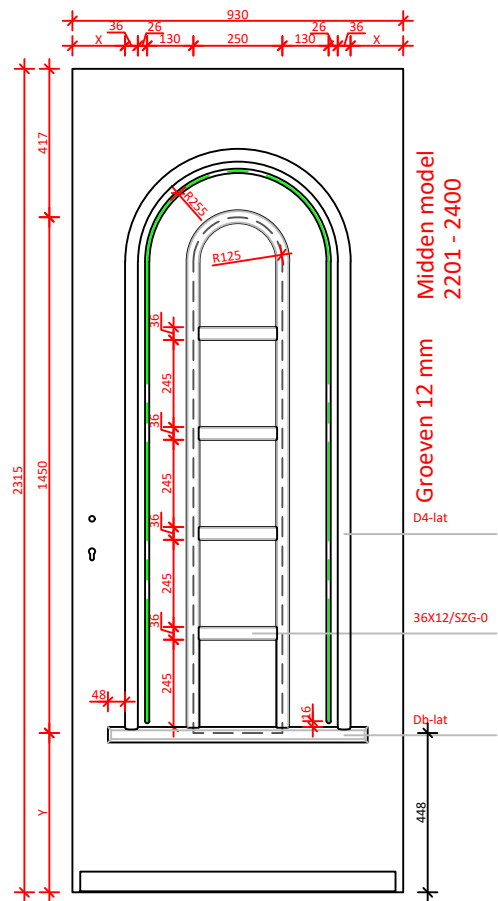
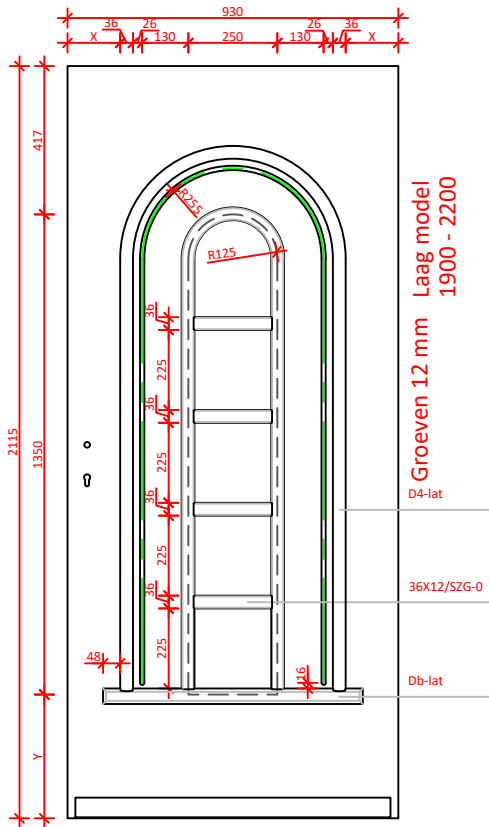

DATUM:	GEWIJZIGD:	CALCULATIENR:	TEKENINGNR:	MODEL: 9861N	HOUTSOORT:
--------	------------	---------------	-------------	-----------------	------------

KEGRO DEUREN	KLANT/PROJECT: overzicht modellen 9861N			DCM NUMMER:	
-----------------------	--	--	--	-------------	--

AANVRAAG:	SCHAAL:	GETEKEND: MN	LEVERWEEK:	1.2a P.103
-----------	---------	-----------------	------------	------------

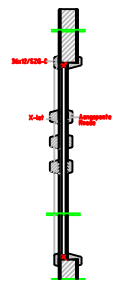
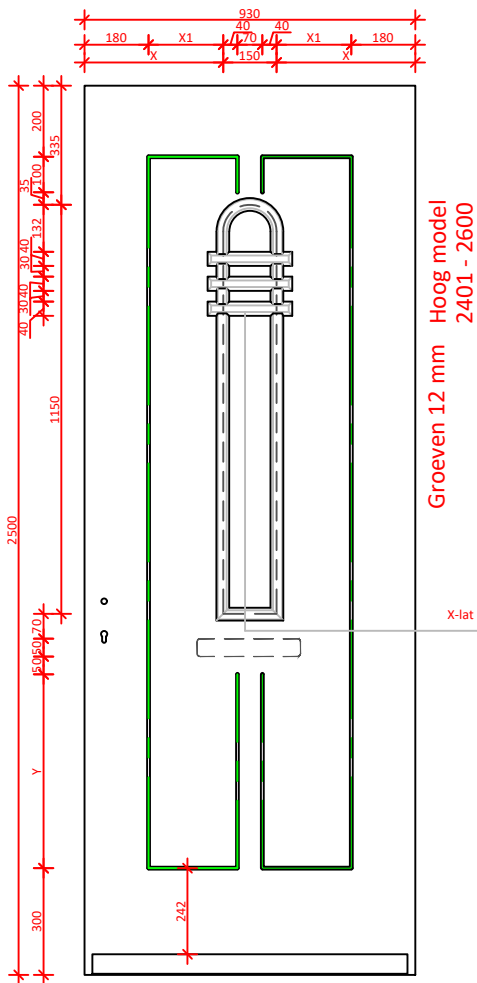
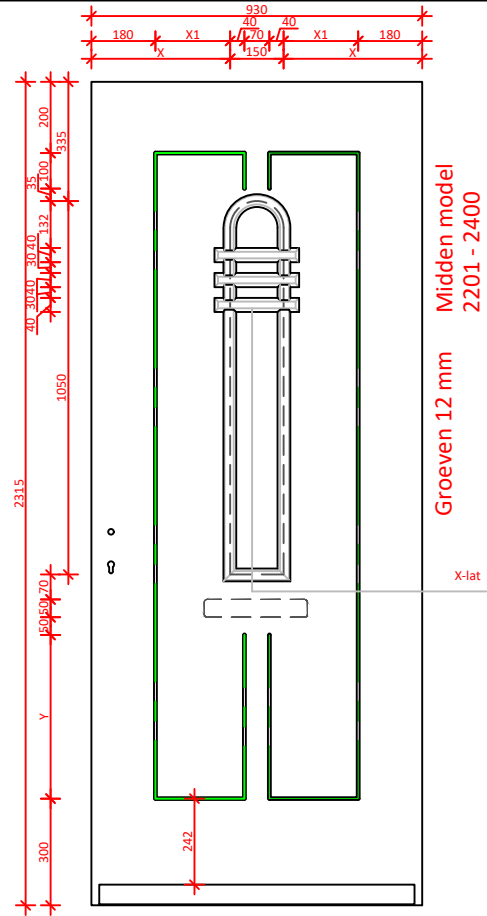
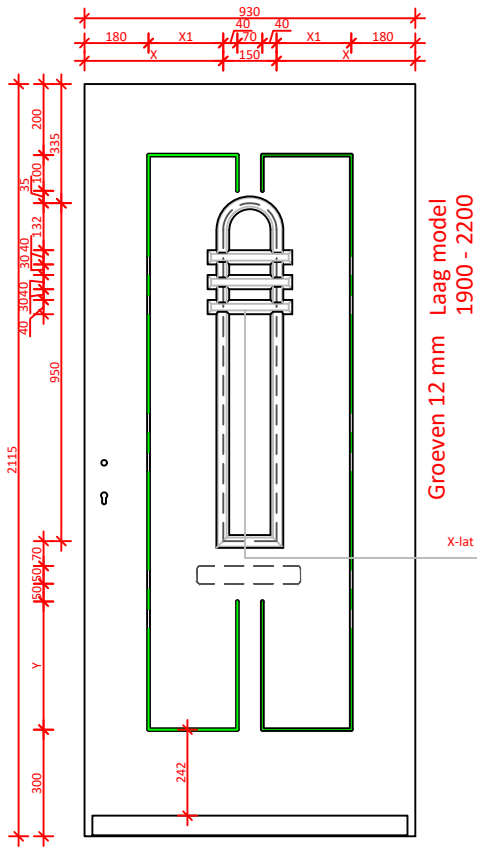

DATUM:	GEWIJZIGD:	CALCULATIENR:	TEKENINGNR:	MODEL: 9862N	HOUTSOORT:
--------	------------	---------------	-------------	-----------------	------------

	KLANT/PROJECT: overzicht modellen 9862N briefsleuf			DCM NUMMER:
--	---	--	--	-------------

AANVRAAG:	SCHAAL:	GETEKEND: MN	LEVERWEEK: 1.2a P.104
-----------	---------	-----------------	--------------------------

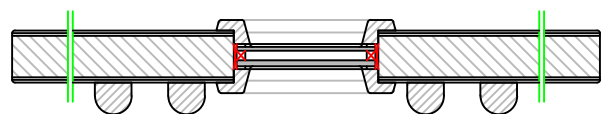
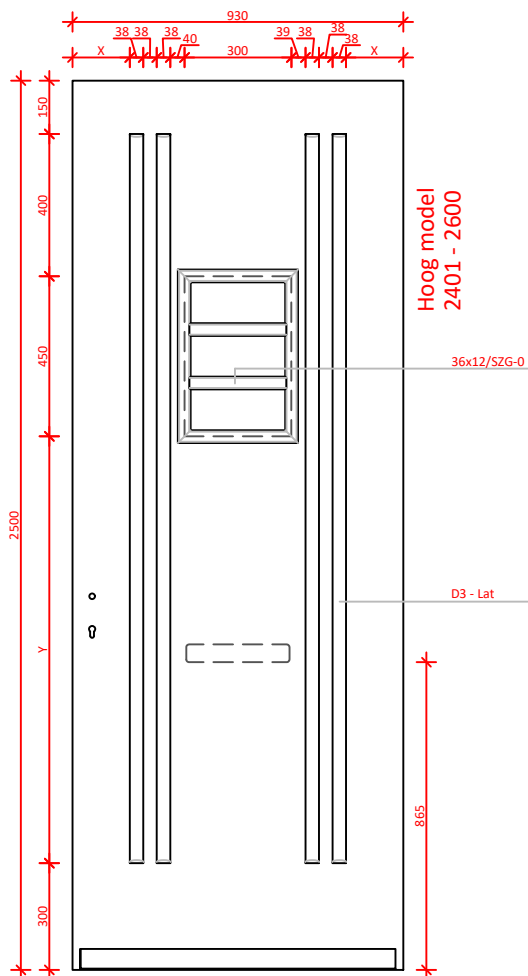
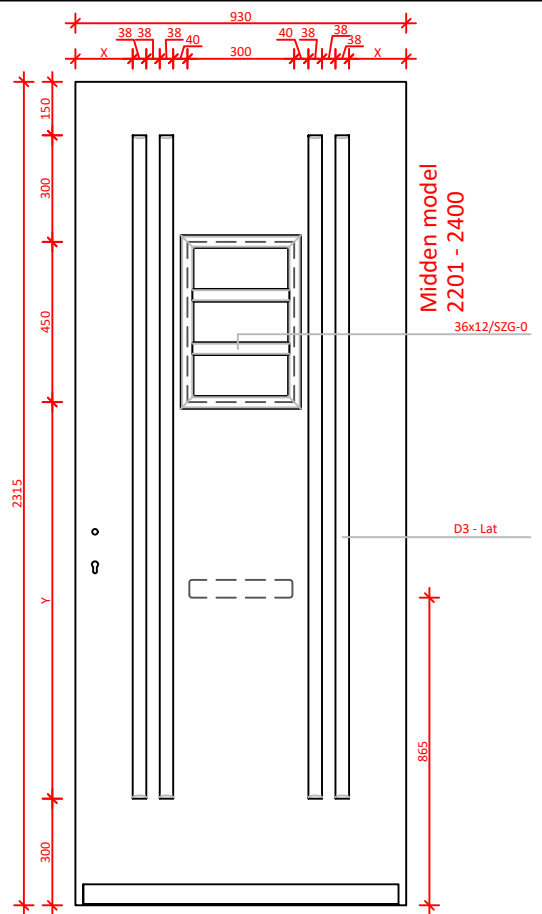
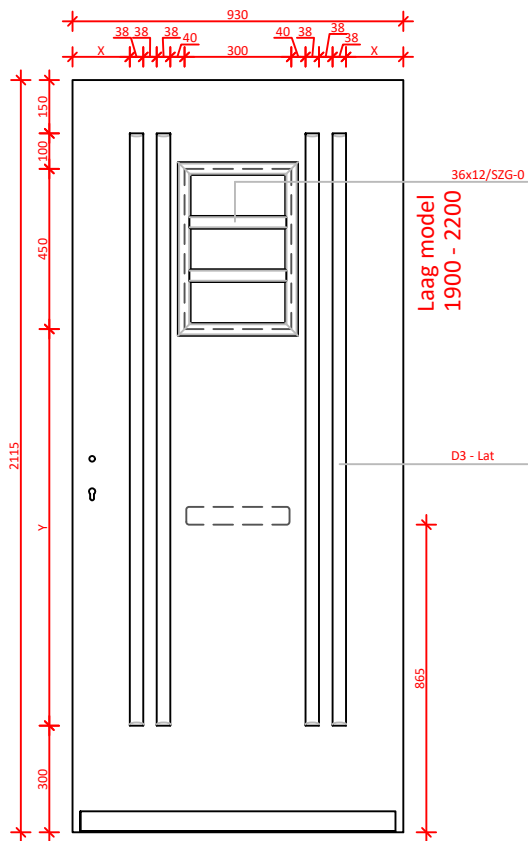

DATUM:	GEWIJZIGD:	CALCULATIENR:	TEKENINGNR:	MODEL: 9863N	HOUTSOORT:
--------	------------	---------------	-------------	-----------------	------------

	KLANT/PROJECT: overzicht modellen 9863N			DCM NUMMER:
--	--	--	--	-------------

AANVRAAG:	SCHAAL:	GETEKEND: MN	LEVERWEEK:	1.2a P.105
-----------	---------	-----------------	------------	------------

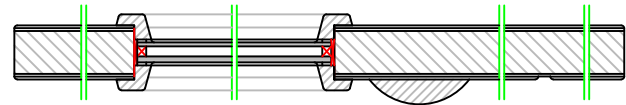
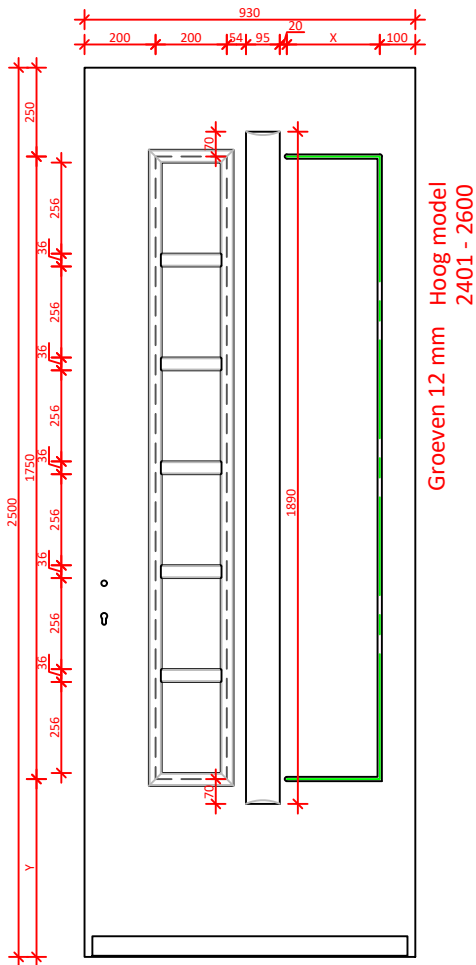
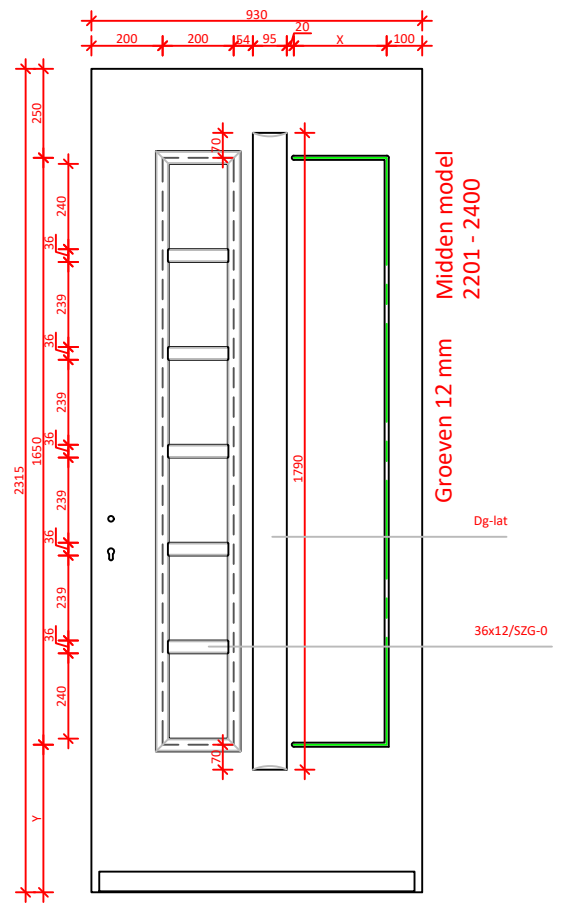
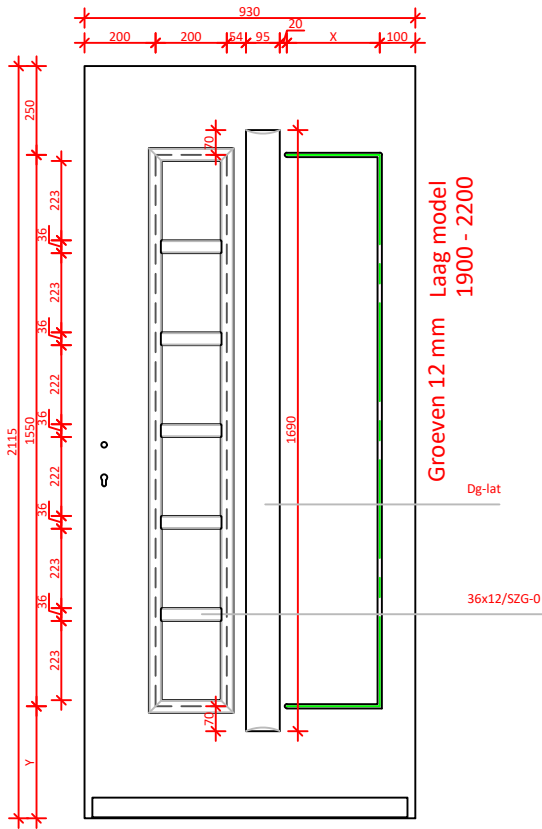

DATUM:	GEWIJZIGD:	CALCULATIENR:	TEKENINGNR:	MODEL: 9864N	HOUTSOORT:
--------	------------	---------------	-------------	-----------------	------------

KEGRO DEUREN	KLANT/PROJECT: overzicht modellen 9864N			DCM NUMMER:
-----------------------	--	--	--	-------------

AANVRAAG:	SCHAAL:	GETEKEND: MN	LEVERWEEK: 1.2a P.106
-----------	---------	-----------------	--------------------------

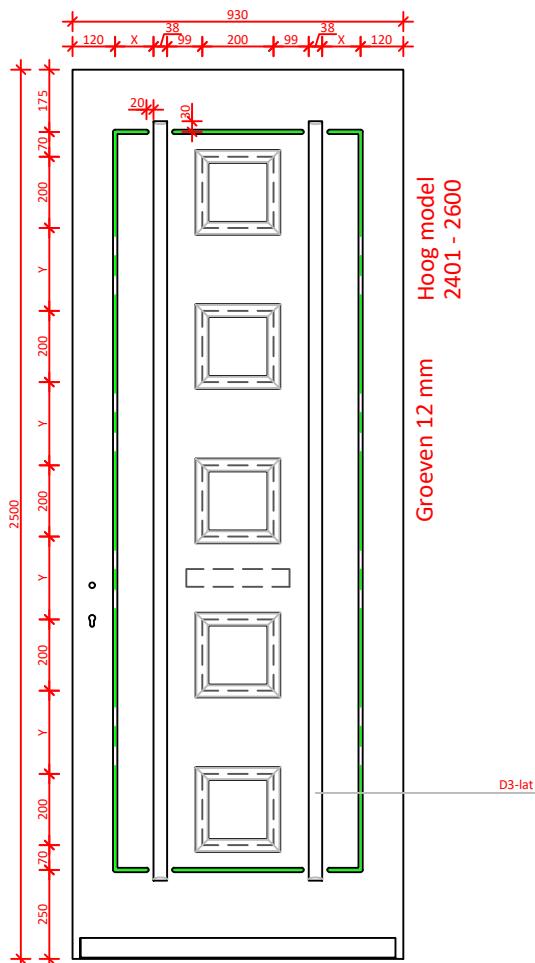
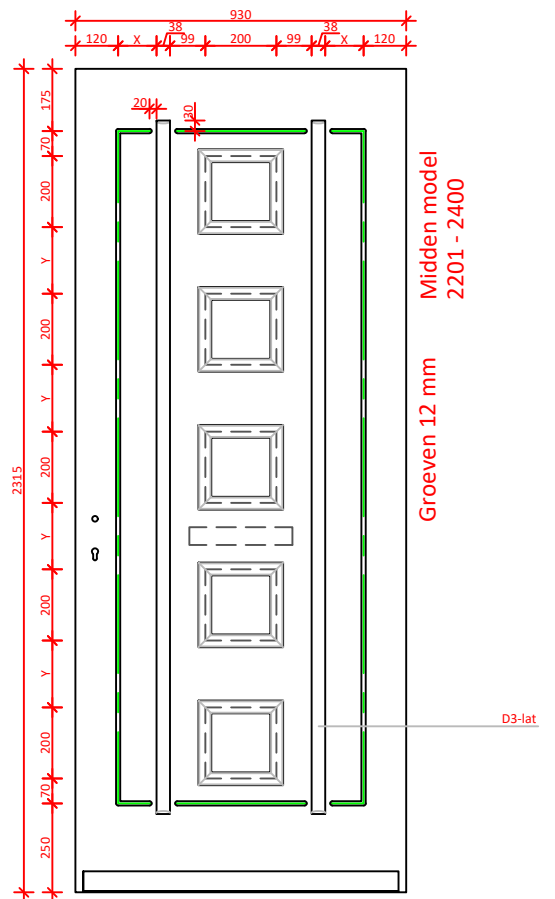
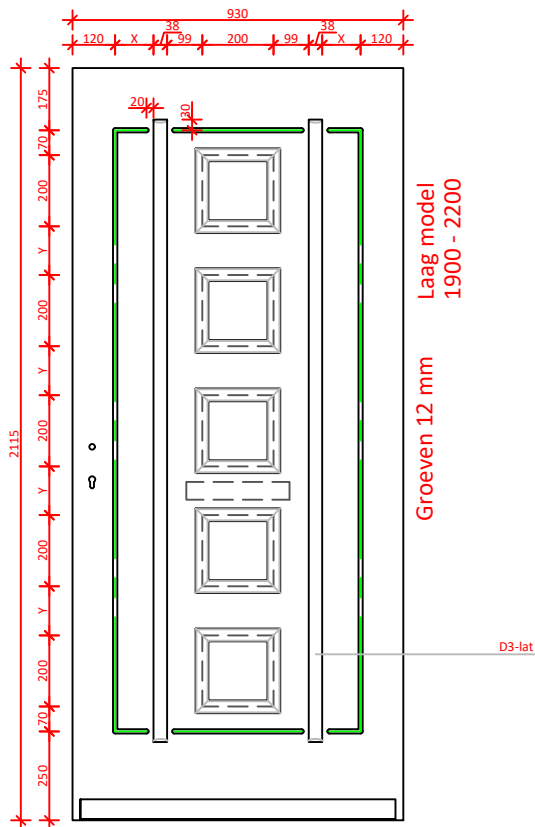

DATUM:	GEWIJZIGD:	CALCULATIENR:	TEKENINGNR:	MODEL: 9865N	HOUTSOORT:
--------	------------	---------------	-------------	-----------------	------------

	KLANT/PROJECT: overzicht modellen 9865N			DCM NUMMER:
--	--	--	--	-------------

AANVRAAG:	SCHAAL:	GETEKEND: MN	LEVERWEEK: 1.2a P.107
-----------	---------	-----------------	--------------------------

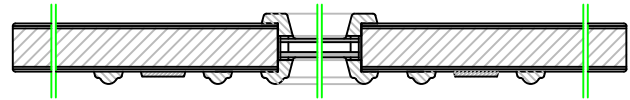
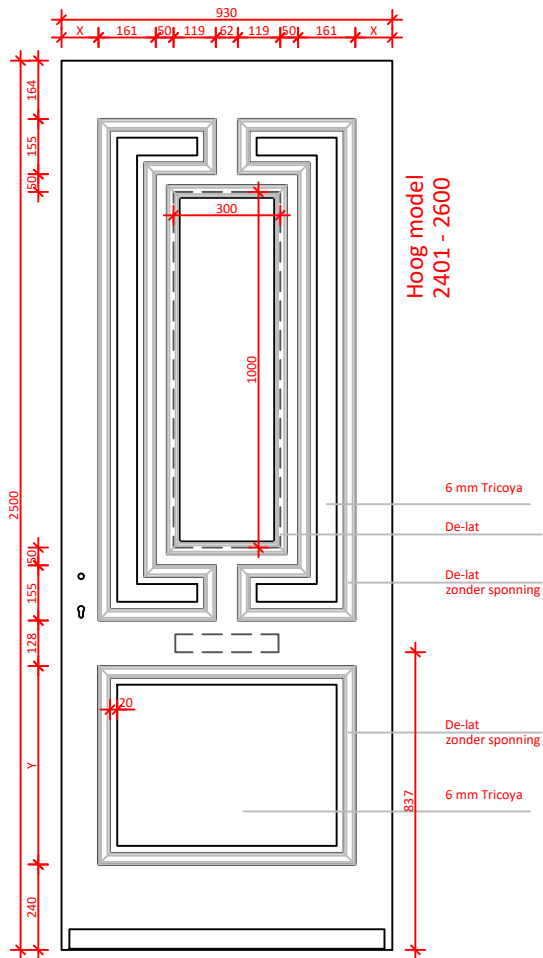
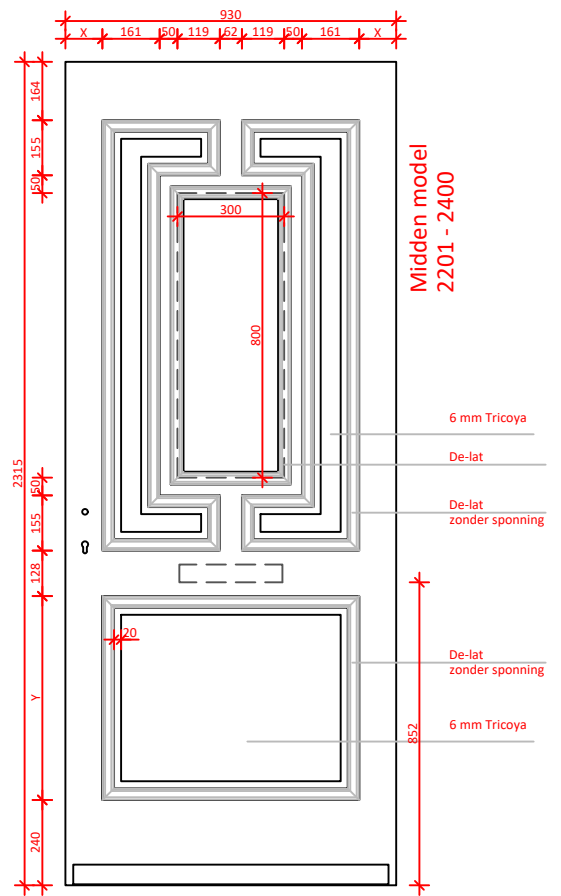
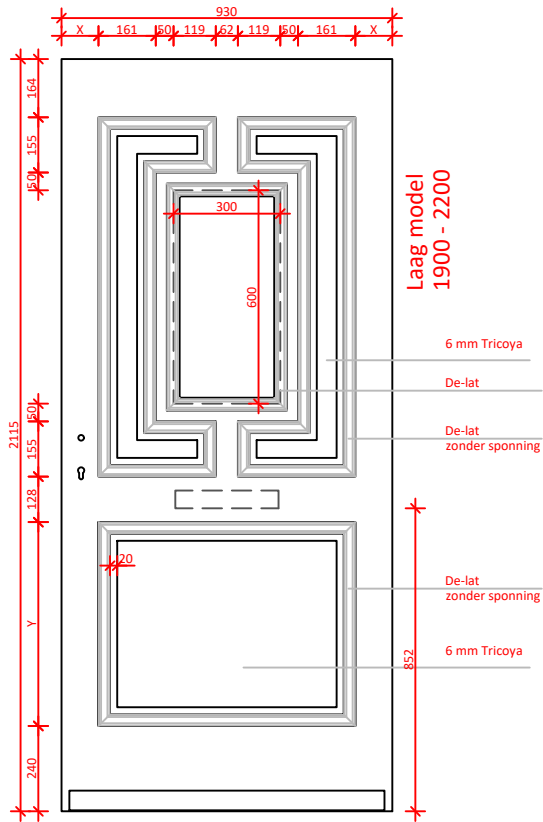

DATUM:	GEWIJZIGD:	CALCULATIENR:	TEKENINGNR: 9866N	MODEL: 9866N	HOUTSOORT:
--------	------------	---------------	----------------------	-----------------	------------

KEGRO DEUREN	KLANT/PROJECT: overzicht modellen 9866N			DCM NUMMER:
-----------------------	--	--	--	-------------

AANVRAAG:	SCHAAL:	GETEKEND: MN	LEVERWEEK: 1.2a P.108
-----------	---------	-----------------	--------------------------

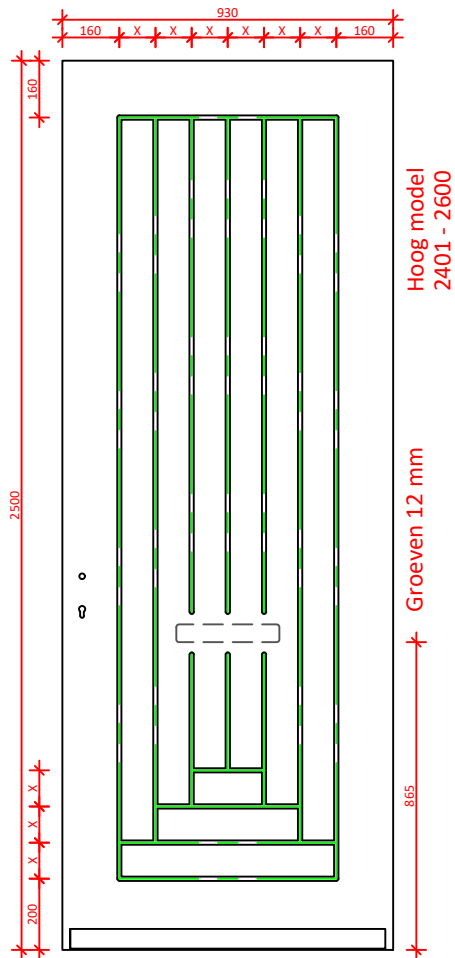
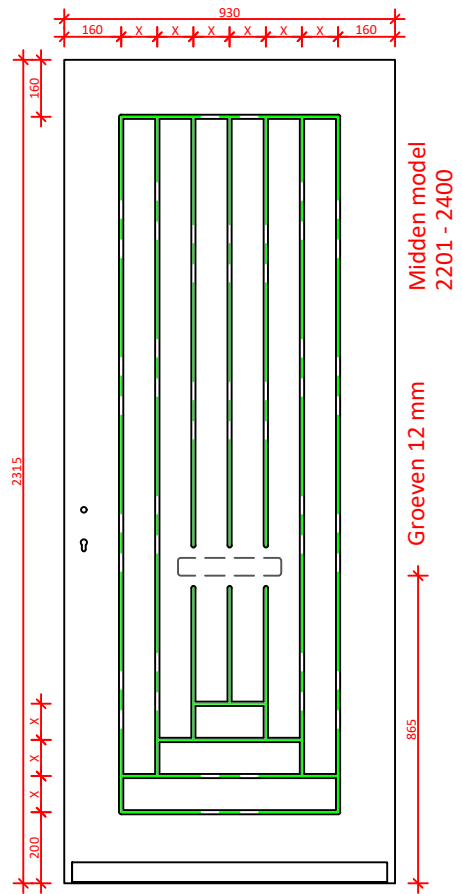
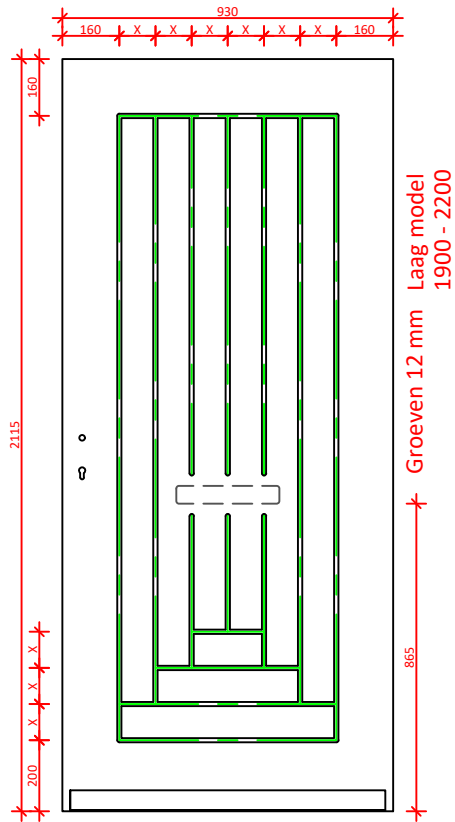

DATUM:	GEWIJZIGD:	CALCULATIENR:	TEKENINGNR:	MODEL: 9867	HOUTSOORT:
--------	------------	---------------	-------------	----------------	------------

	KLANT/PROJECT: overzicht modellen 9867 met briefsleuf			DCM NUMMER:
--	--	--	--	-------------

AANVRAAG:	SCHAAL:	GETEKEND: MN	LEVERWEEK: 1.2a P.109
-----------	---------	-----------------	--------------------------

1.2A Deuropbouw en maatvoering Vlakke Deuren

Overzicht Kegro Architectura deurenlijn

- <2200mm = Laag model
- 2201 – 2400mm = Midden model
- >2401mm = Hoog model

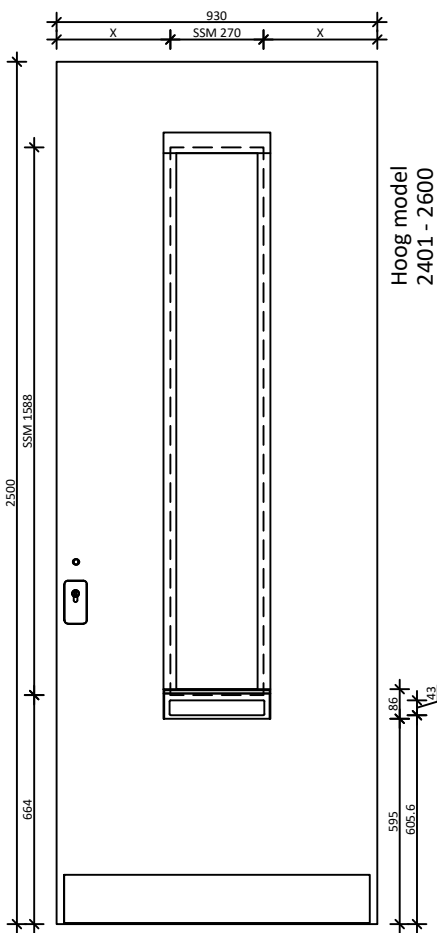
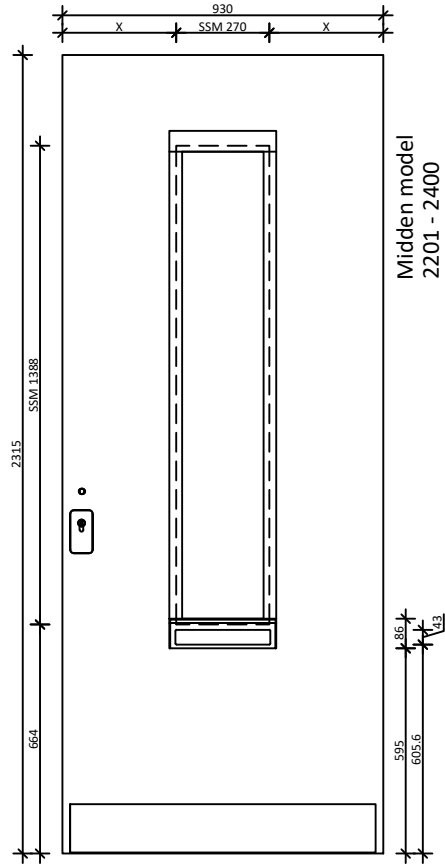
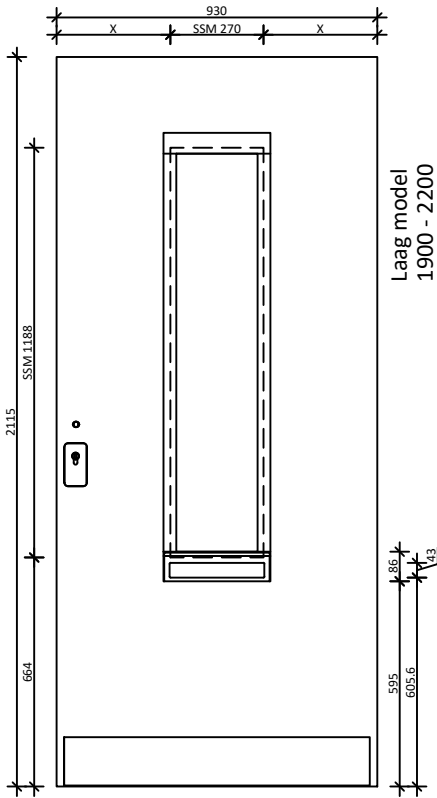

Kruk gat alleen aan binnenzijde, ivm combi rozet (cilinder en deurknop) als standaard

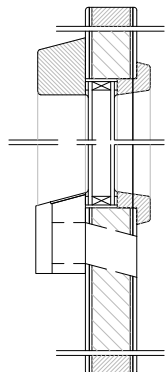
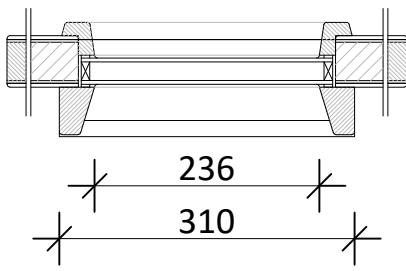

DATUM: 01-02-2024	GEWIJZIGD:	CALCULATIENR:	TEKENINGNR: 20230201-940-01	MODEL: 94001	HOUTSOORT:
			KLANT/PROJECT: Model 94001 Overzicht		DCM NUMMER:
			AANVRAAG:	SCHAAL:	GETEKEND: KF
					1.2a P.111

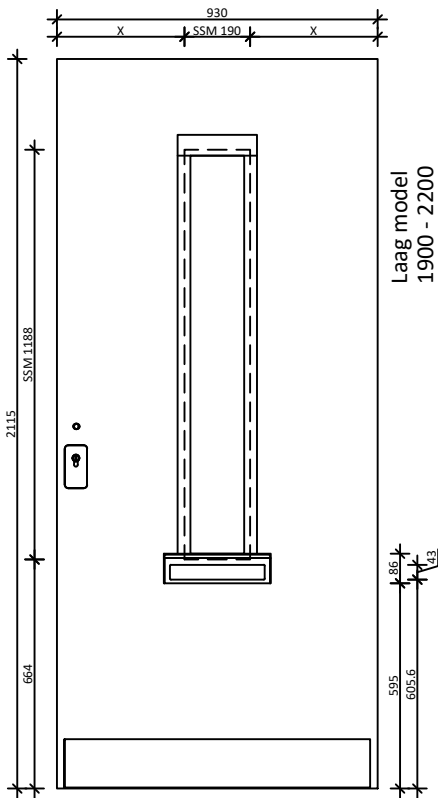

Laag model
1900 - 2200

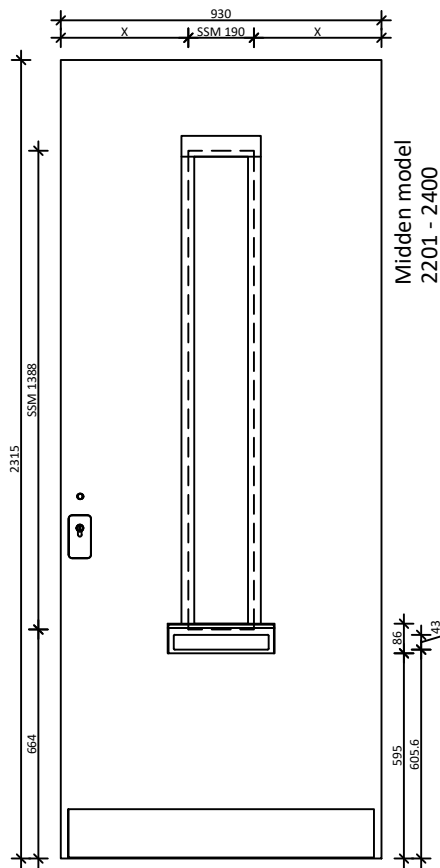

Midden model
2201 - 2400

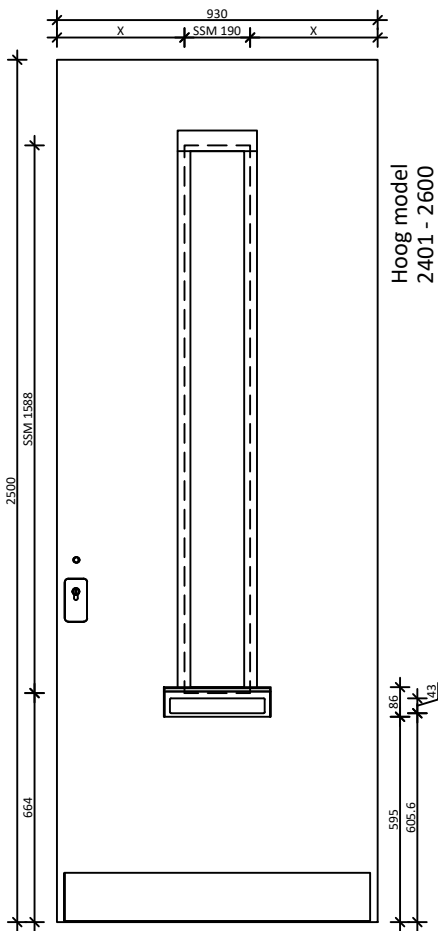

Hoog model
2401 - 2600

Kruk gat alleen aan binnenzijde, ivm combi rozet (cilinder en deurknop) als standaard

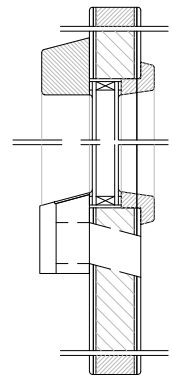
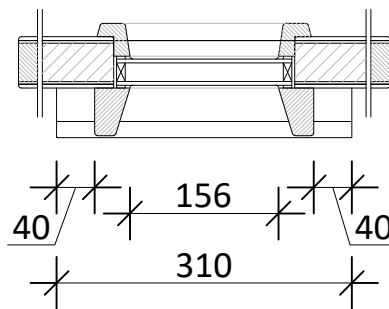

DATUM:
01-02-2024

GEWIJZIGD:

CALCULATIENR:

TEKENINGNR:
20230201-940-01

MODEL:
94002

HOUSOORT:

KEGRO | DEUREN

KLANT/PROJECT:
Model 94002 Overzicht

DCM NUMMER:

AANVRAAG:

SCHAAL:

GETEKEND:
KF

LEVERWEEK:

1.2a P.112

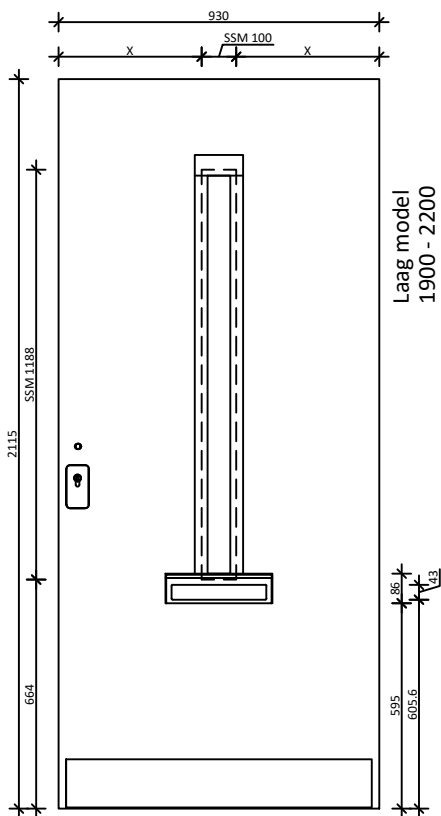

Laag model
1900 - 2200

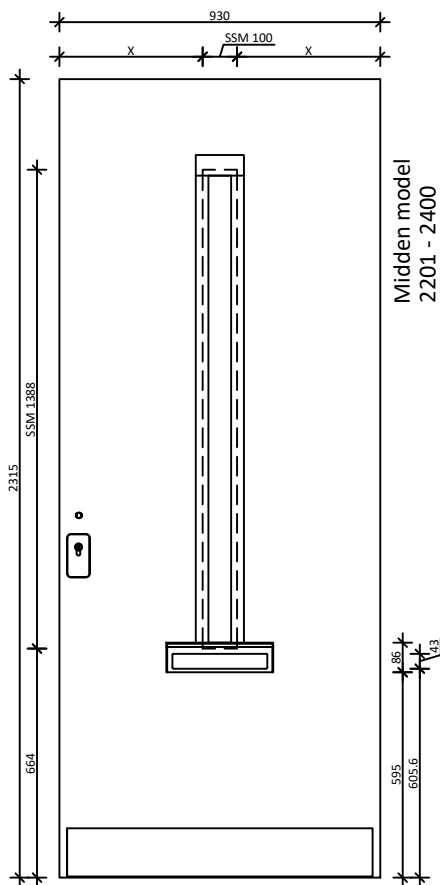

Midden model
2201 - 2400

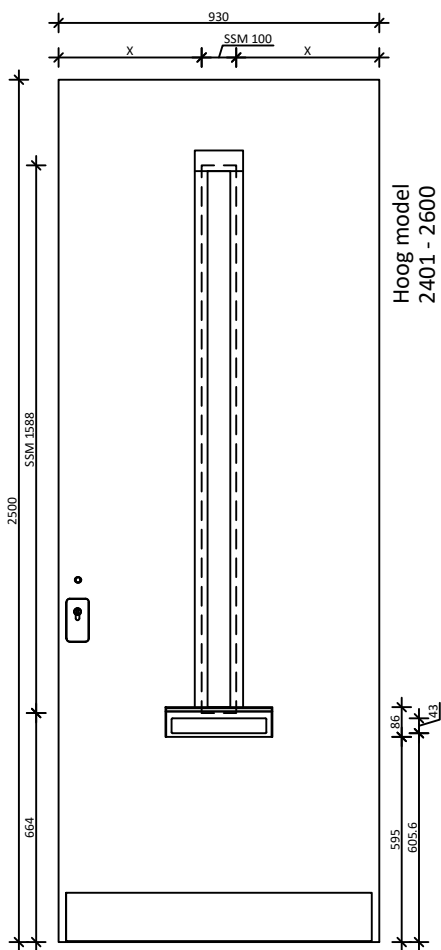

Hoog model
2401 - 2600

Kruk gat alleen aan binnenzijde, ivm combi rozet (cilinder en deurknop) als standaard

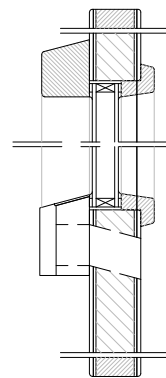
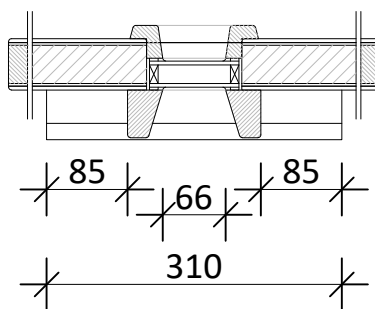

DATUM:
01-02-2024

GEWIJZIGD:

CALCULATIENR:

TEKENINGNR:
20230201-940-01

MODEL:
94003

HOUSOORT:

KEGRO | DEUREN

KLANT/PROJECT:
Model 94003 Overzicht

DCM NUMMER:

AANVRAAG:

SCHAAL:

GETEKEND:
KF

LEVERWEEK:

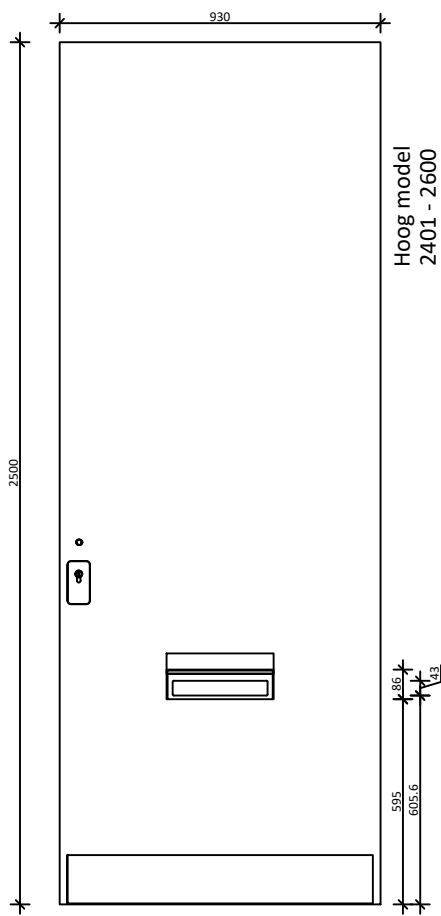
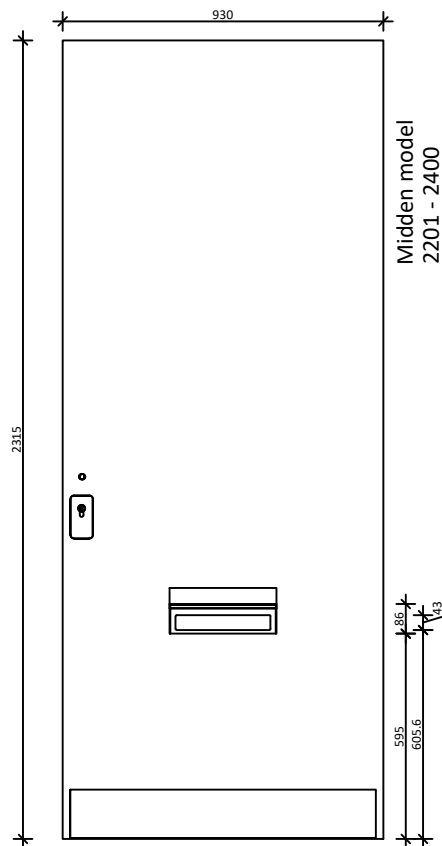
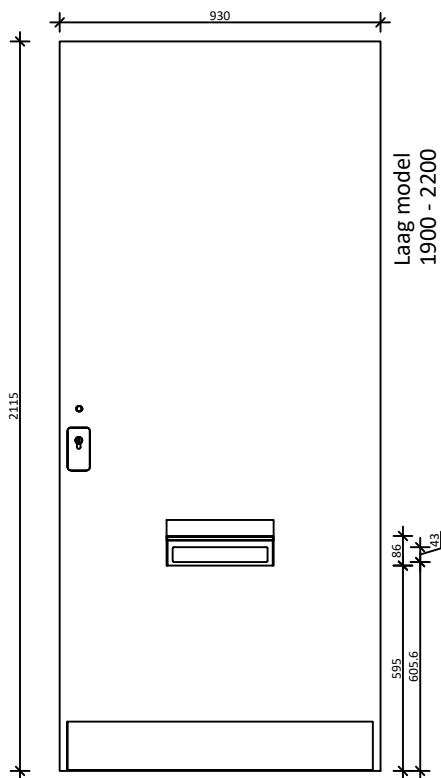

Kruk gat alleen aan binnenzijde, ivm combi rozet (cilinder en deurknop) als standaard

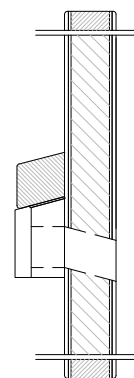

DATUM:
01-02-2024

GEWIJZIGD:

CALCULATIENR:

TEKENINGNR:
20230201-940-01

MODEL:
94004

HOUSOORT:

KEGRO | DEUREN

KLANT/PROJECT:
Model 94004 Overzicht

DCM NUMMER:

AANVRAAG:

SCHAAL:

GETEKEND:
KF

LEVERWEEK:

1.2a P.114

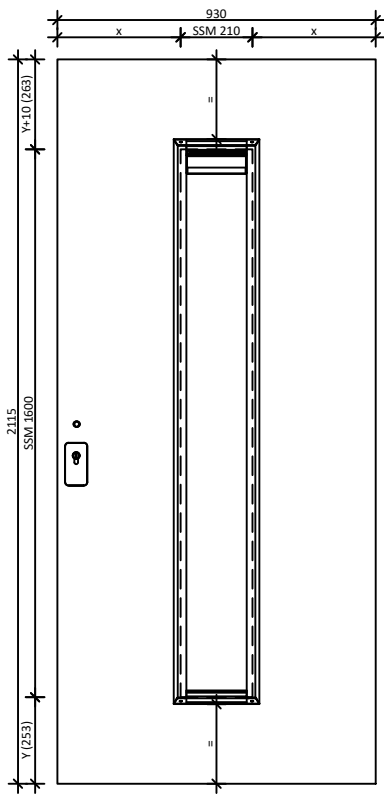

Laag model
1900 - 2200

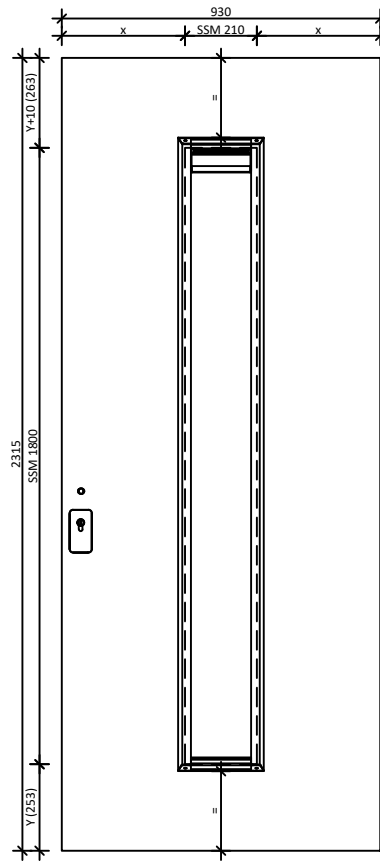

Midden model
2201 - 2400

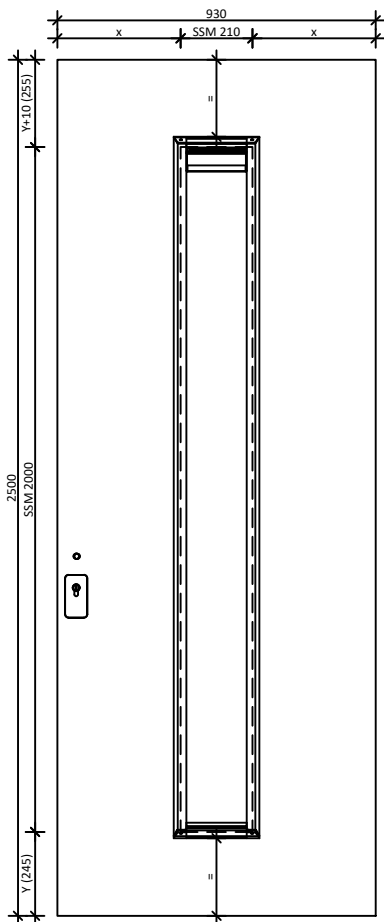

Hoog model
2401 - 2600

Kruk gat alleen aan binnenzijde, ivm combi rozet (cilinder en deurknop) als standaard

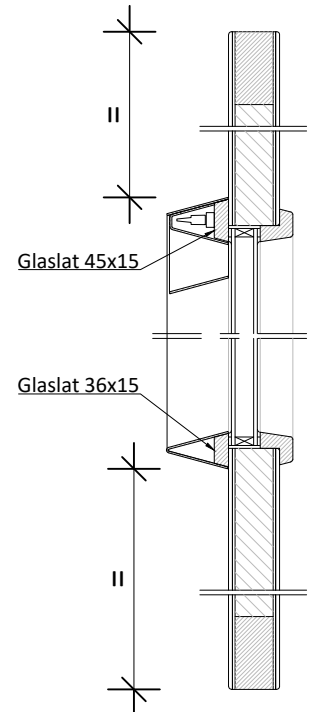
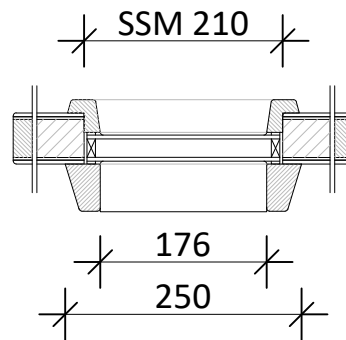

DATUM:
01-02-2024

GEWIJZIGD:

CALCULATIENR:

TEKENINGNR:
20230201-941-01

MODEL:
94101

HOUTSOORT:

KEGRO | DEUREN

KLANT/PROJECT:
Model 94101 Overzicht

DCM NUMMER:

AANVRAAG:

SCHAAL:

GETEKEND:
KF

LEVERWEEK:

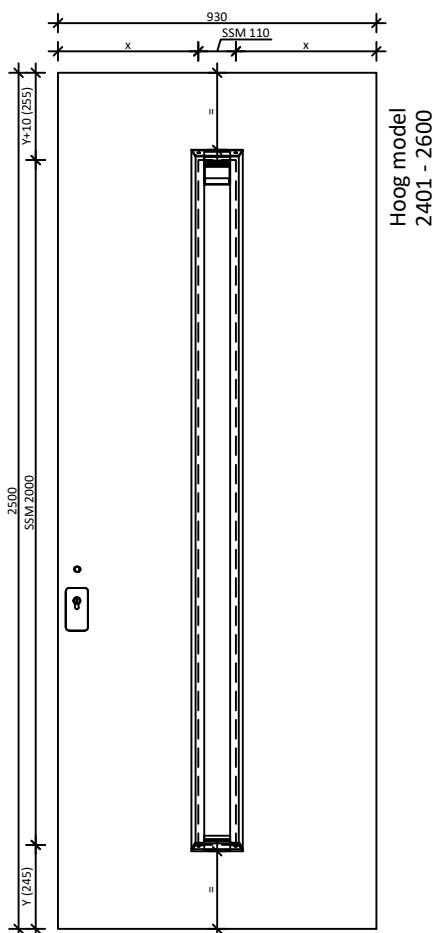
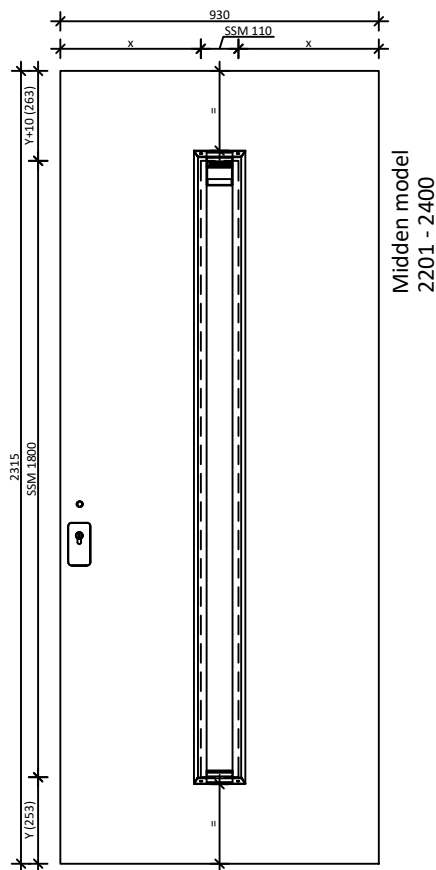
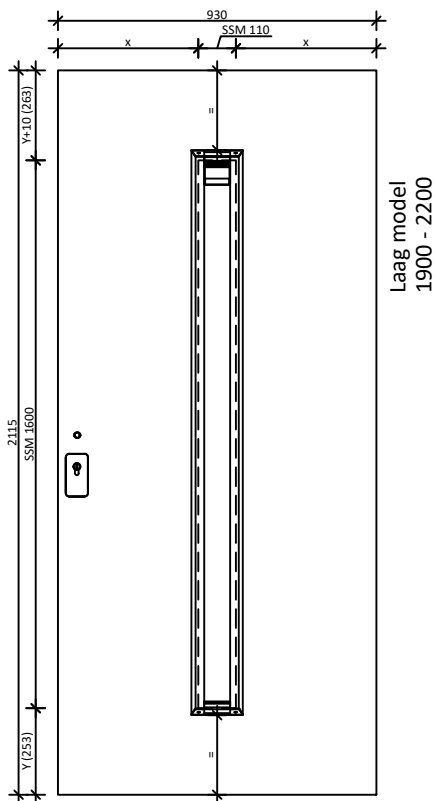

Kruk gat alleen aan binnenzijde, ivm combi rozet (cilinder en deurknop) als standaard

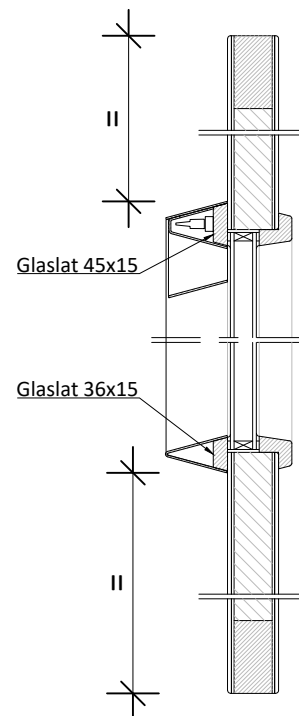
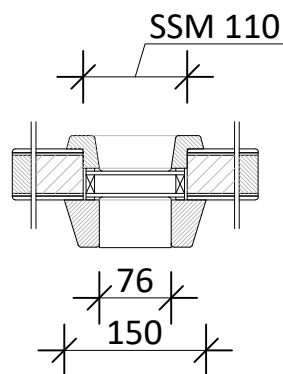

DATUM:
01-02-2024

GEWIJZIGD:

CALCULATIENR:

TEKENINGNR:
20230201-941-01

MODEL:
94102

HOUSOORT:

KEGRO | DEUREN

KLANT/PROJECT:
Model 94102 Overzicht

DCM NUMMER:

AANVRAAG:

SCHAAL:

GETEKEND:
KF

LEVERWEEK:

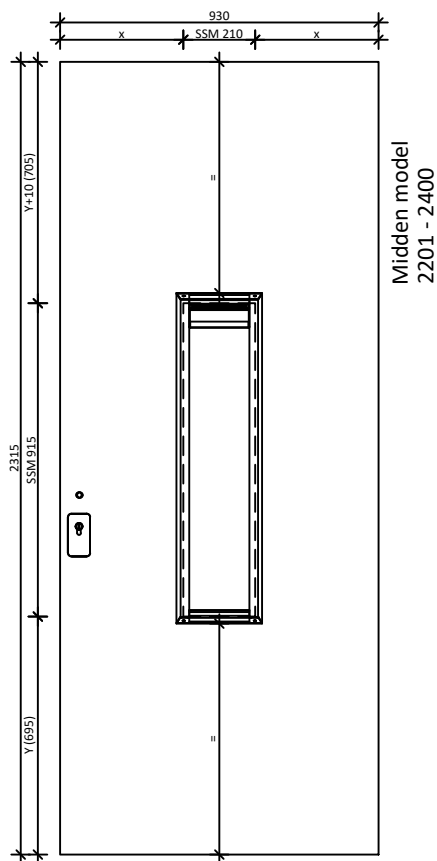
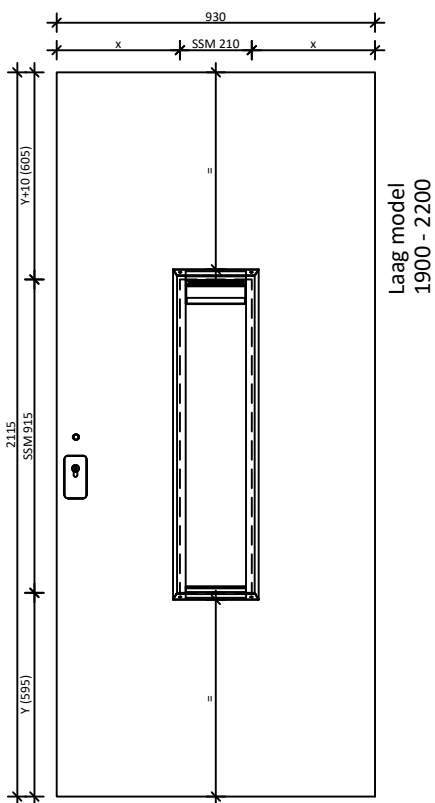

Kruk gat alleen aan binnenzijde, ivm combi rozet (cilinder en deurknop) als standaard

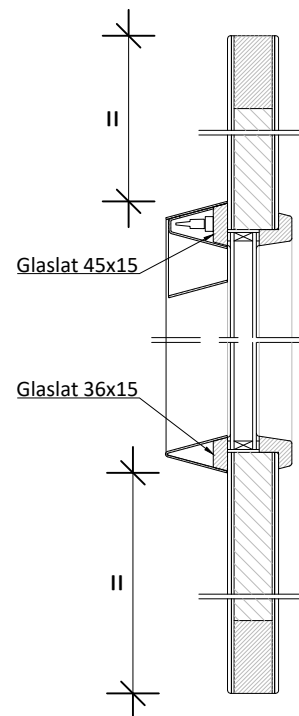
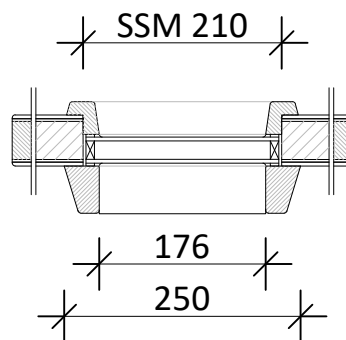
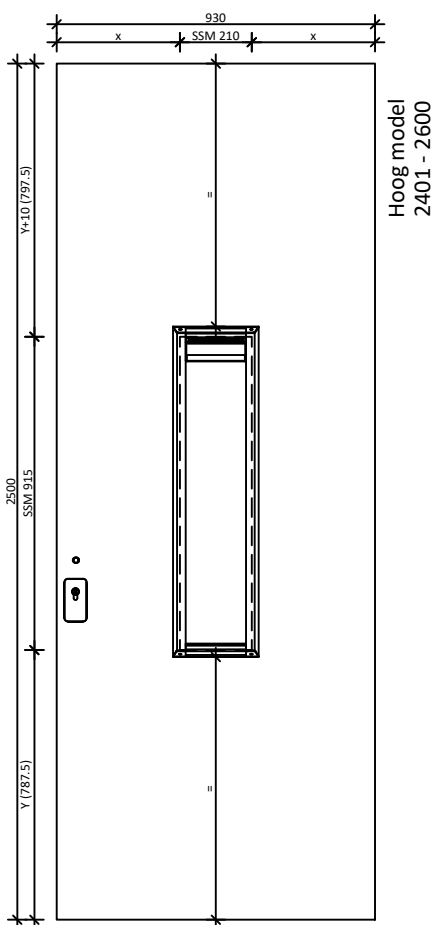

DATUM:
01-02-2024

GEWIJZIGD:

CALCULATIENR:

TEKENINGNR:
20230201-941-01

MODEL:
94103

HOUSOORT:

KEGRO | DEUREN

KLANT/PROJECT:
Model 94103 Overzicht

DCM NUMMER:

AANVRAAG:

SCHAAL:

GETEKEND:
KF

LEVERWEEK:

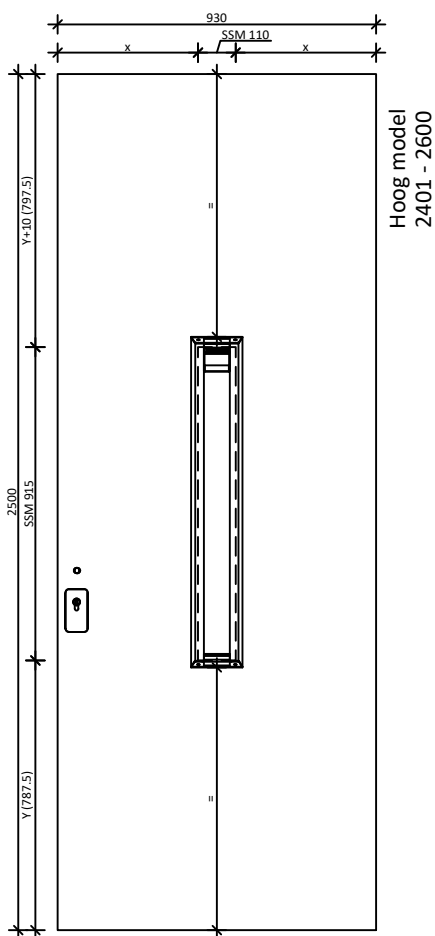
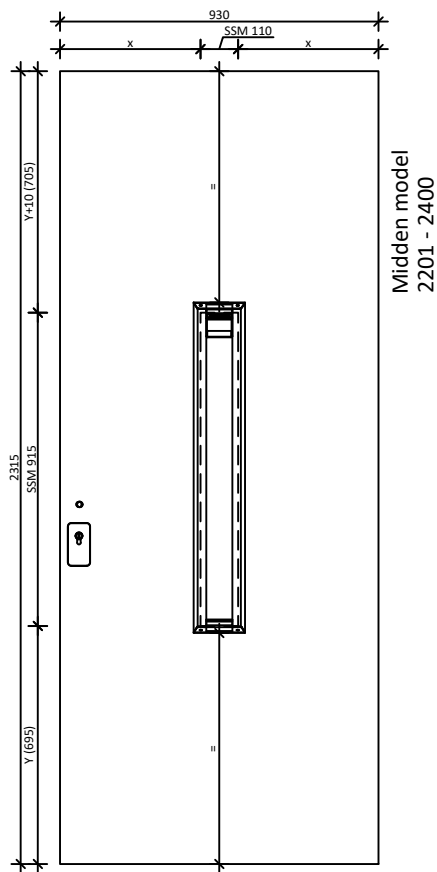
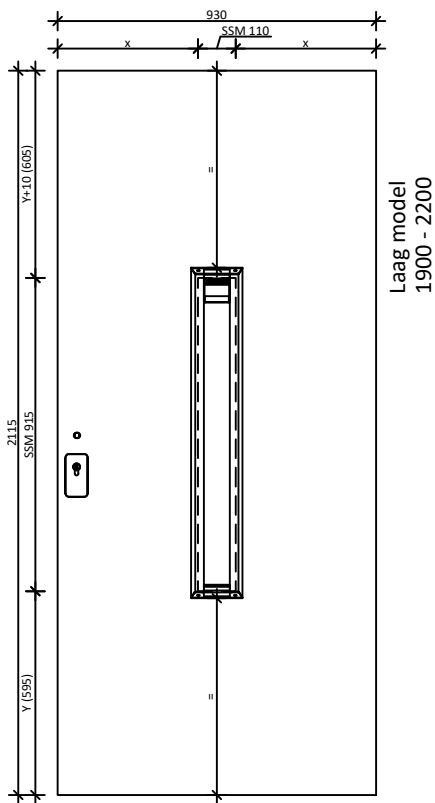

Kruk gat alleen aan binnenzijde, ivm combi rozet (cilinder en deurknop) als standaard

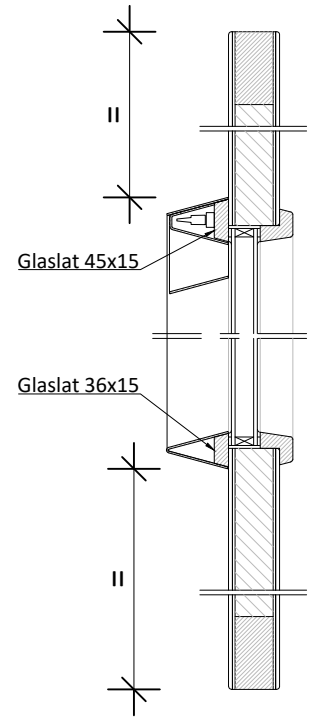
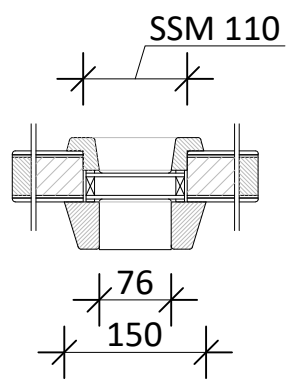

DATUM: 01-02-2024	GEWIJZIGD:	CALCULATIENR:	TEKENINGNR: 20230201-941-01	MODEL: 94104	HOUTSOORT:
			KLANT/PROJECT: Model 94104 Overzicht		DCM NUMMER:
			AANVRAAG:	SCHAAL:	GETEKEND: KF

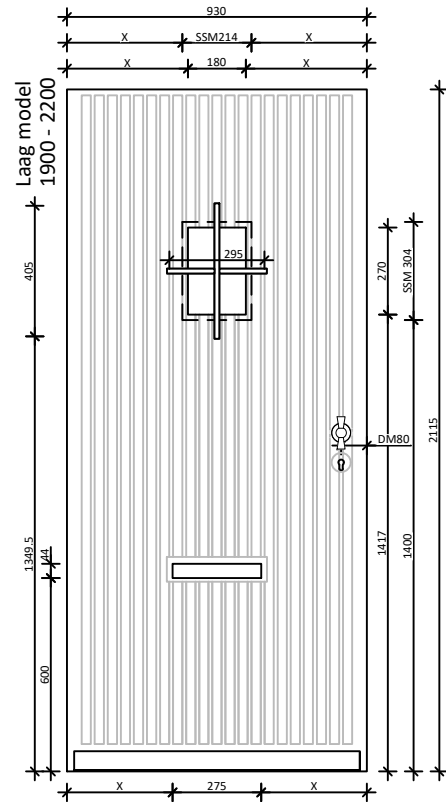
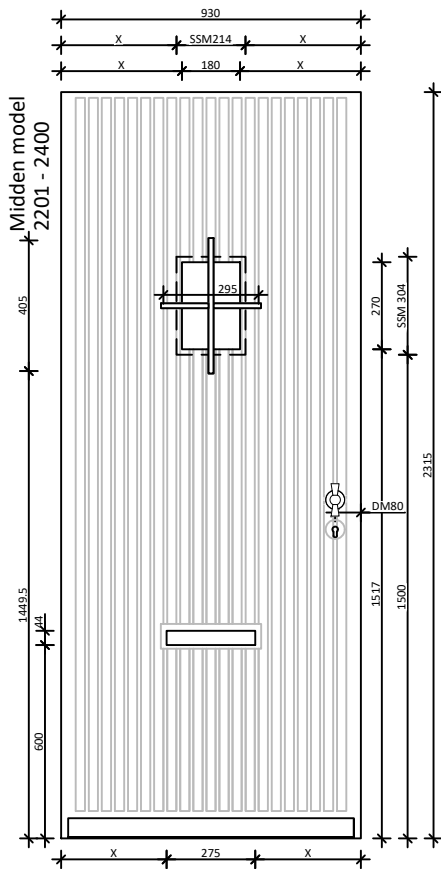

Glasvak afhankelijk van de deur breedte

1. 880 of smaller = ssm 199x284
2. tussen 880 en 1040 = ssm 214x304
3. 1040 of breder = ssm 244x354

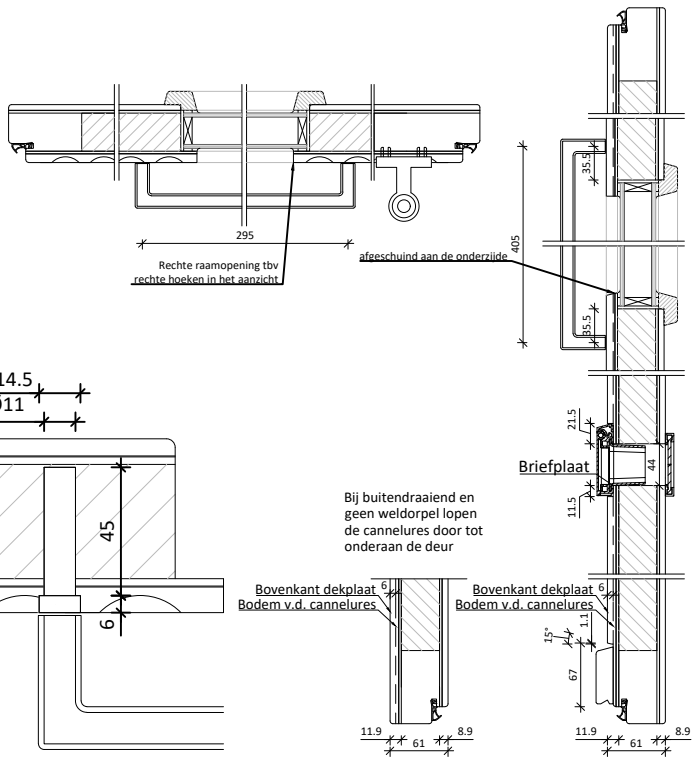
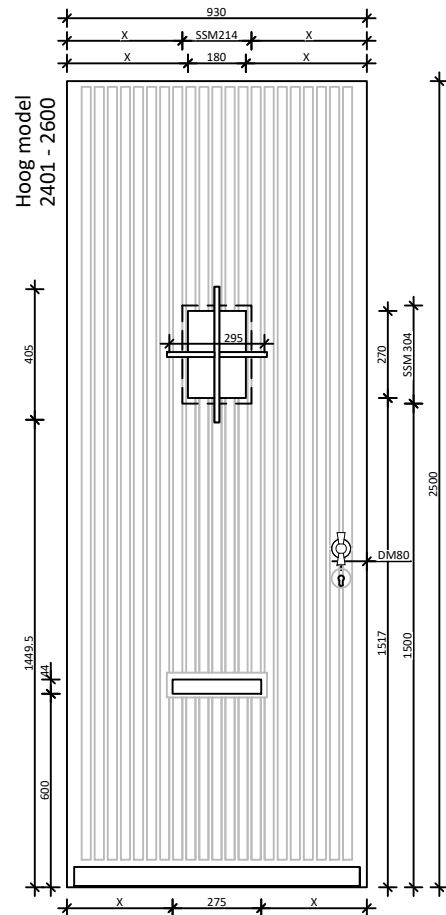

DATUM:
01-02-2024

GEWIJZIGD:

CALCULATIENR:

TEKENINGNR:
20240201-946-7-01

MODEL:
94601

HOUTSOORT:

KEGRO | DEUREN

KLANT/PROJECT:
overzicht modellen 94601

DCM NUMMER:

AANVRAAG:

SCHAAL:

GETEKEND:
KF

LEVERWEEK:

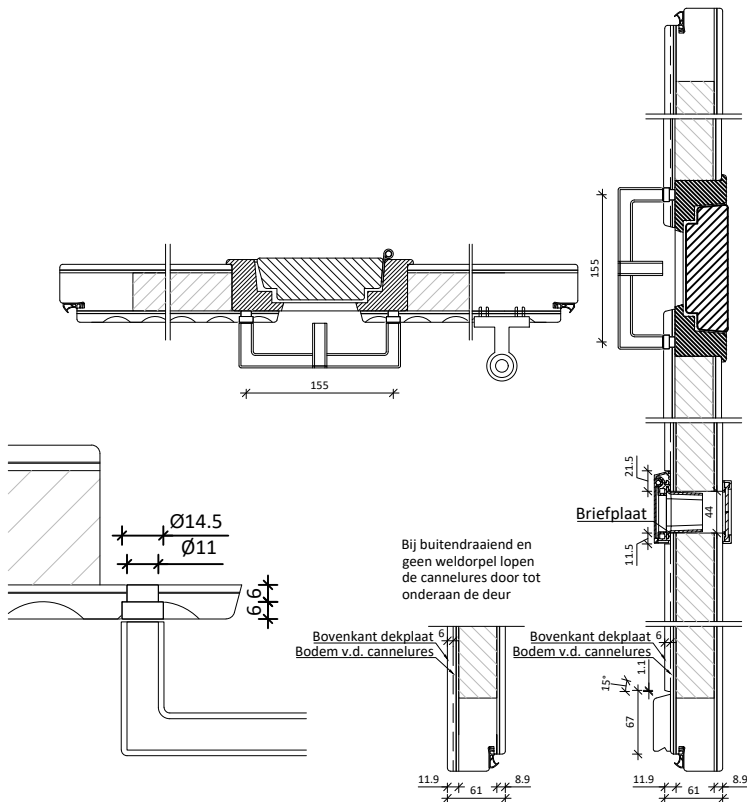
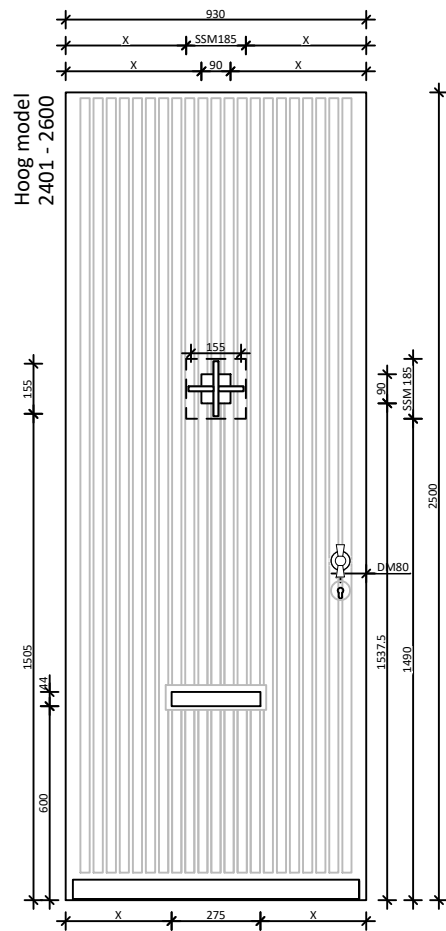
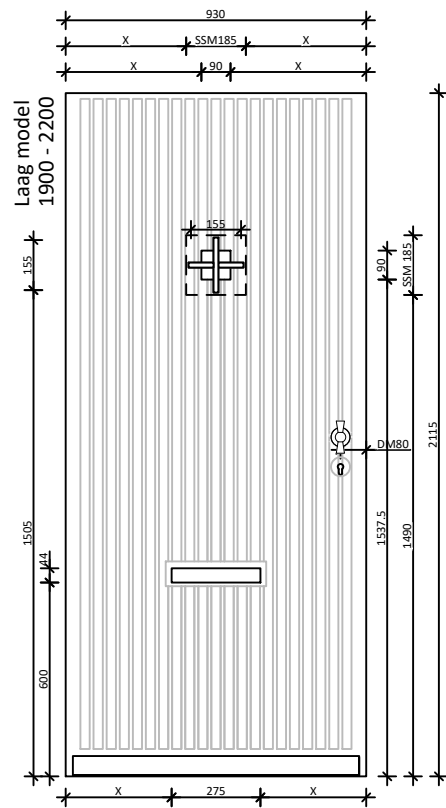
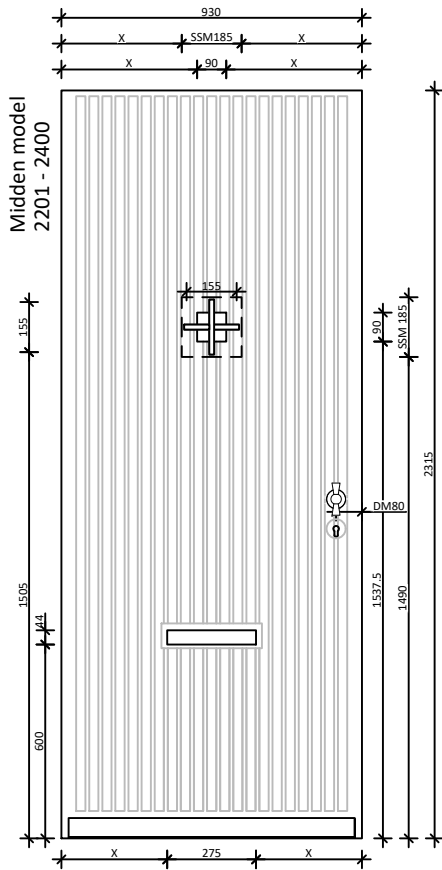

DATUM:
01-02-2024

GEWIJZIGD:

CALCULATIENR:

TEKENINGNR:
20240201-946-7-01

MODEL:
94602

HOUTSOORT:

KEGRO | DEUREN

KLANT/PROJECT:
overzicht modellen 94602

DCM NUMMER:

AANVRAAG:

SCHAAL:

GETEKEND:
KF

LEVERWEEK:

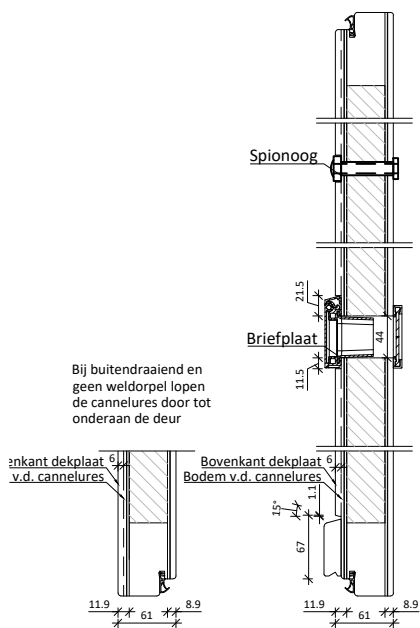
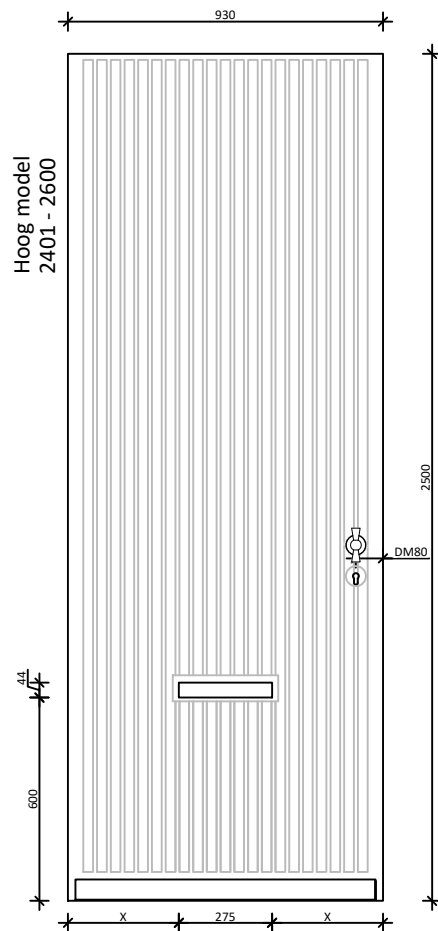
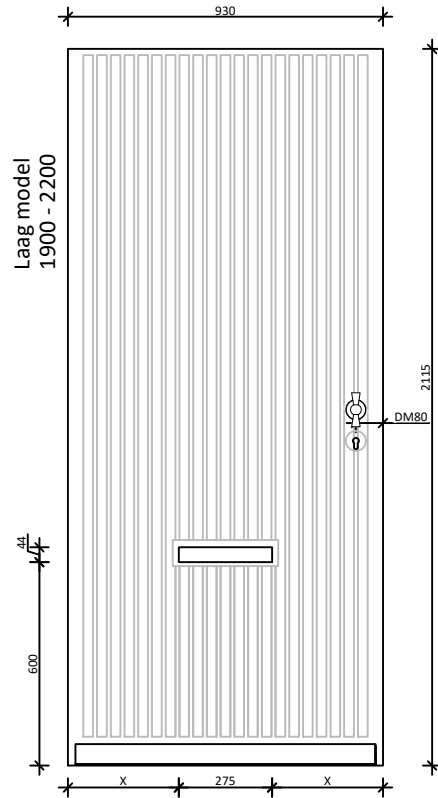
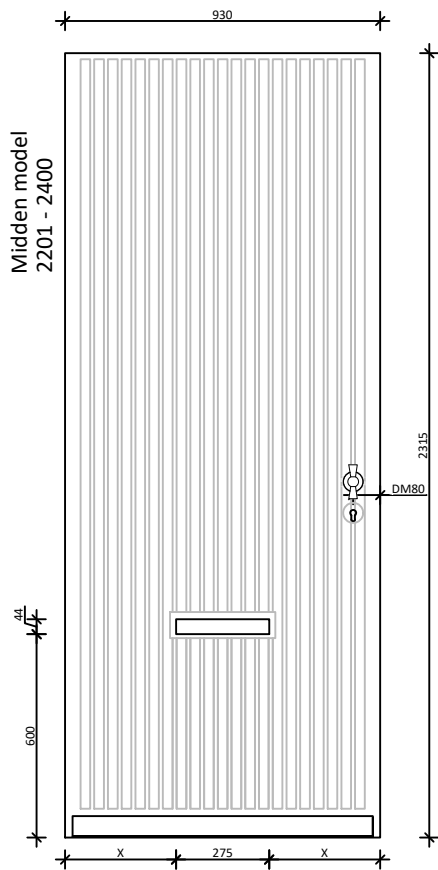

DATUM:
01-02-2024

GEWIJZIGD:

CALCULATIENR:

TEKENINGNR:
20240201-946-7-01

MODEL:
94603

HOUSOORT:

KEGRO | DEUREN

KLANT/PROJECT:
overzicht modellen 94603

DCM NUMMER:

AANVRAAG:

SCHAAL:

GETEKEND:
KF

LEVERWEEK:

Actieve deur

Passieve deur

Midden model
2201 - 2400

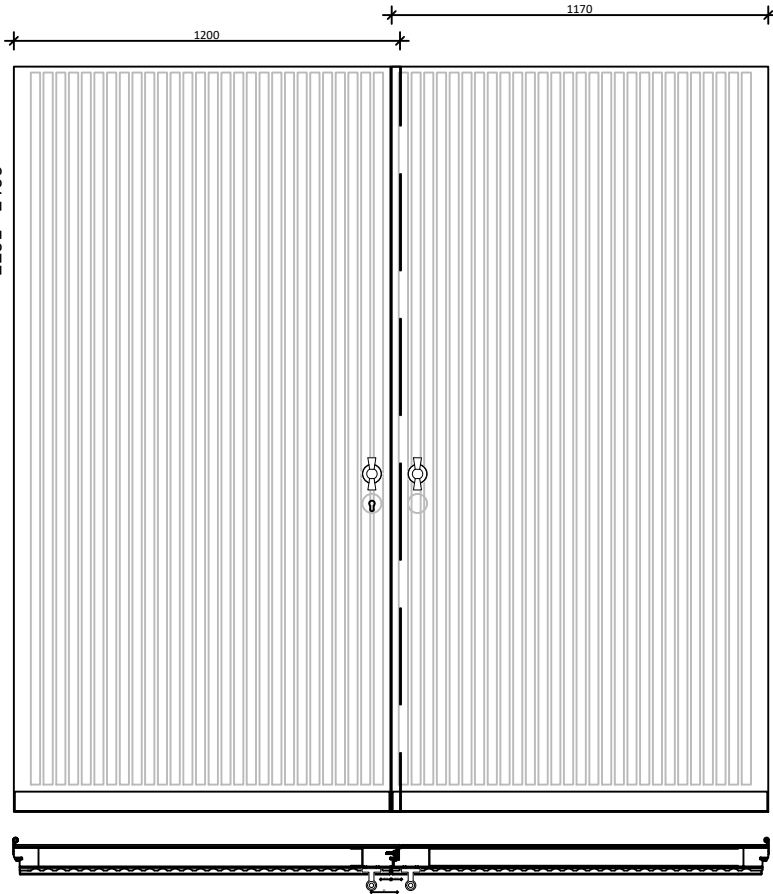

Midden model
2201 - 2400

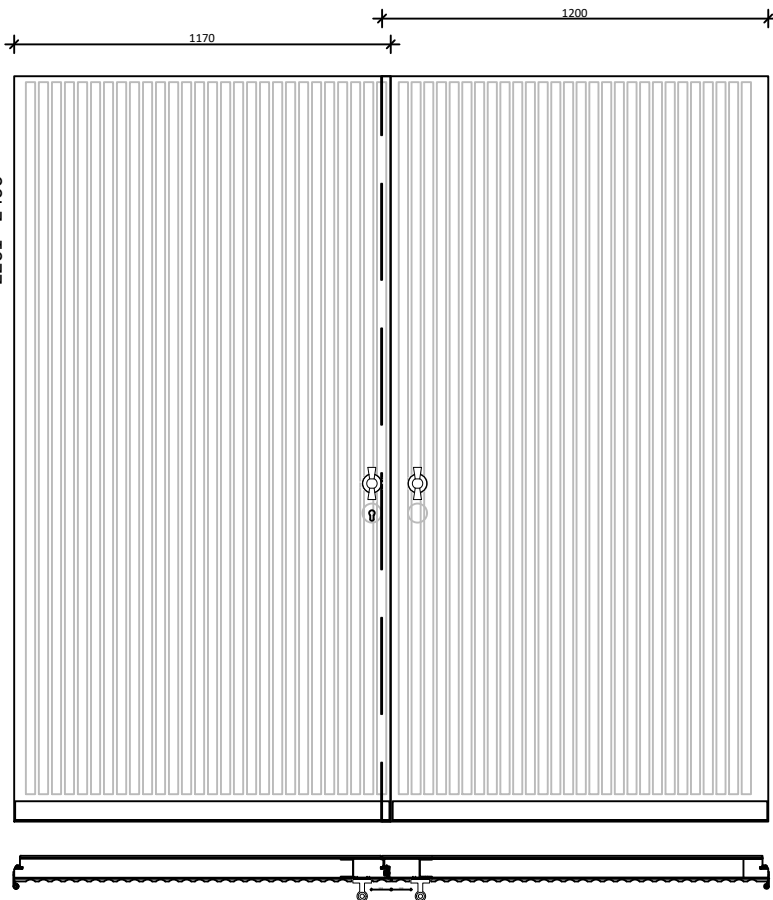

Beide deur modellen zijn gelijk aan model 94603. Voor hoog midden laag modellen zie 94603

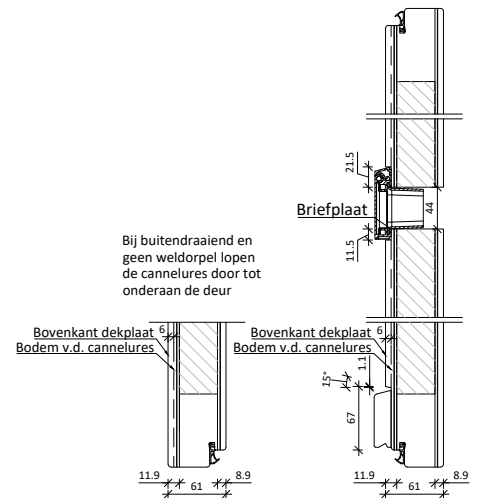
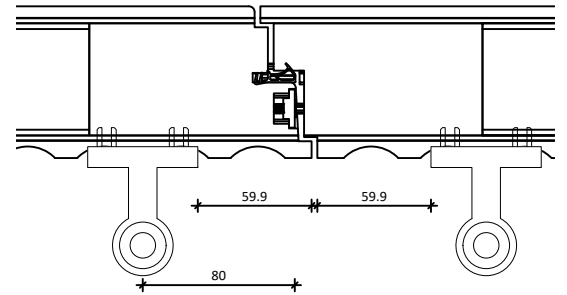
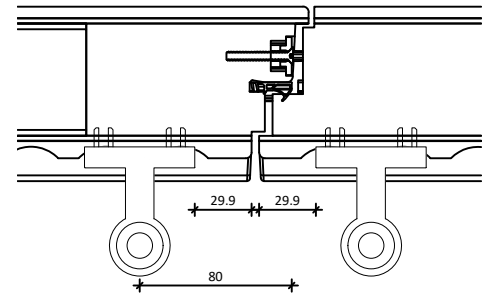

DATUM:
01-02-2024

GEWIJZIGD:

CALCULATIENR:

TEKENINGNR:
20240201-946-7-01

MODEL:
94604

HOUSOORT:

KEGRO | DEUREN

KLANT/PROJECT:
overzicht modellen 94604

DCM NUMMER:

AANVRAAG:

SCHAAL:

GETEKEND:
KF

LEVERWEEK:

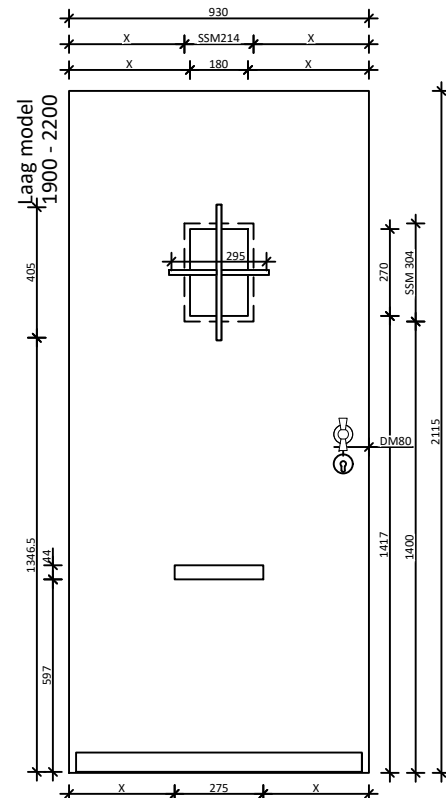
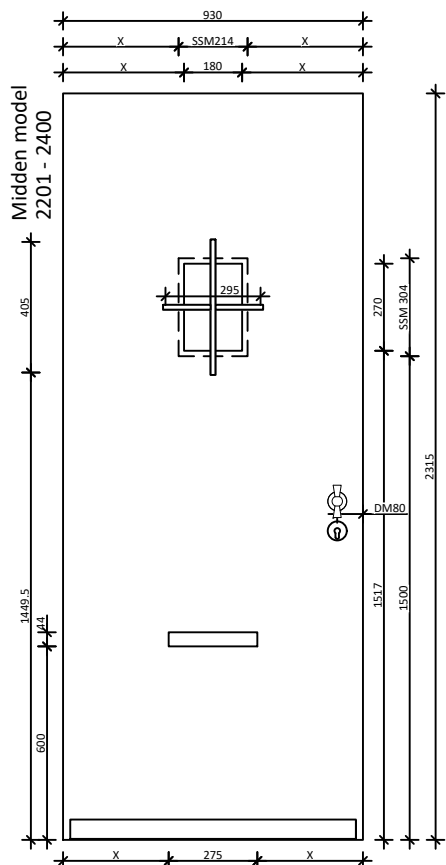

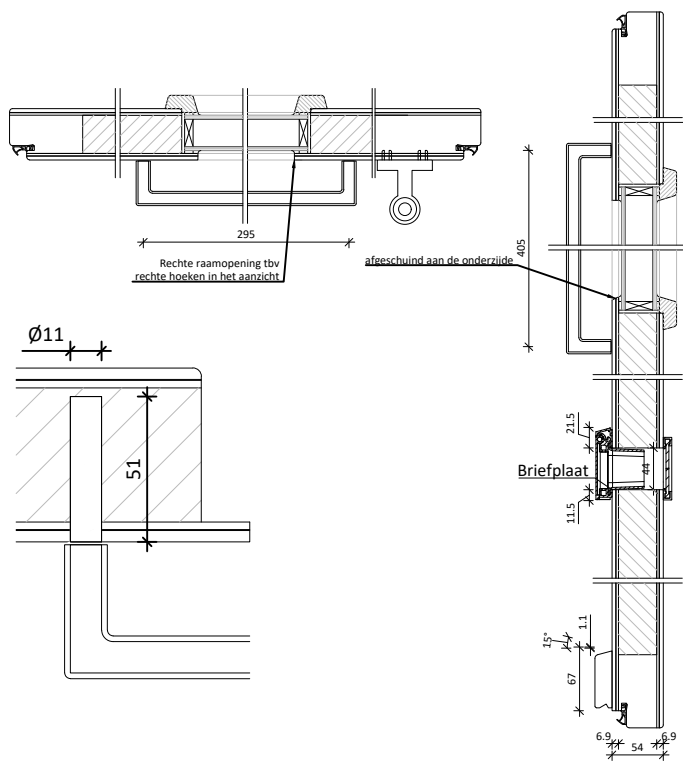
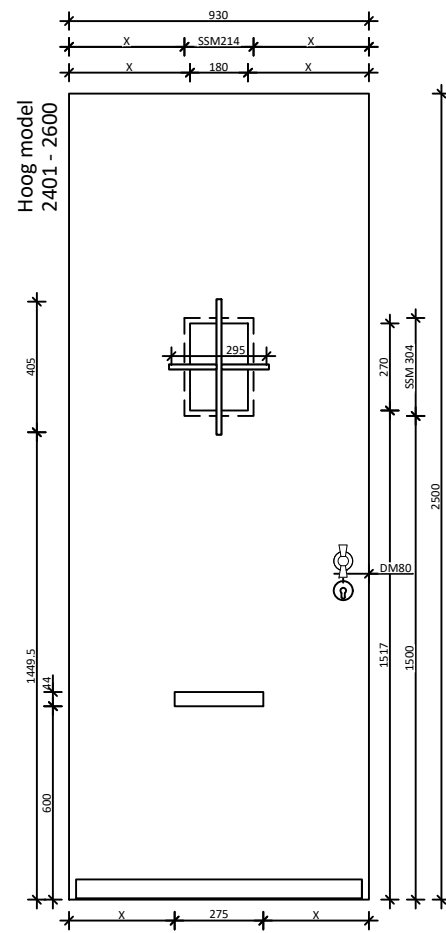

Glasvak afhankelijk van de deur breedte

1. 880 of smaller = ssm 199x284
2. tussen 880 en 1040 = ssm 214x304
3. 1040 of breder = ssm 244x354

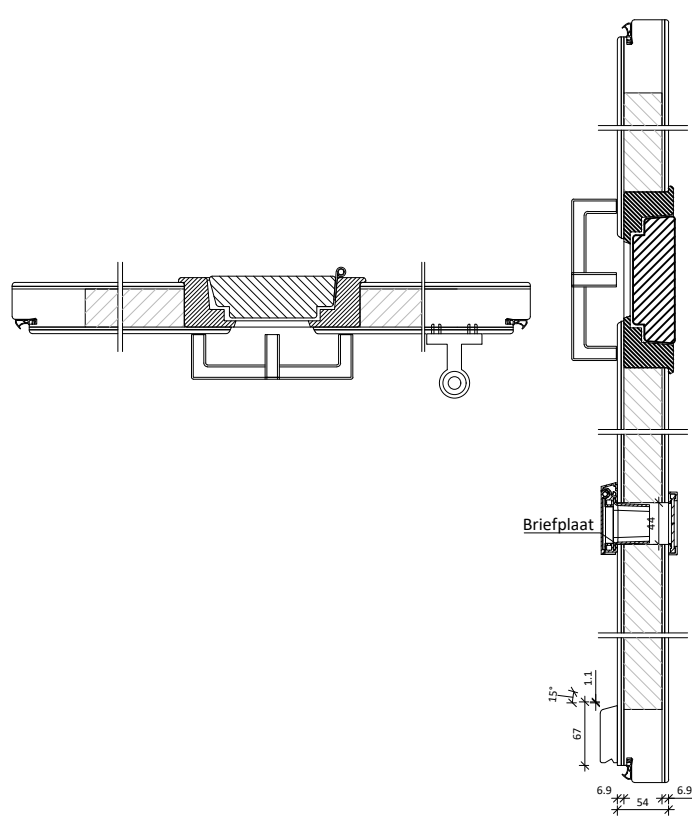
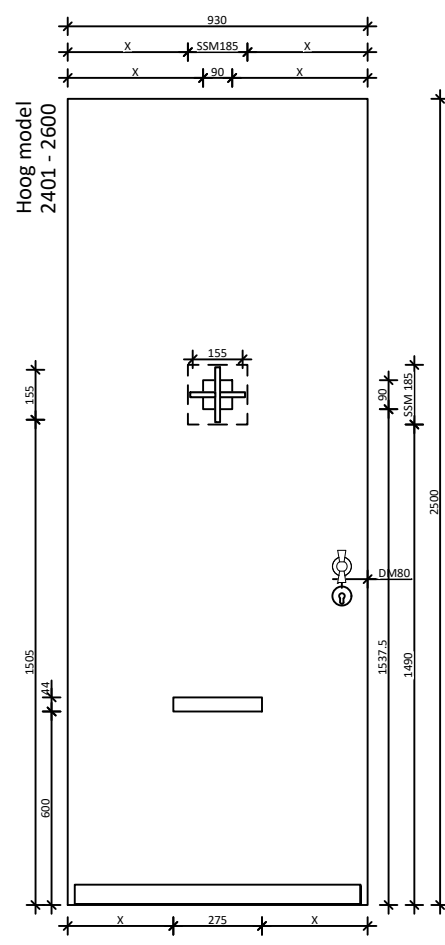
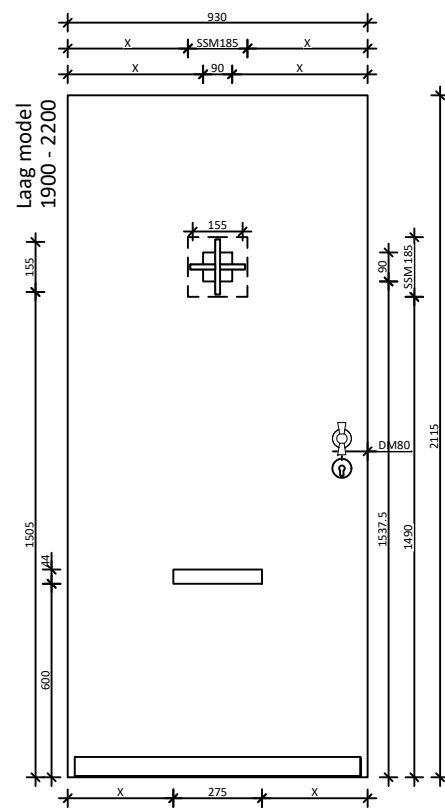
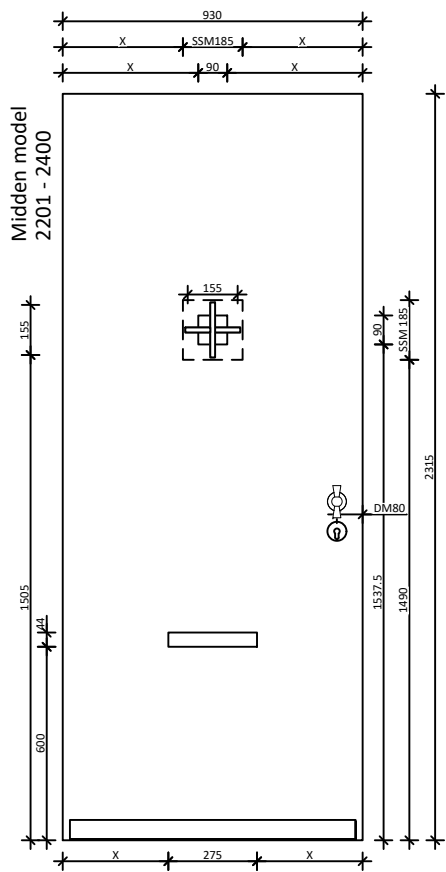

DATUM: 01-02-2024	GEWIJZIGD:	CALCULATIENR:	TEKENINGNR: 20240201-946-7-01	MODEL: 94701	HOUTSOORT:
			KLANT/PROJECT: overzicht modellen 94701		DCM NUMMER:
AANVRAAG:		SCHAAL:	GETEKEND: KF	LEVERWEEK:	
1.2a P.123					



DATUM: 01-02-2024	GEWIJZIGD:	CALCULATIENR:	TEKENINGNR: 20240201-946-7-01	MODEL: 94702	HOUTSOORT:
			KLANT/PROJECT: overzicht modellen 94702		DCM NUMMER:
			AANVRAAG:	SCHAAL:	GETEKEND: KF

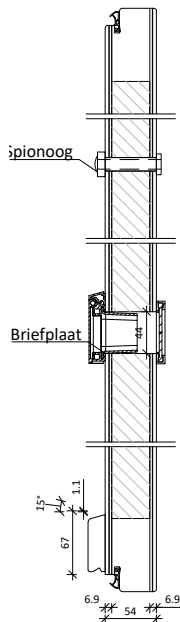
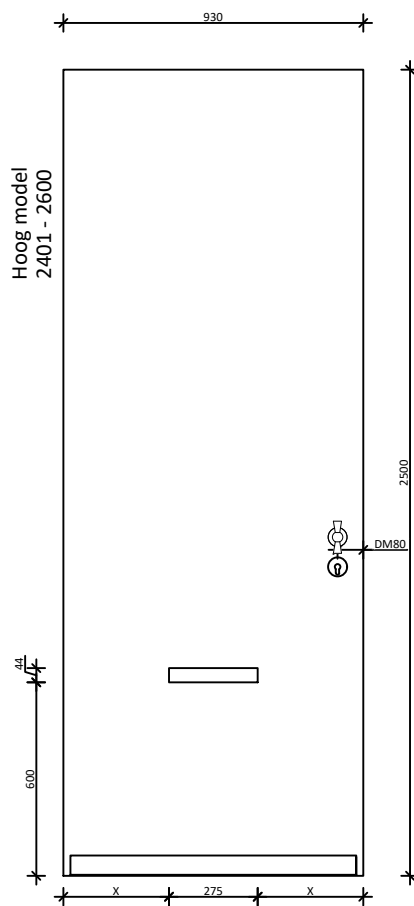
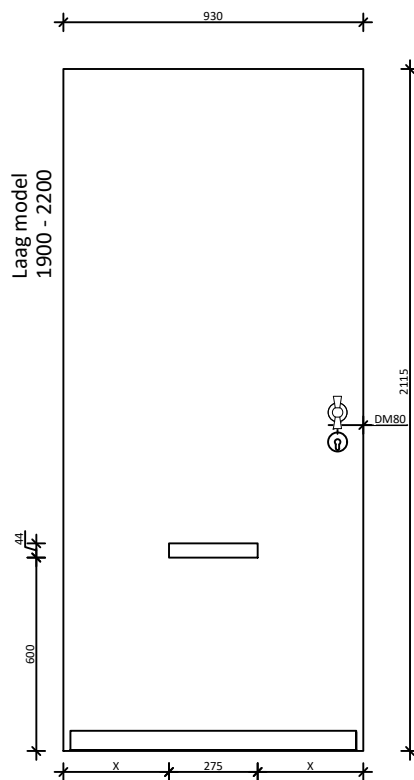
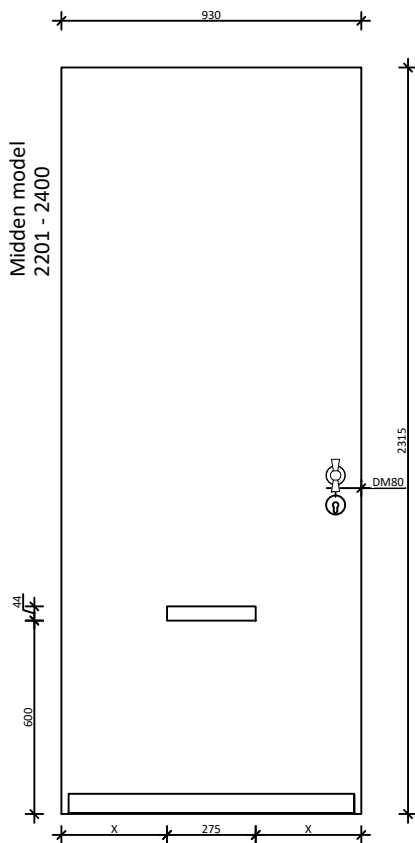

DATUM:
01-02-2024

GEWIJZIGD:

CALCULATIENR:

TEKENINGNR:
20240201-946-7-01

MODEL:
94703

HOUTSOORT:

KEGRO | DEUREN

KLANT/PROJECT:
overzicht modellen 94703

DCM NUMMER:

AANVRAAG:

SCHAAL:

GETEKEND:
KF

LEVERWEEK:

Midden model
2201 - 2400

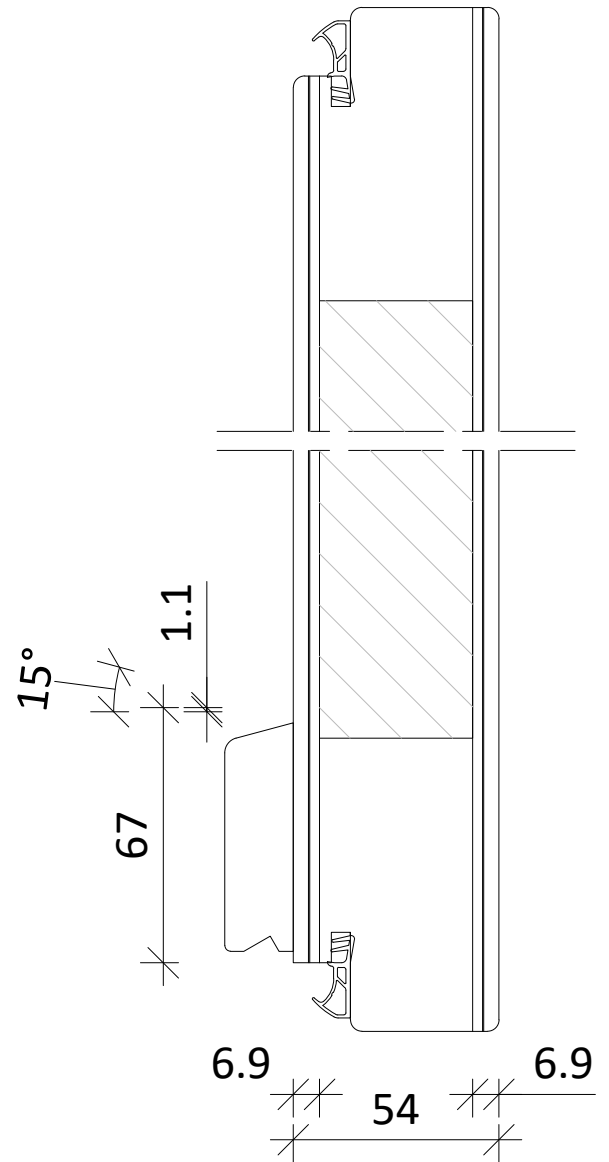
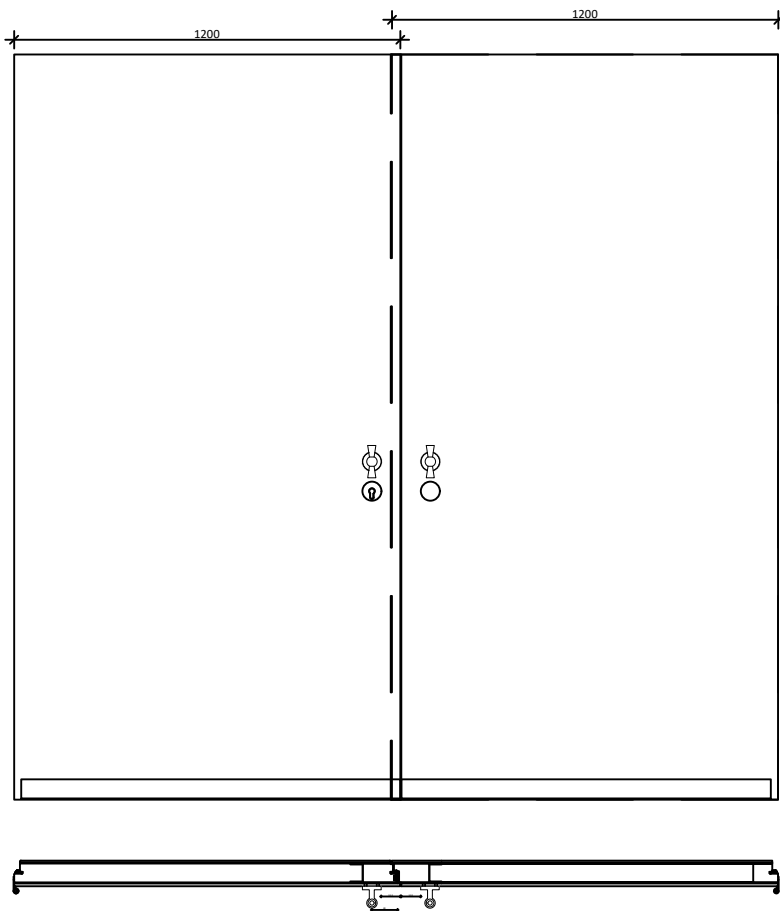
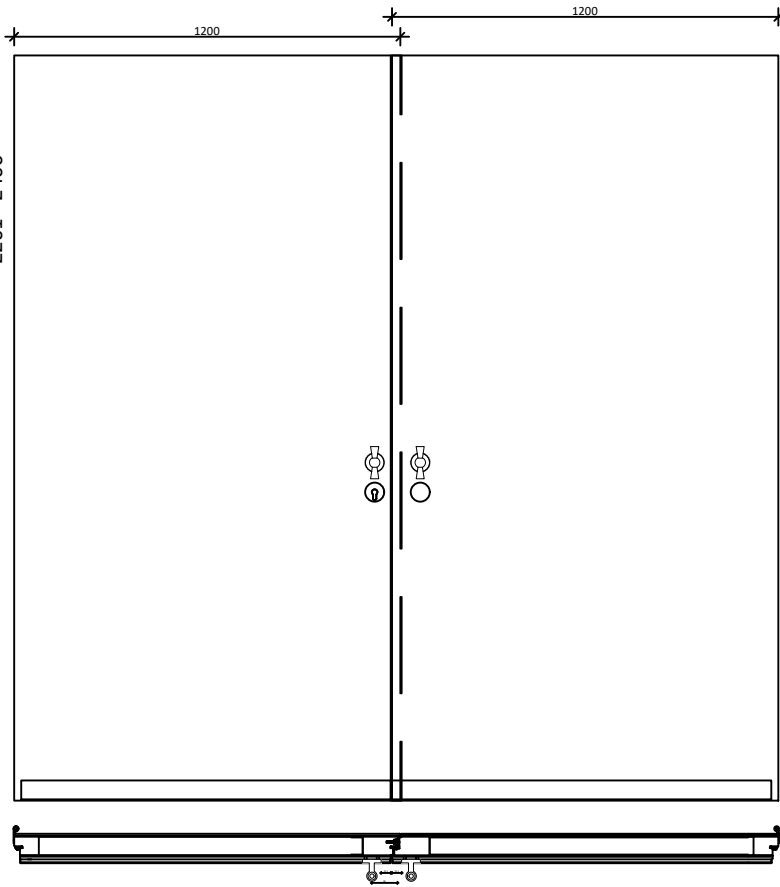

DATUM:
01-02-2024

GEWIJZIGD:
14-03-2024

CALCULATIENR:

TEKENINGNR:
20240201-946-7-01

MODEL:
94704

HOUTSOORT:

KEGRO | DEUREN

KLANT/PROJECT:
overzicht modellen 94704

DCM NUMMER:

AANVRAAG:

SCHAAL:

GETEKEND:
KF

LEVERWEEK:

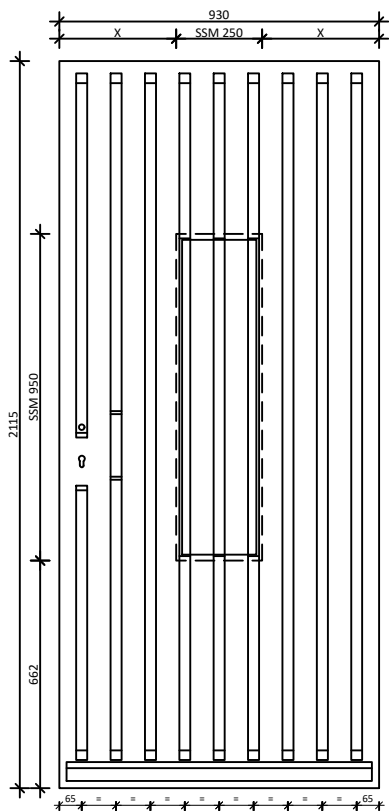

Laag model
1900 - 2200

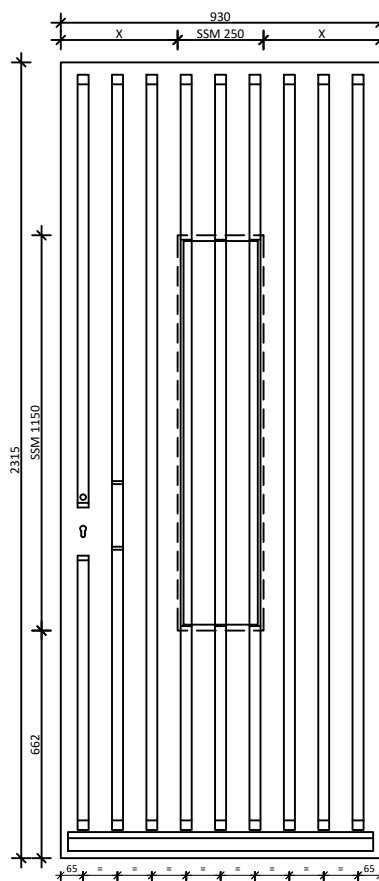

Midden model
2201 - 2400

Type latten C B A F F F A A A

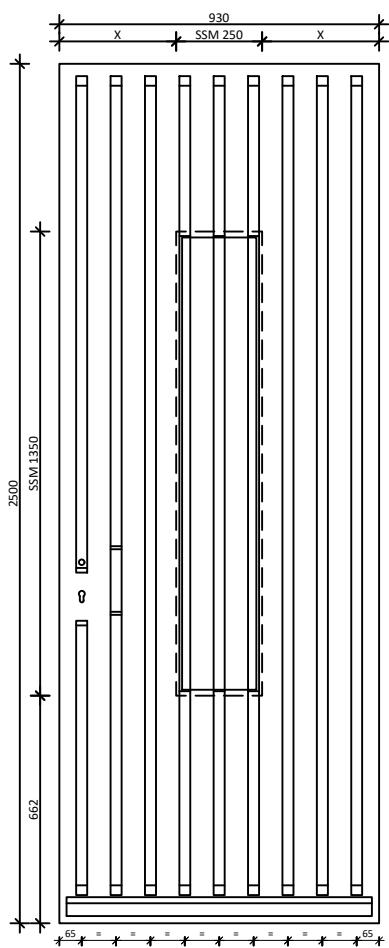

Hoog model
2401 - 2600

smaller dan 689 mm in overleg
 689 mm tot 789mm = 7 latten
 790mm tot 879mm = 8 latten
 880mm tot 974mm = 9 latten
 975mm tot 1074mm = 10 latten
 1075mm tot 1174mm = 11 latten
 vanaf 1175mm = 12 latten

DATUM: 13-02-2024	GEWIJZIGD:	CALCULATIENR:	TEKENINGNR: 20240213-944-01	MODEL: 94401	HOUSOORT:
----------------------	------------	---------------	--------------------------------	-----------------	-----------

KEGRO | DEUREN

KLANT/PROJECT: Model 94401 Overzicht			DCM NUMMER:
---	--	--	-------------

AANVRAAG:	SCHAAL:	GETEKEND: KF	LEVERWEEK:
-----------	---------	-----------------	------------

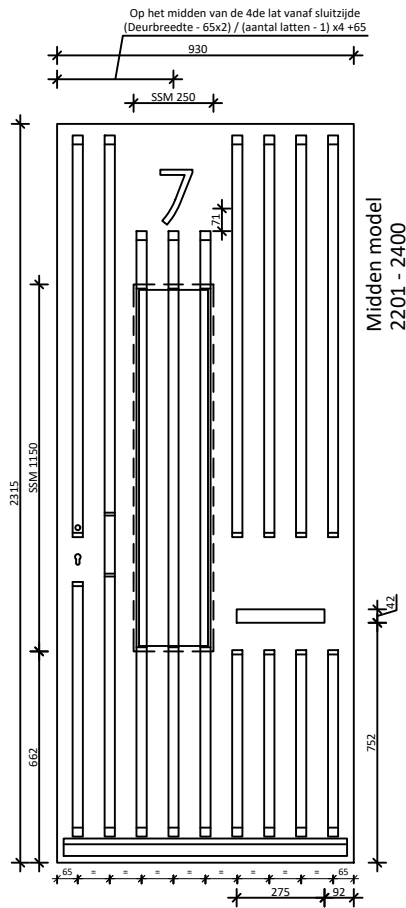
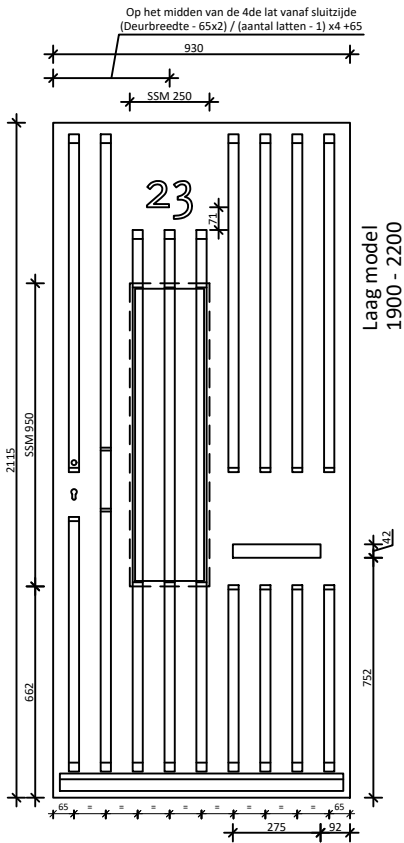

Type latten C B G G G D D D D

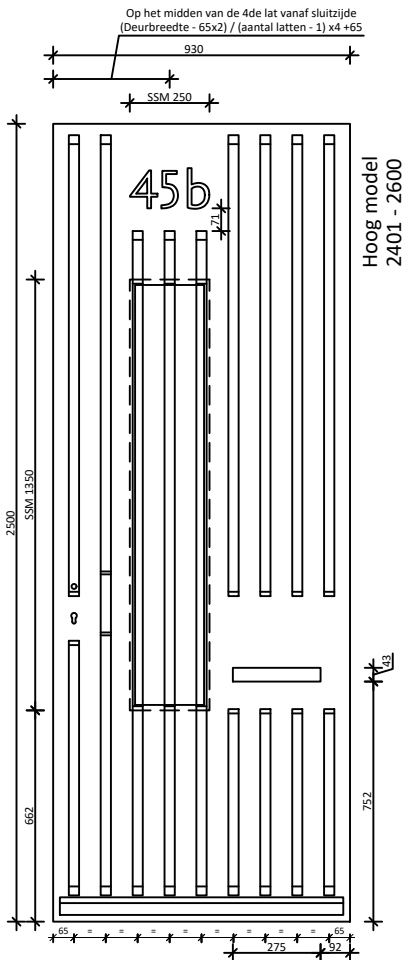

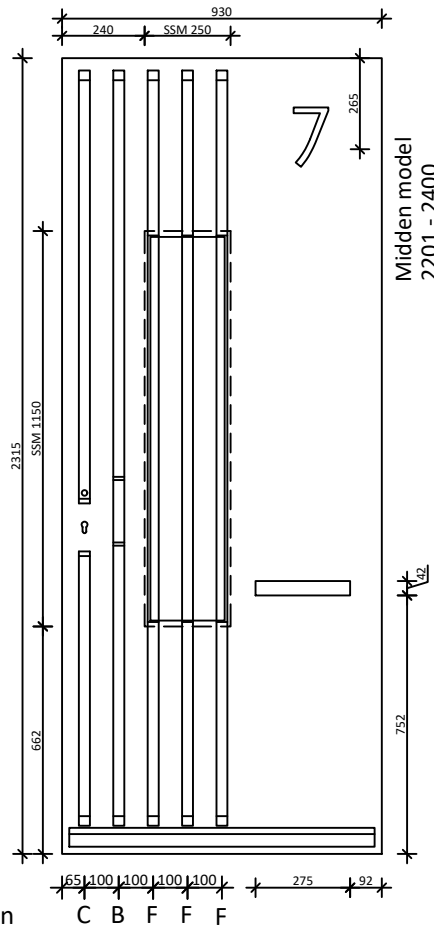
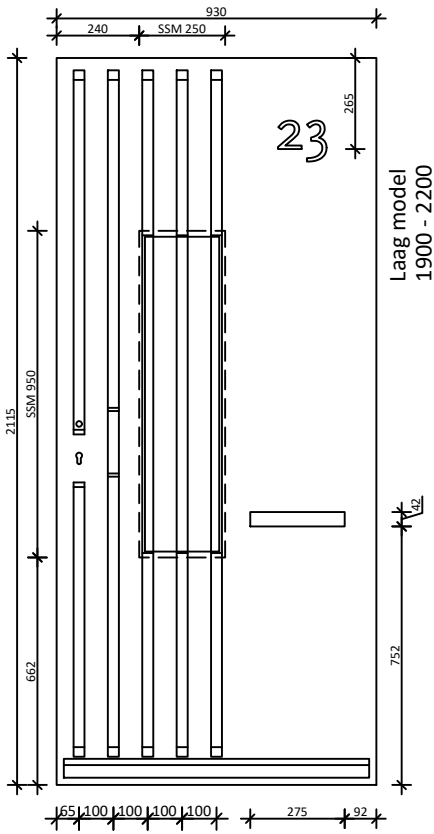

Smaller dan 880mm breed zie model 94408 ivm briefplaat die niet meer naast het glasvak past.
 880mm tot 974mm = 9 latten
 975mm tot 1074mm = 10 latten
 1075mm tot 1174mm = 11 latten
 vanaf 1175mm = 12 latten

DATUM: 13-02-2024	GEWIJZIGD:	CALCULATIENR:	TEKENINGNR: 20240213-944-01	MODEL: 94402	HOUSOORT:
			KLANT/PROJECT: Model 94402 Overzicht		DCM NUMMER:
			AANVRAAG:	SCHAAL:	GETEKEND: KF

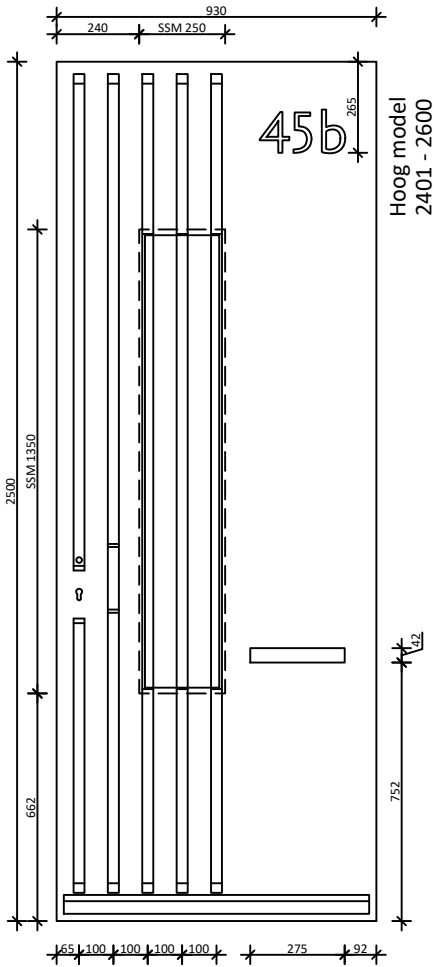

Type latten



DATUM: 13-02-2024	GEWIJZIGD:	CALCULATIENR:	TEKENINGNR: 20240213-944-01	MODEL: 94403	HOUSOORT:
			KLANT/PROJECT: Model 94403 Overzicht		DCM NUMMER:
			AANVRAAG:	SCHAAL:	GETEKEND: KF

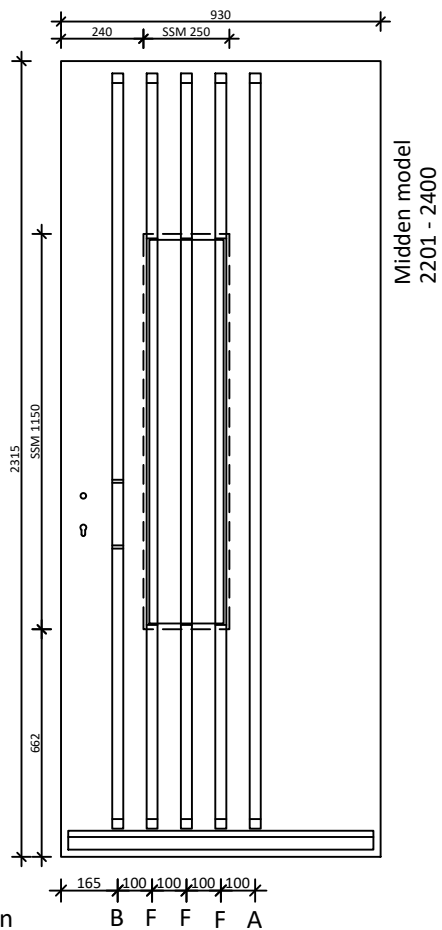
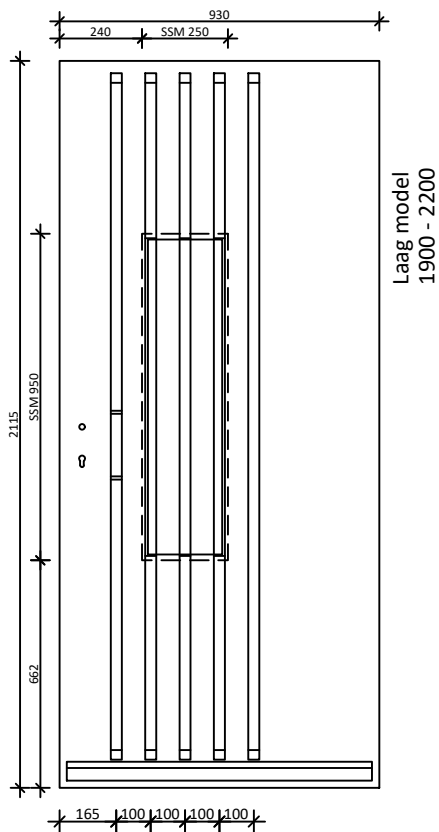

Type latten

B F F F A

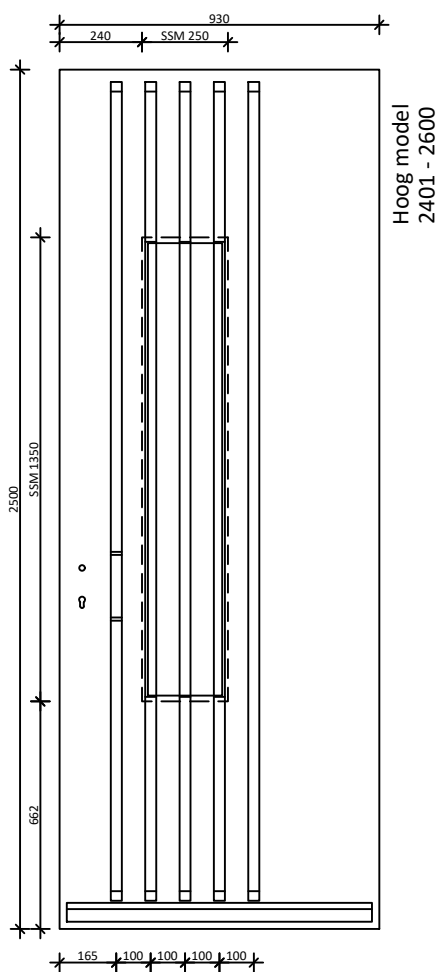



DATUM: 13-02-2024	GEWIJZIGD:	CALCULATIENR:	TEKENINGNR: 20240213-944-01	MODEL: 94404	HOUTSOORT:
----------------------	------------	---------------	--------------------------------	-----------------	------------

KEGRO | DEUREN

KLANT/PROJECT: Model 94404 Overzicht			DCM NUMMER:
---	--	--	-------------

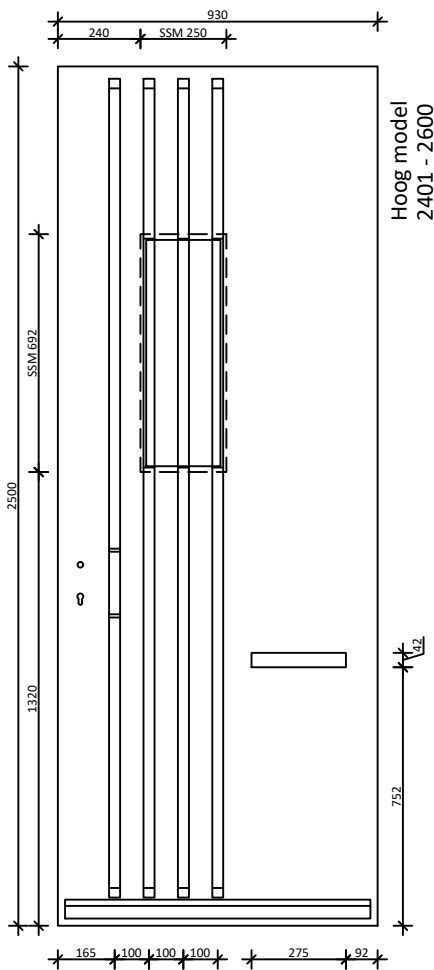
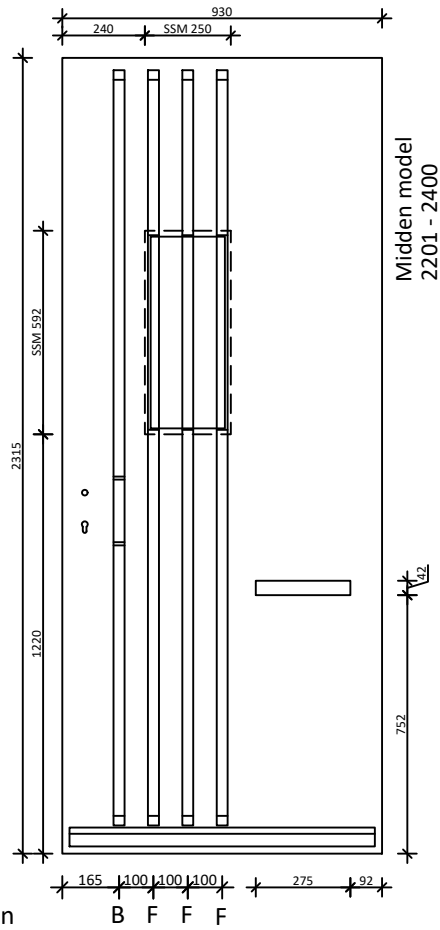
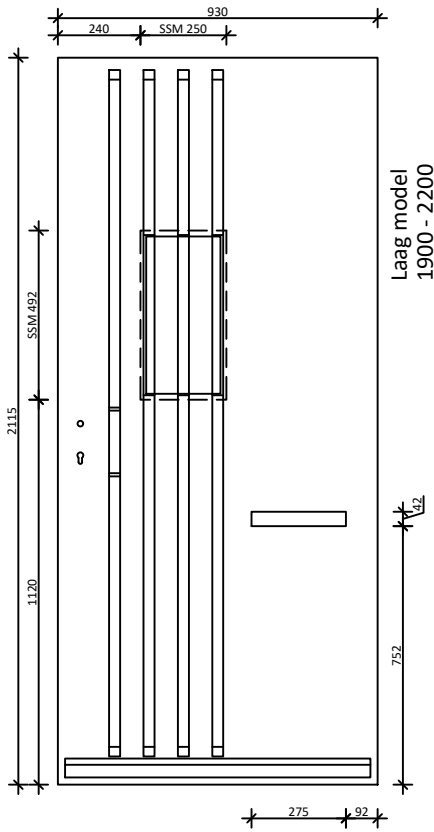
AANVRAAG:	SCHAAL:	GETEKEND: KF	LEVERWEEK:
-----------	---------	-----------------	------------



DATUM: 13-02-2024	GEWIJZIGD:	CALCULATIENR:	TEKENINGNR: 20240213-944-01	MODEL: 94405	HOUTSOORT:
			KLANT/PROJECT: Model 94405 Overzicht		DCM NUMMER:
			AANVRAAG:	SCHAAL:	GETEKEND: KF

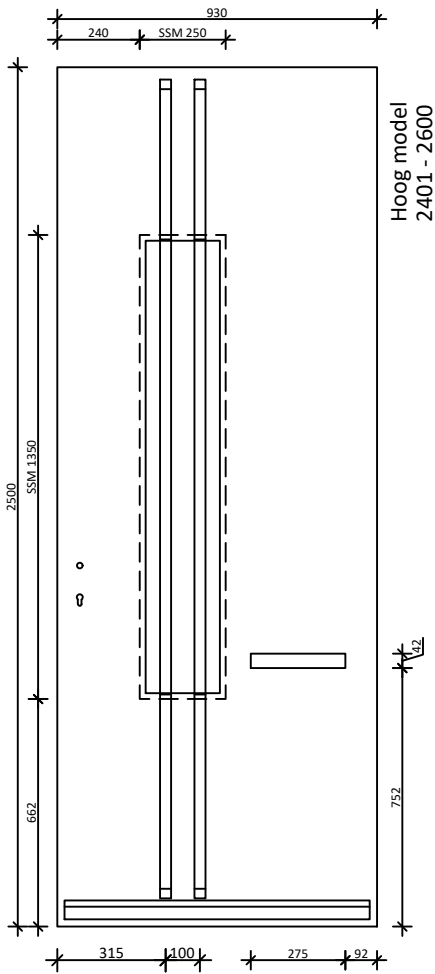
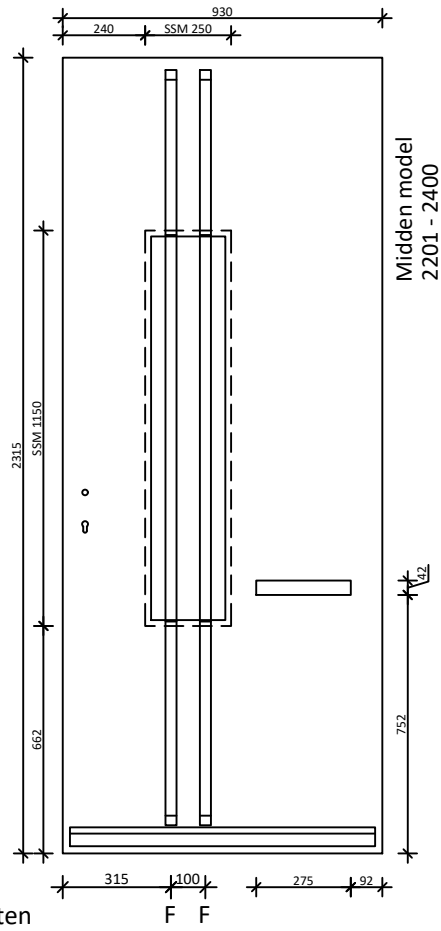
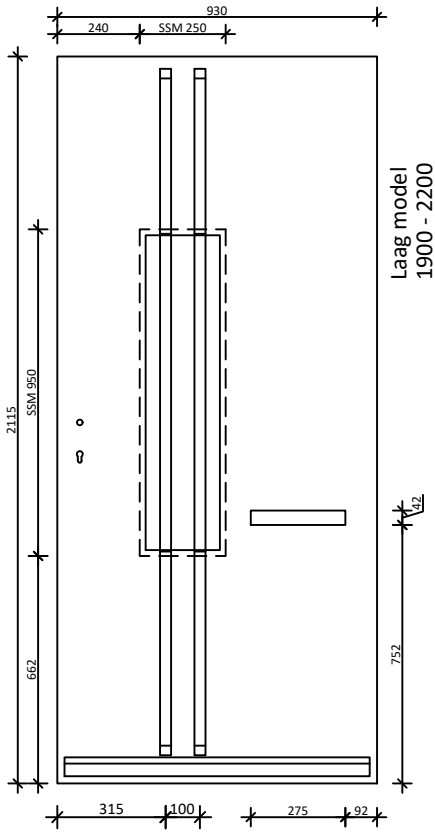

DATUM:
13-02-2024

GEWIJZIGD:

CALCULATIENR:

TEKENINGNR:
20240213-944-01

MODEL:
94406

HOUSOORT:

KEGRO | DEUREN

KLANT/PROJECT:
Model 94406 Overzicht

DCM NUMMER:

AANVRAAG:

SCHAAL:

GETEKEND:
KF

LEVERWEEK:

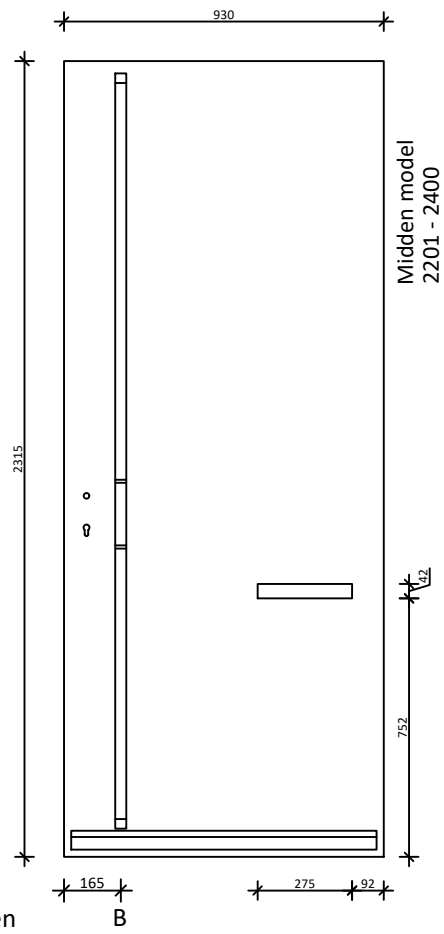
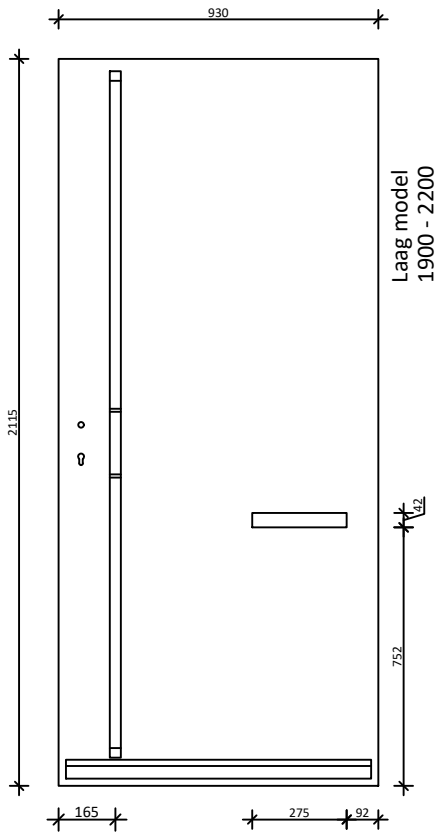

Type latten

B

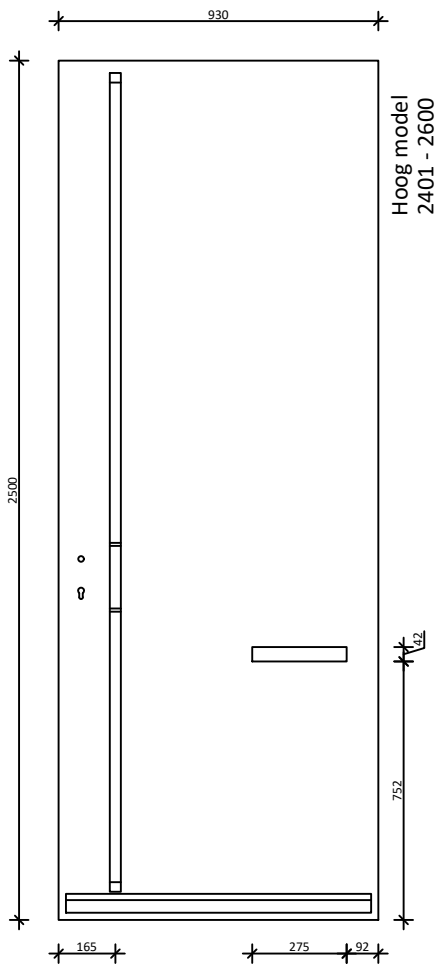

DATUM:
13-02-2024

GEWIJZIGD:

CALCULATIENR:

TEKENINGNR:
20240213-944-01

MODEL:
94407

HOUTSOORT:

KEGRO | DEUREN

KLANT/PROJECT:
Model 94407 Overzicht

DCM NUMMER:

AANVRAAG:

SCHAAL:

GETEKEND:
KF

LEVERWEEK:

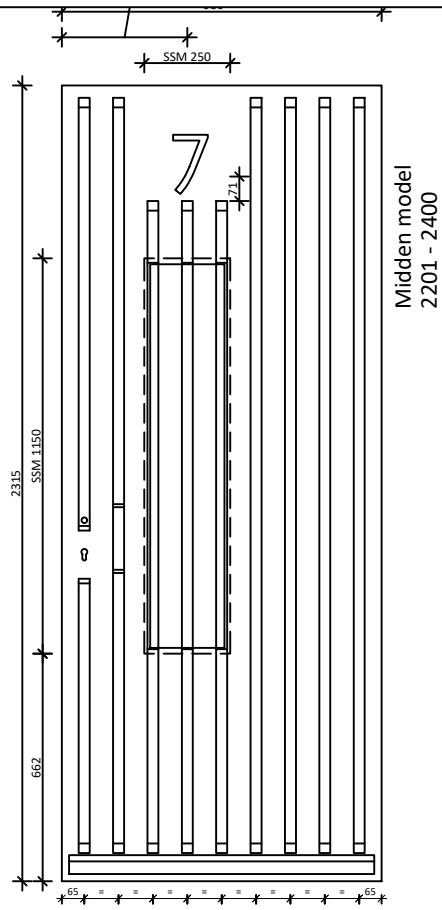
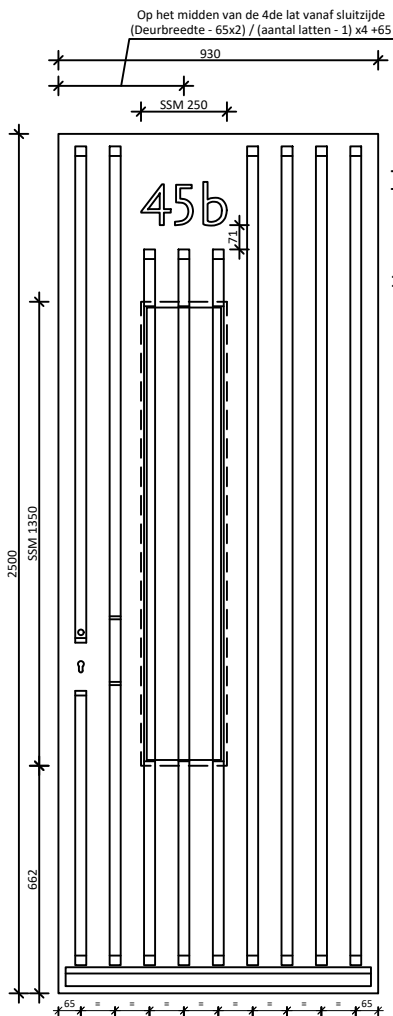
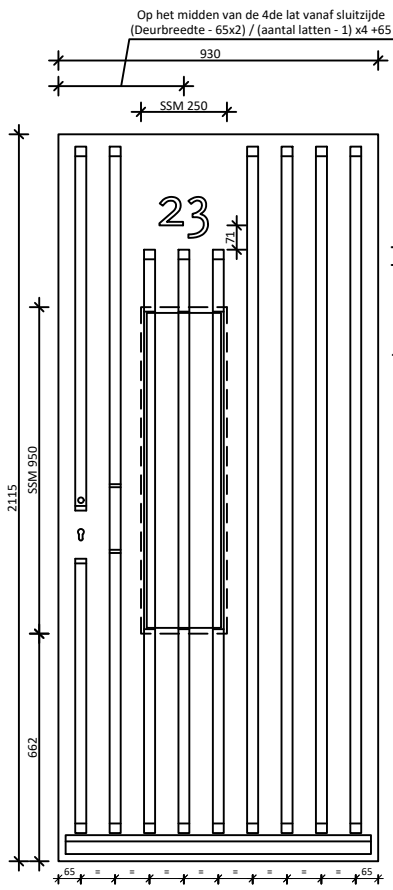

Type latten C B G G G A A A A

- Smaller dan 689 mm in overleg (alleen zonder briefplaat)
- 689 mm to 789mm = 7 latten (alleen zonder briefplaat)
- 790mm tot 879mm = 8 latten (alleen zonder briefplaat)
- 880mm tot 974mm = 9 latten
- 975mm tot 1074mm = 10 latten
- 1075mm tot 1174mm = 11 latten
- vanaf 1175mm = 12 latten

DATUM: 13-02-2024	GEWIJZIGD:	CALCULATIENR:	TEKENINGNR: 20240213-944-01	MODEL: 94408	HOUSOORT:
			KLANT/PROJECT: Model 94408 Overzicht		DCM NUMMER:
			AANVRAAG:	SCHAAL:	GETEKEND: KF

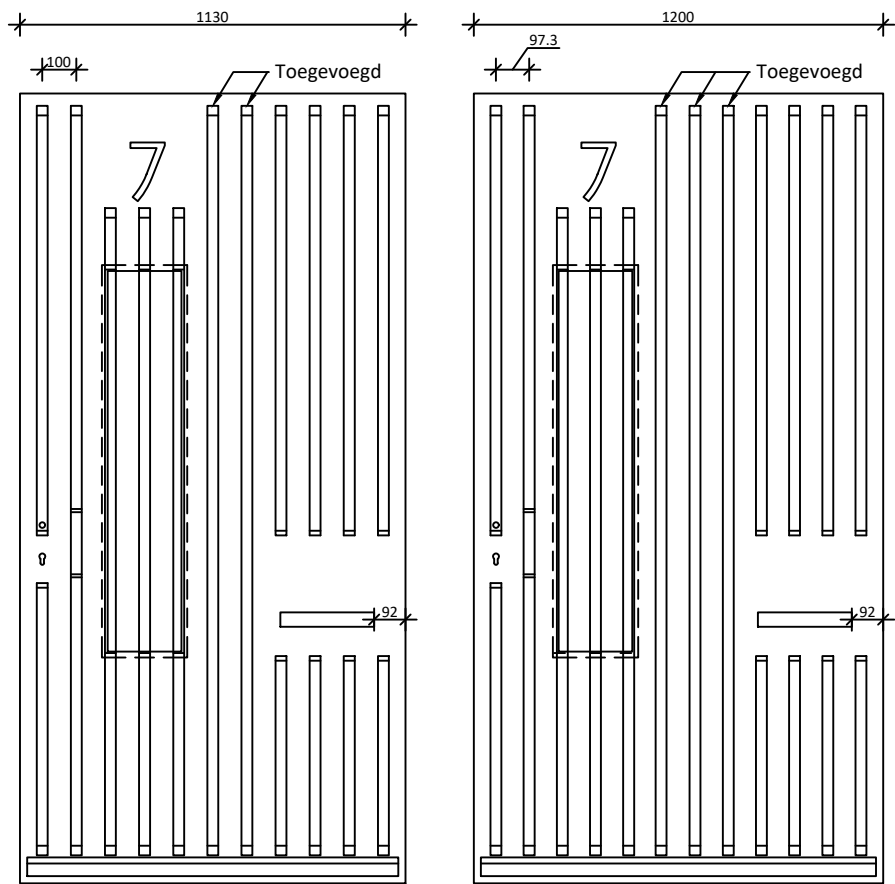
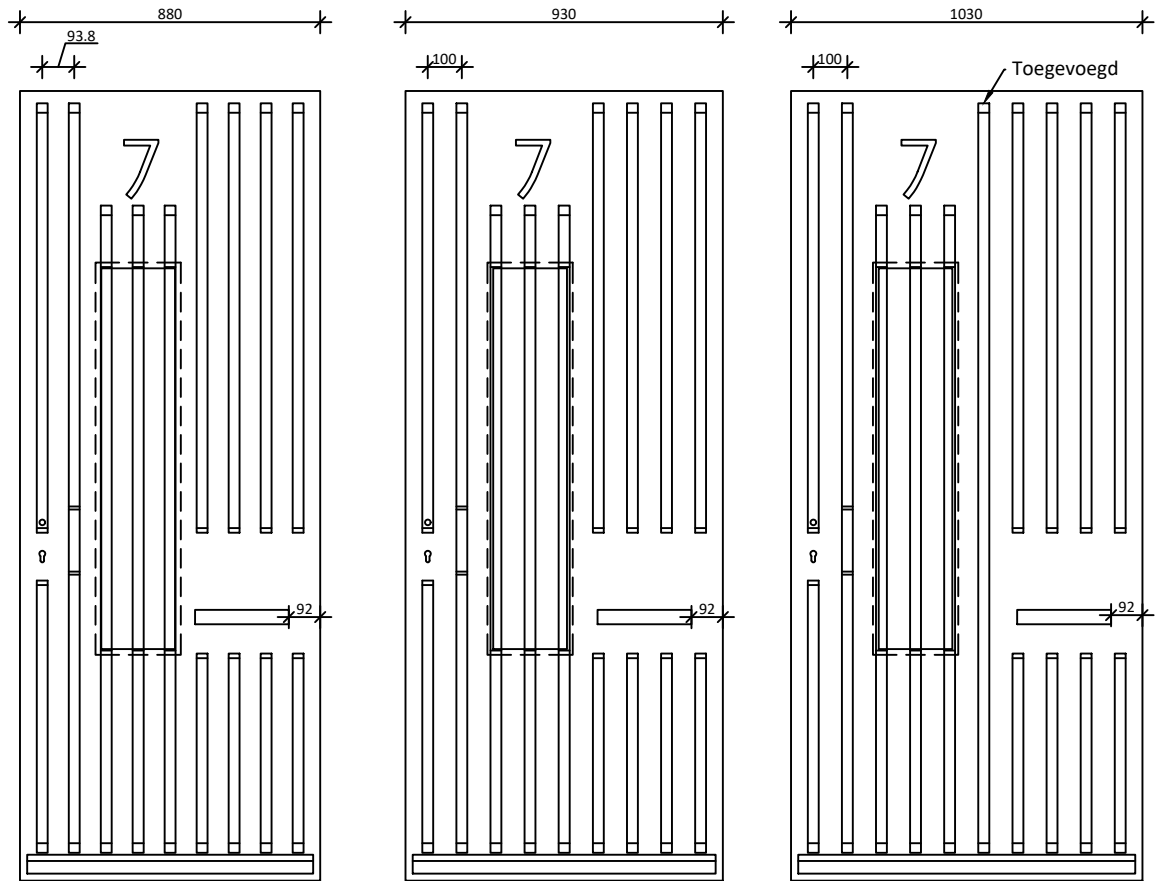

DATUM:
13-02-2024

GEWIJZIGD:

CALCULATIENR:

TEKENINGNR:
20240213-944-01

MODEL:
94402

HOUTSOORT:

KEGRO | DEUREN

KLANT/PROJECT:
Model 94402 Overzicht - breedte varianten

DCM NUMMER:

AANVRAAG:

SCHAAL:

GETEKEND:
KF

LEVERWEEK:

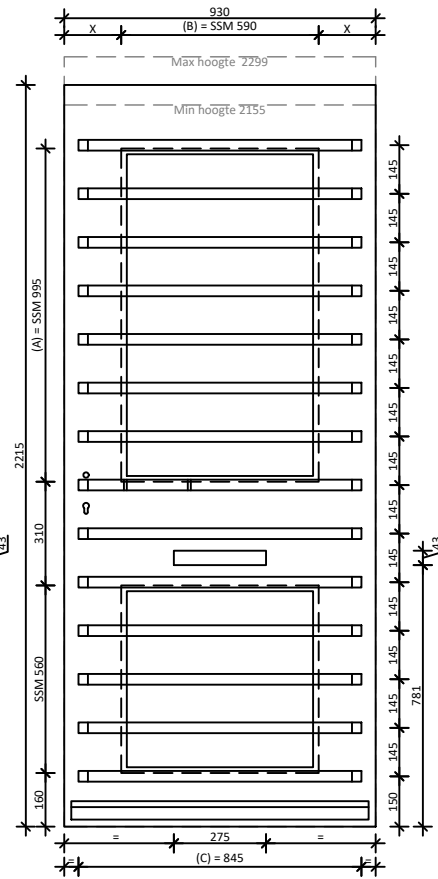
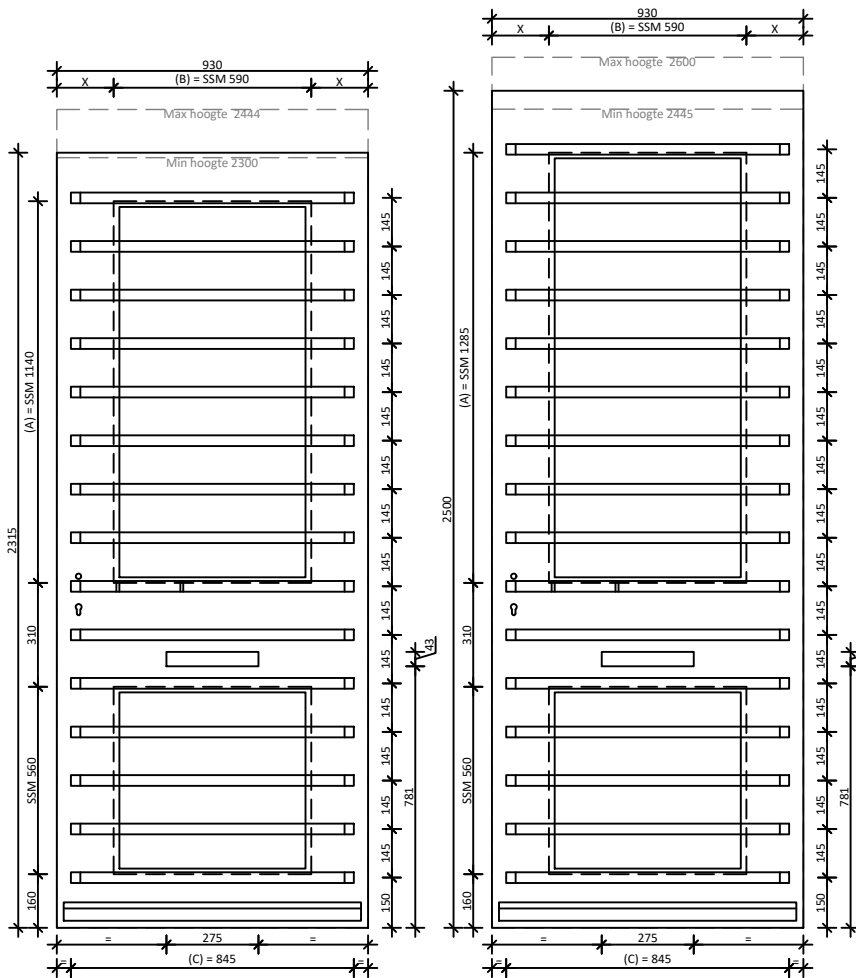
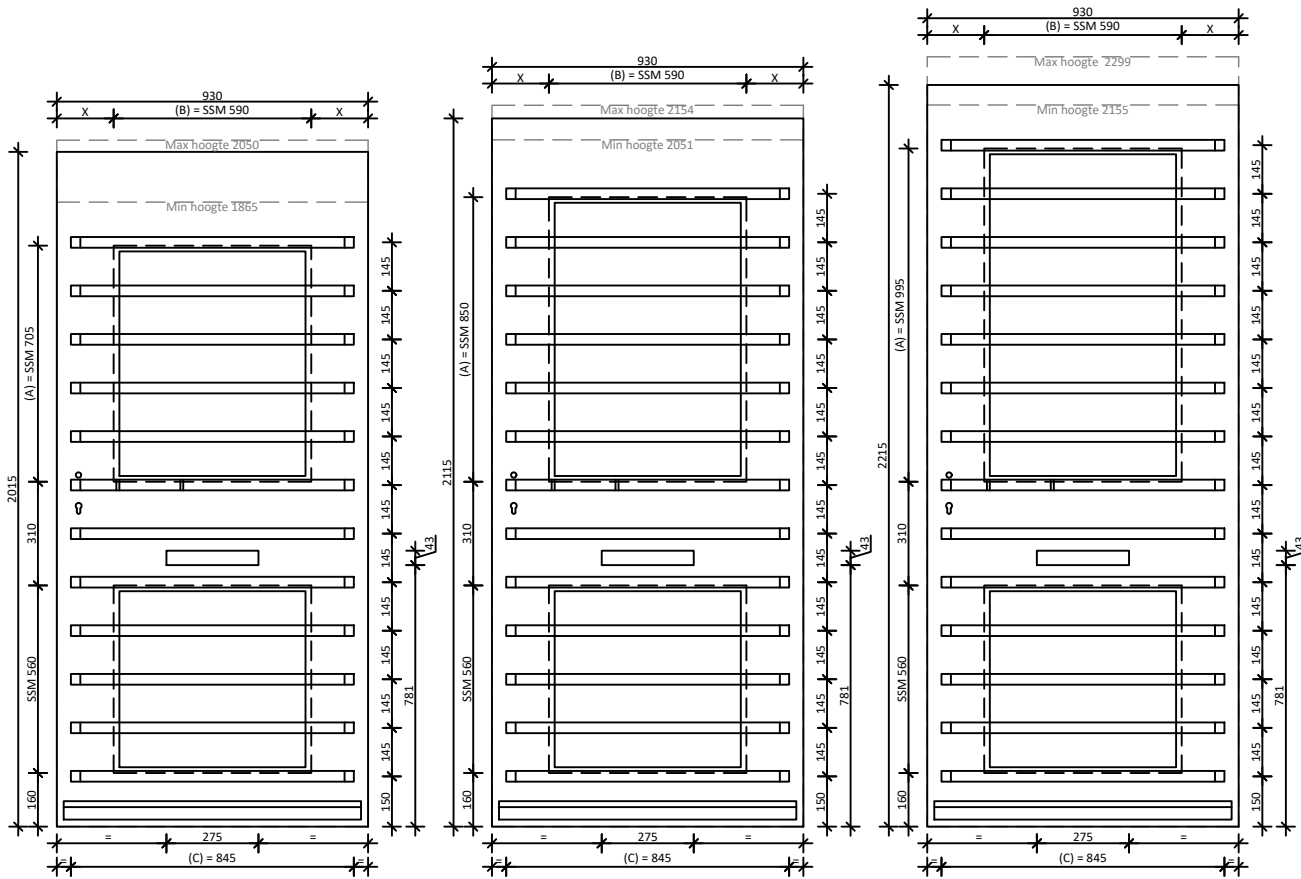

Hoogte staffel			
Deur hoogte min.	max.	aantal latten	(A) SSM hoogte bovenste glasvak
1865	2050	12	705
2051	2154	13	850
2155	2299	14	995
2300	2444	15	1140
2445	2600	16	1285

Breedte staffel 50mm			
Deur breedte min.	max.	(B) SSM breedte glasvakken	(C) Breedte latten
			Enz.
815	864	490	745
865	914	540	795
915	964	590	845
965	1014	640	895
1015	1064	690	945
1065	1114	740	995
1115	1200	790	1045

DATUM: 13-02-2024	GEWIJZIGD:	CALCULATIENR:	TEKENINGNR: 20240213-945-01	MODEL: 94501	HOUTSOORT:
			KLANT/PROJECT: Model 94501 Overzicht		DCM NUMMER:
AANVRAAG:		SCHAAL:	GETEKEND: KF	LEVERWEEK:	

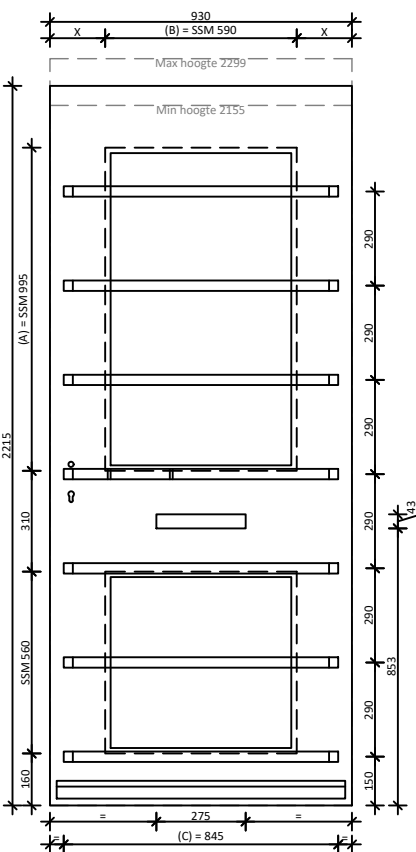
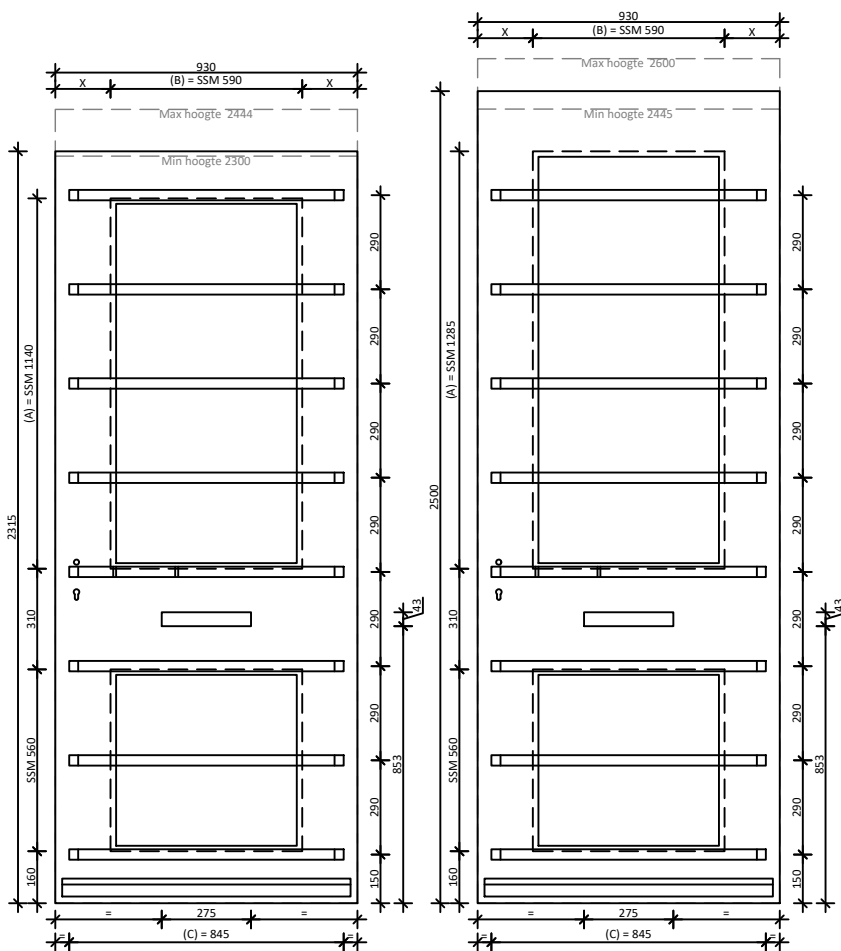
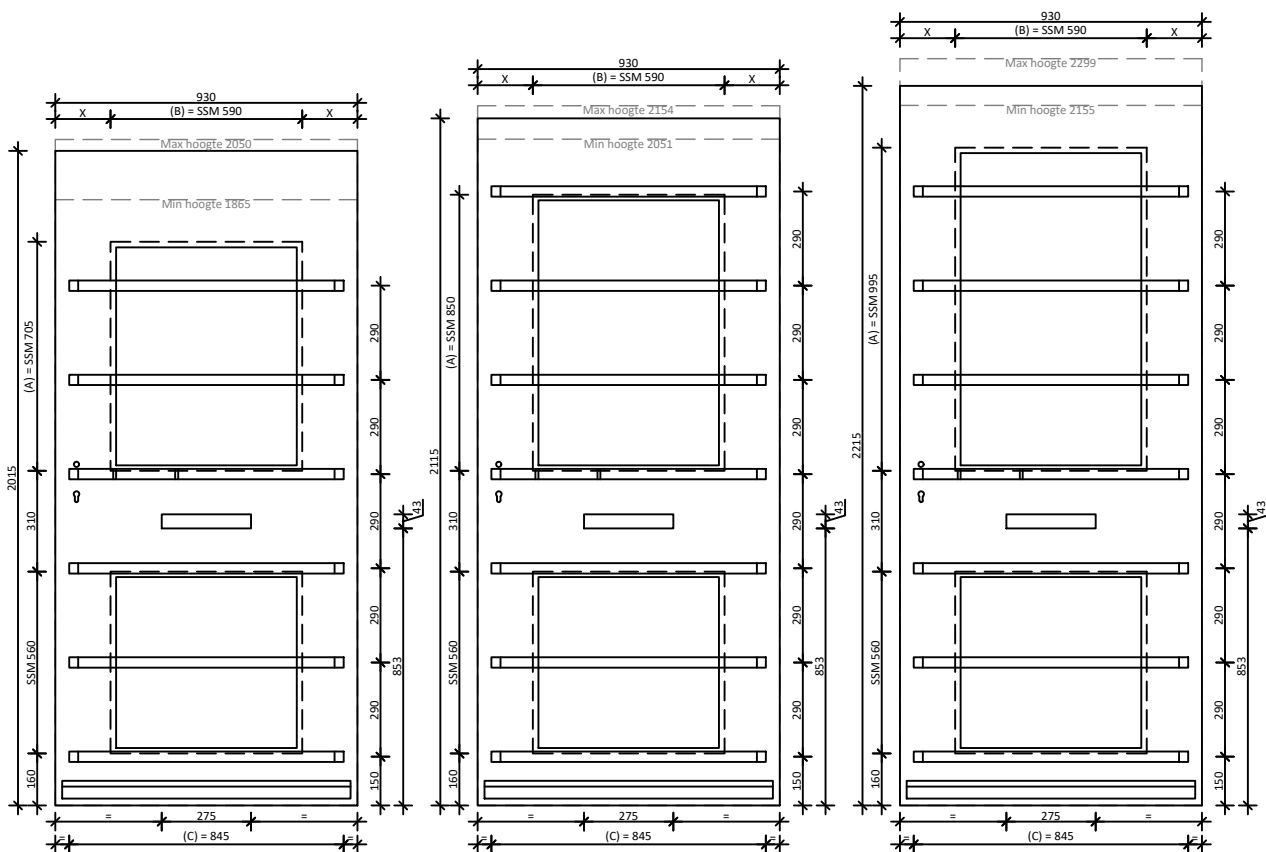

Maten tabel			
Deur hoogte min.	max.	aantal latten	(A) SSM hoogte bovenste glasvak
1865	2050	6	705
2051	2154	7	850
2155	2299	7	995
2300	2444	8	1140
2445	2600	8	1285

Breedte staffel 50mm			
Deur breedte min.	max.	(B) SSM breedte glasvakken	(C) Breedte latten
			Enz.
815	864	490	745
865	914	540	795
915	964	590	845
965	1014	640	895
1015	1064	690	945
1065	1114	740	995
1115	1200	790	1045

DATUM: 13-02-2024 GEWIJZIGD: CALCULATIENR: TEKENINGNR: 20240213-945-01 MODEL: 94502 HOUTSOORT:



KLANT/PROJECT: Model 94502 Overzicht DCM NUMMER:

AANVRAAG: SCHAAL: GETEKEND: KF LEVERWEEK:

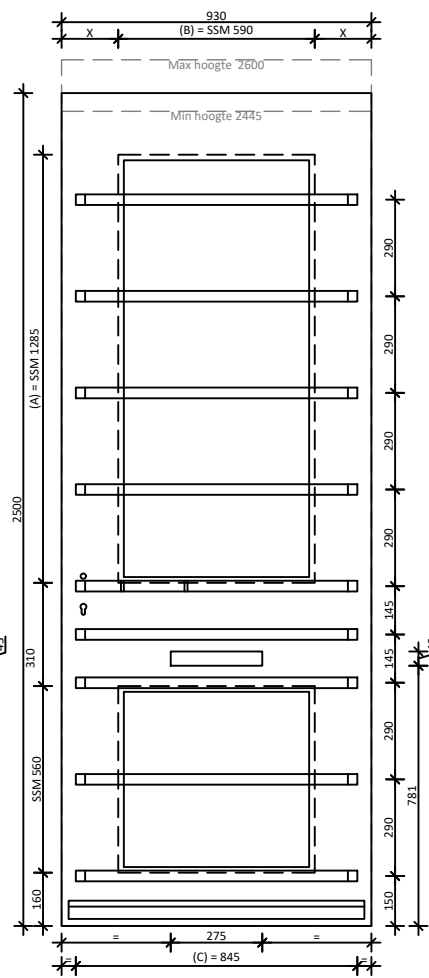
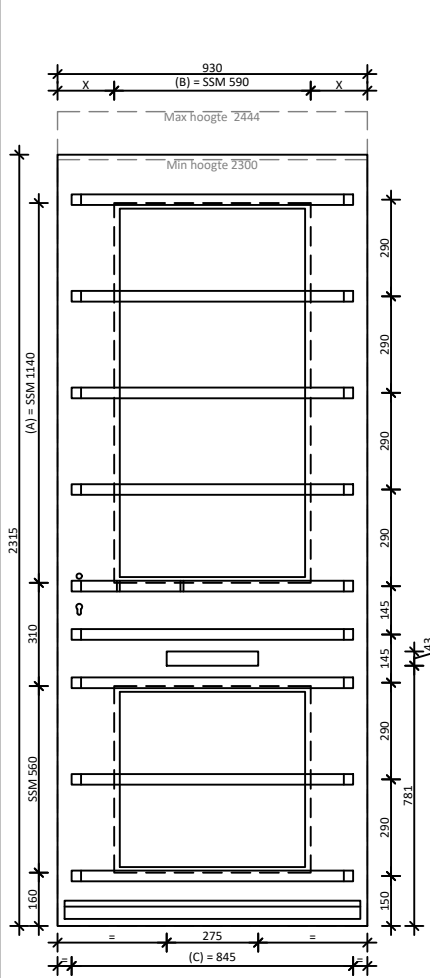
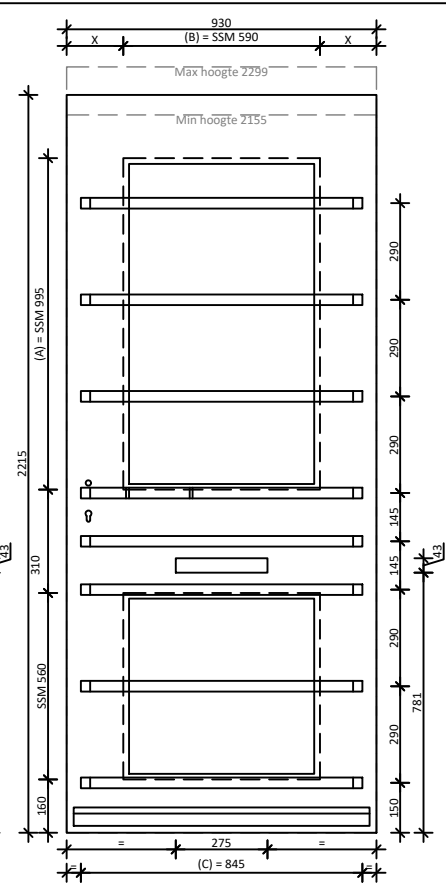
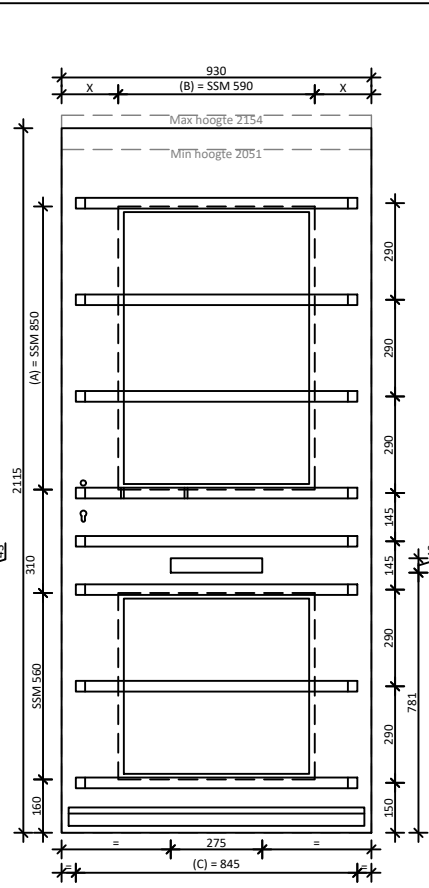
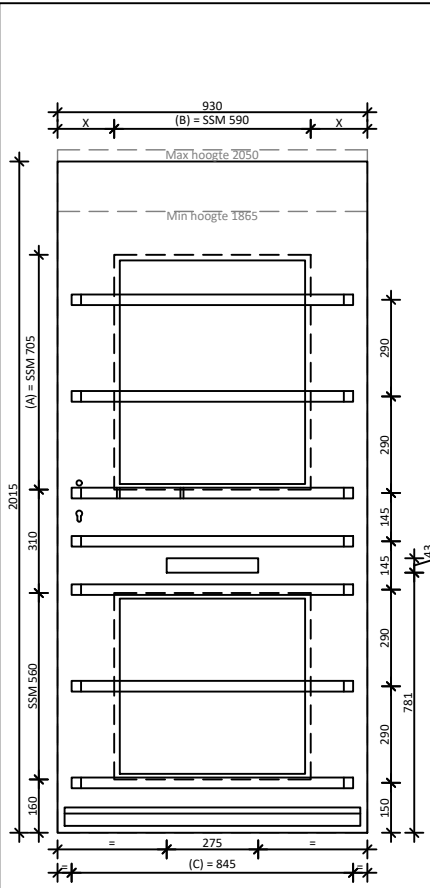

Maten tabel				
Deur hoogte min.	max.	aantal latten	(A) SSM hoogte bovenste glasvak	
1865	2050	6	705	
2051	2154	7	850	
2155	2299	7	995	
2300	2444	8	1140	
2445	2600	8	1285	

Breedte staffel 50mm				
Deur breedte min.	max.	(B) SSM breedte glasvakken	(C) Breedte latten	
			Enz.	
815	864	490	745	
865	914	540	795	
915	964	590	845	
965	1014	640	895	
1015	1064	690	945	
1065	1114	740	995	
1115	1200	790	1045	

DATUM: 13-02-2024	GEWIJZIGD:	CALCULATIENR:	TEKENINGNR: 20240213-945-01	MODEL: 94503	HOUTSOORT:
			KLANT/PROJECT: Model 94503 Overzicht		DCM NUMMER:
			AANVRAAG:	SCHAAL:	GETEKEND: KF

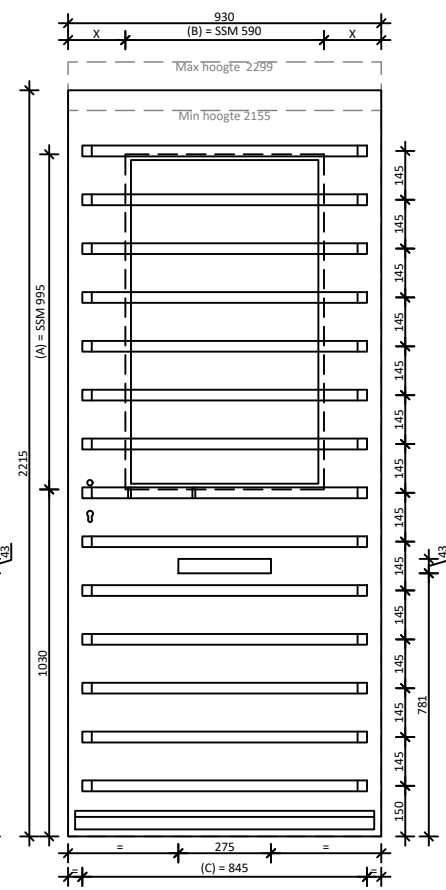
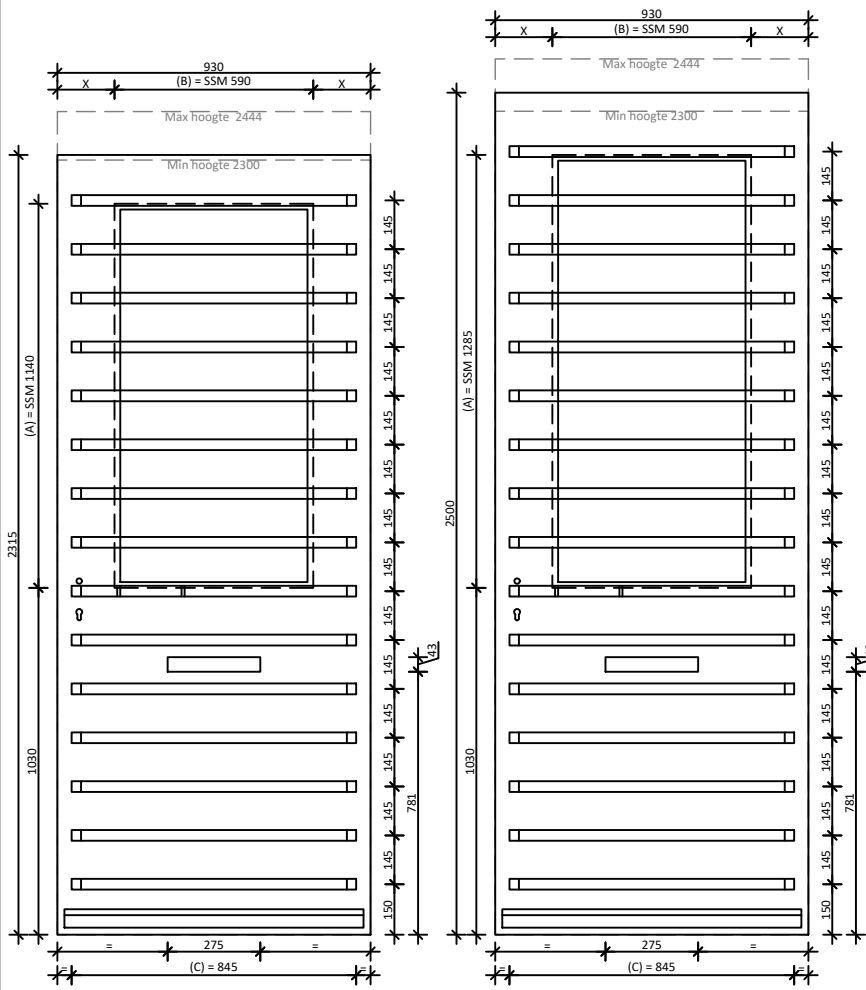
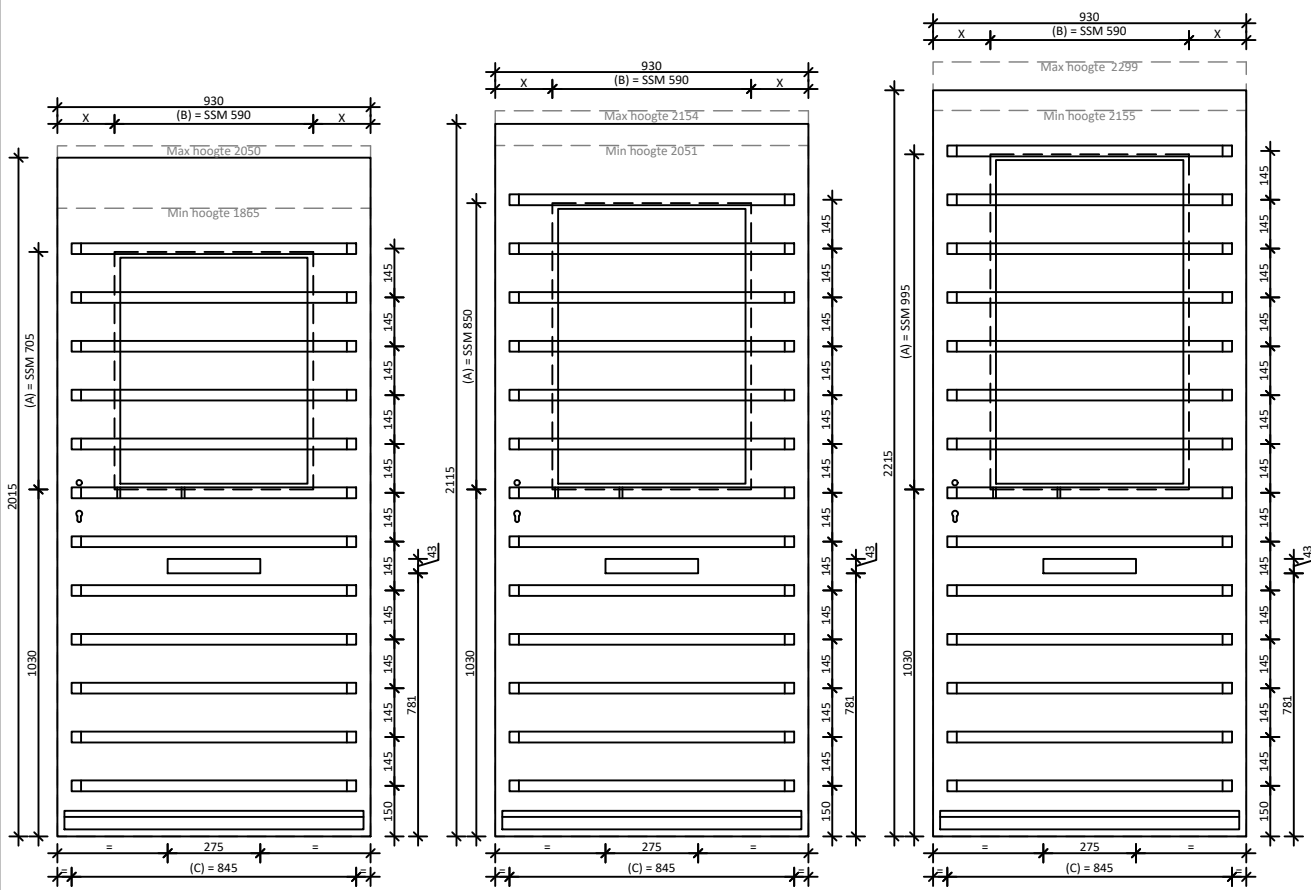

Hoogte staffel				
Deur hoogte min.	max.	aantal latten	(A) SSM hoogte bovenste glasvak	
1865	2050	12	705	
2051	2154	13	850	
2155	2299	14	995	
2300	2444	15	1140	
2445	2600	16	1285	

Breedte staffel 50mm			
Deur breedte min.	max.	(B) SSM breedte glasvakken	(C) Breedte latten
Enz.			
815	864	490	745
865	914	540	795
915	964	590	845
965	1014	640	895
1015	1064	690	945
1065	1114	740	995
1115	1200	790	1045

DATUM: 13-02-2024	GEWIJZIGD:	CALCULATIENR:	TEKENINGNR: 20240213-945-01	MODEL: 94504	HOUTSOORT:
			KLANT/PROJECT: Model 94504 Overzicht		DCM NUMMER:
			AANVRAAG:	SCHAAL:	GETEKEND: KF

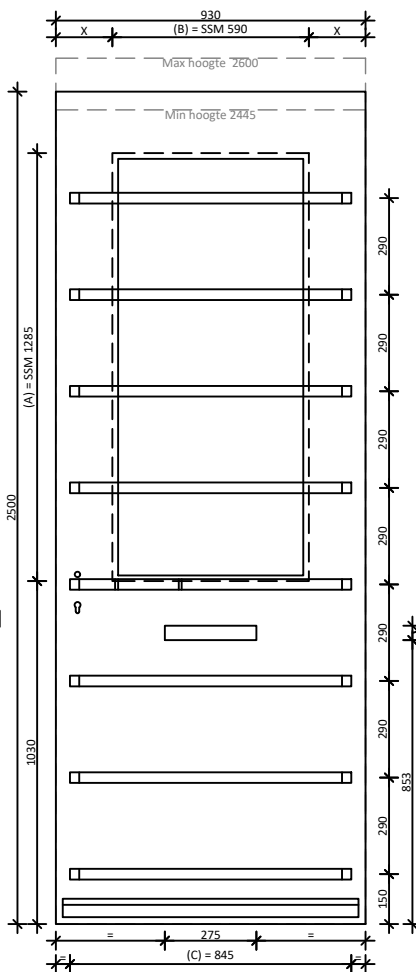
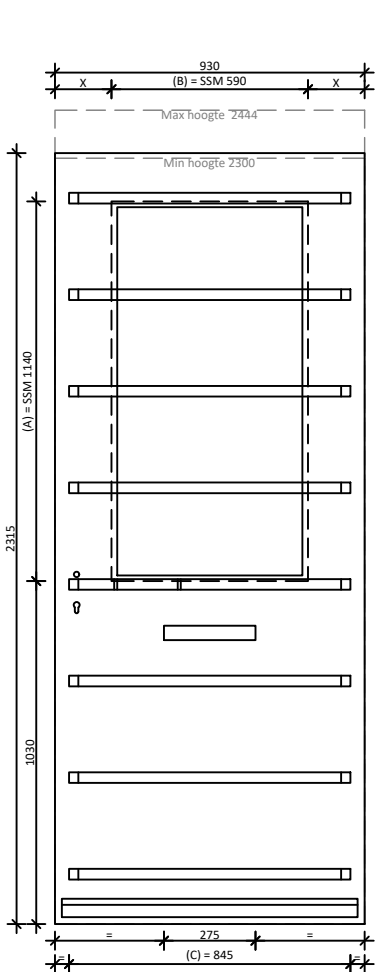
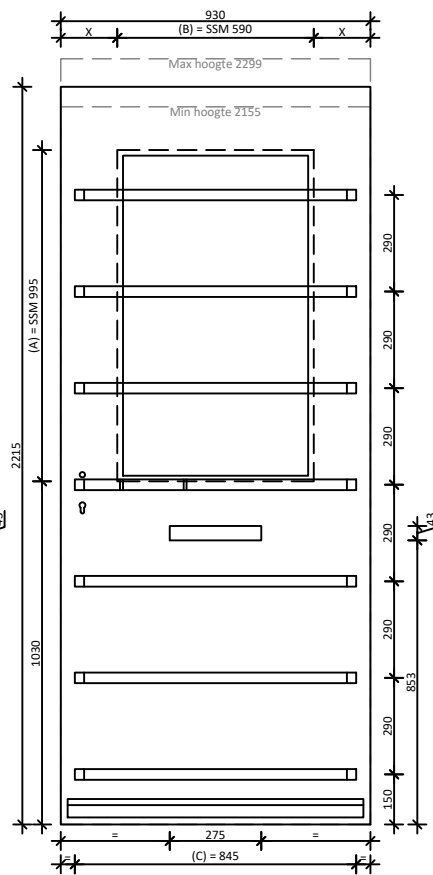
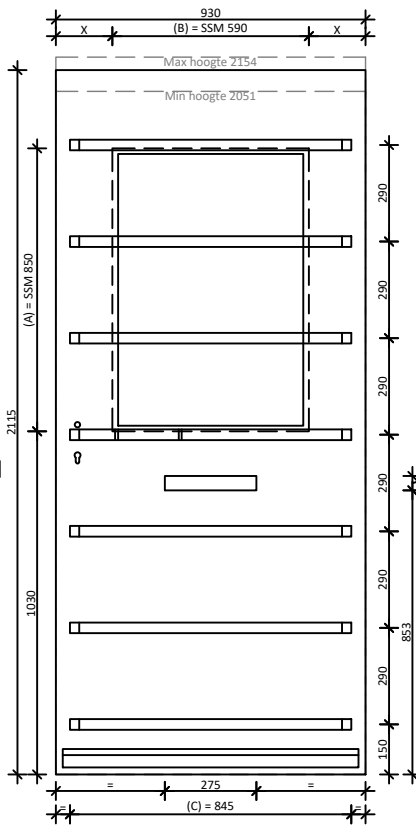
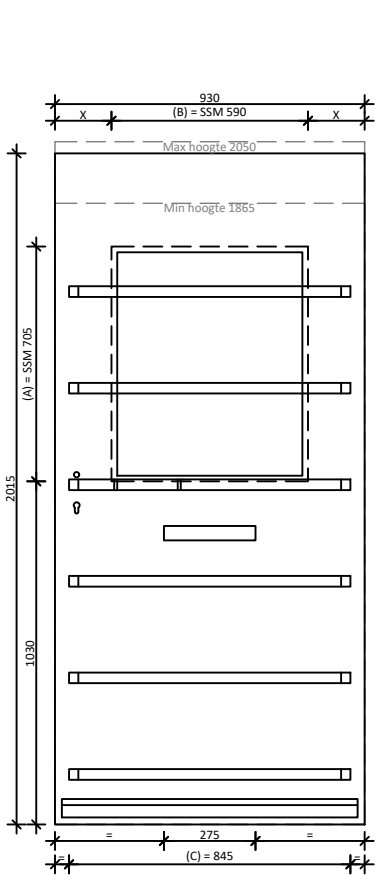

Maten tabel			
Deur hoogte min.	max.	aantal latten	(A) SSM hoogte bovenste glasvak
1865	2050	6	705
2051	2154	7	850
2155	2299	7	995
2300	2444	8	1140
2445	2600	8	1285

Breedte staffel 50mm			
Deur breedte min.	max.	(B) SSM breedte glasvakken	(C) Breedte latten
			Enz.
815	864	490	745
865	914	540	795
915	964	590	845
965	1014	640	895
1015	1064	690	945
1065	1114	740	995
1115	1200	790	1045

DATUM: 13-02-2024 GEWIJZIGD: CALCULATIENR: TEKENINGNR: 20240213-945-01 MODEL: 94505 HOUTSOORT:

KEGRO | DEUREN

KLANT/PROJECT: Model 94505 Overzicht DCM NUMMER:

AANVRAAG: SCHAAL: GETEKEND: KF LEVERWEEK:

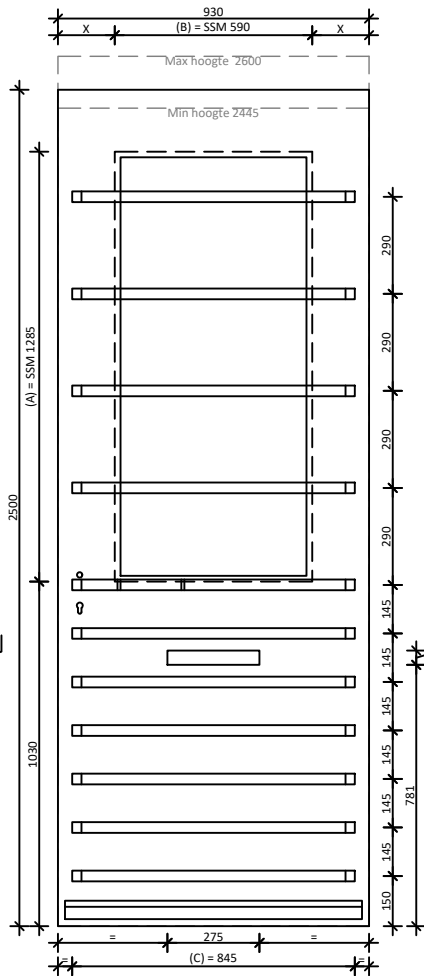
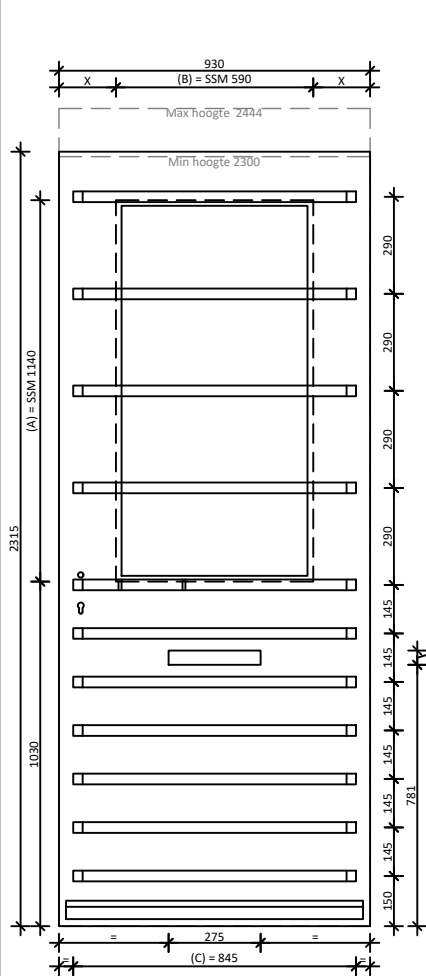
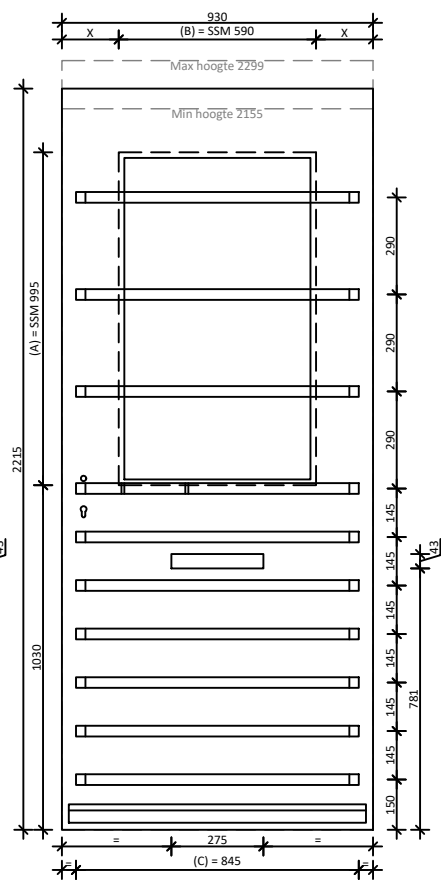
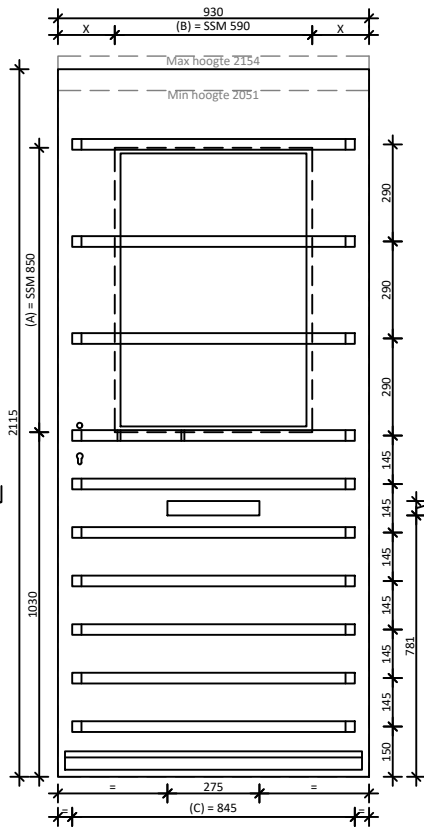
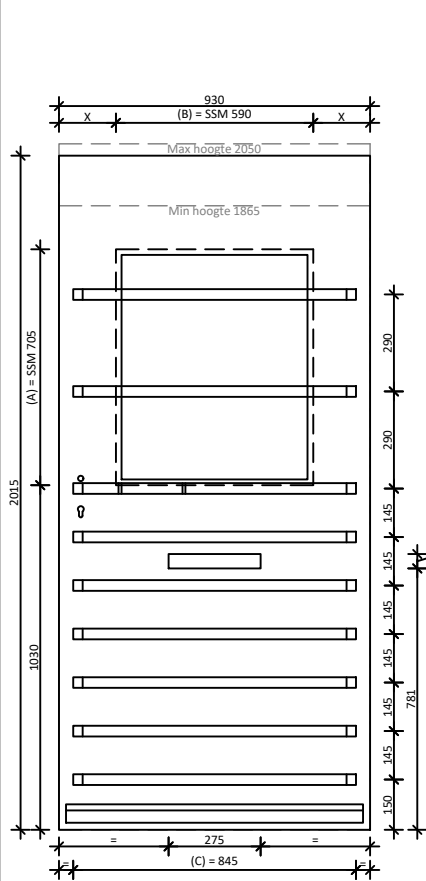

Maten tabel				
Deur hoogte min.	max.	aantal latten	(A) SSM hoogte bovenste glasvak	
1865	2050	6	705	
2051	2154	7	850	
2155	2299	7	995	
2300	2444	8	1140	
2445	2600	8	1285	

Breedte staffel 50mm				
Deur breedte min.	max.	(B) SSM breedte glasvakken	(C) Breedte latten	
			Enz.	
815	864	490	745	
865	914	540	795	
915	964	590	845	
965	1014	640	895	
1015	1064	690	945	
1065	1114	740	995	
1115	1200	790	1045	

DATUM: 13-02-2024	GEWIJZIGD: 14-03-2024	CALCULATIENR:	TEKENINGNR: 20240213-945-01	MODEL: 94506	HOUSOORT:
			KLANT/PROJECT: Model 94506 Overzicht		DCM NUMMER:
			AANVRAAG:	SCHAAL:	GETEKEND: KF

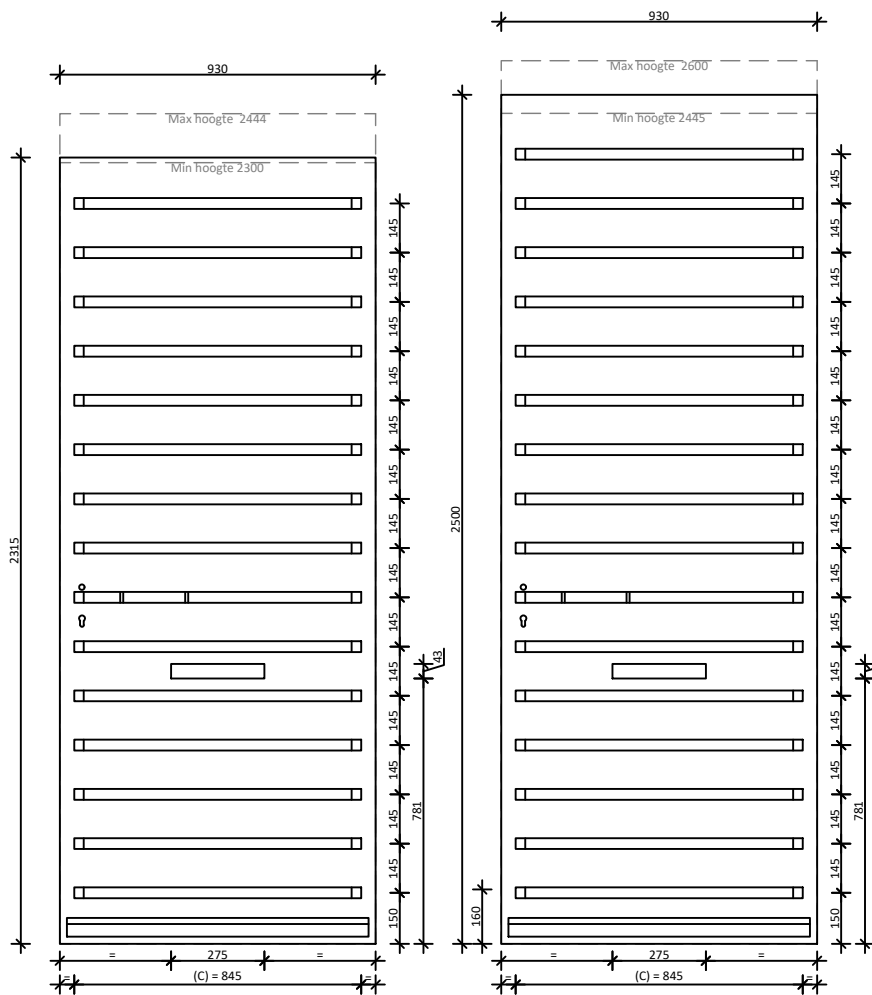
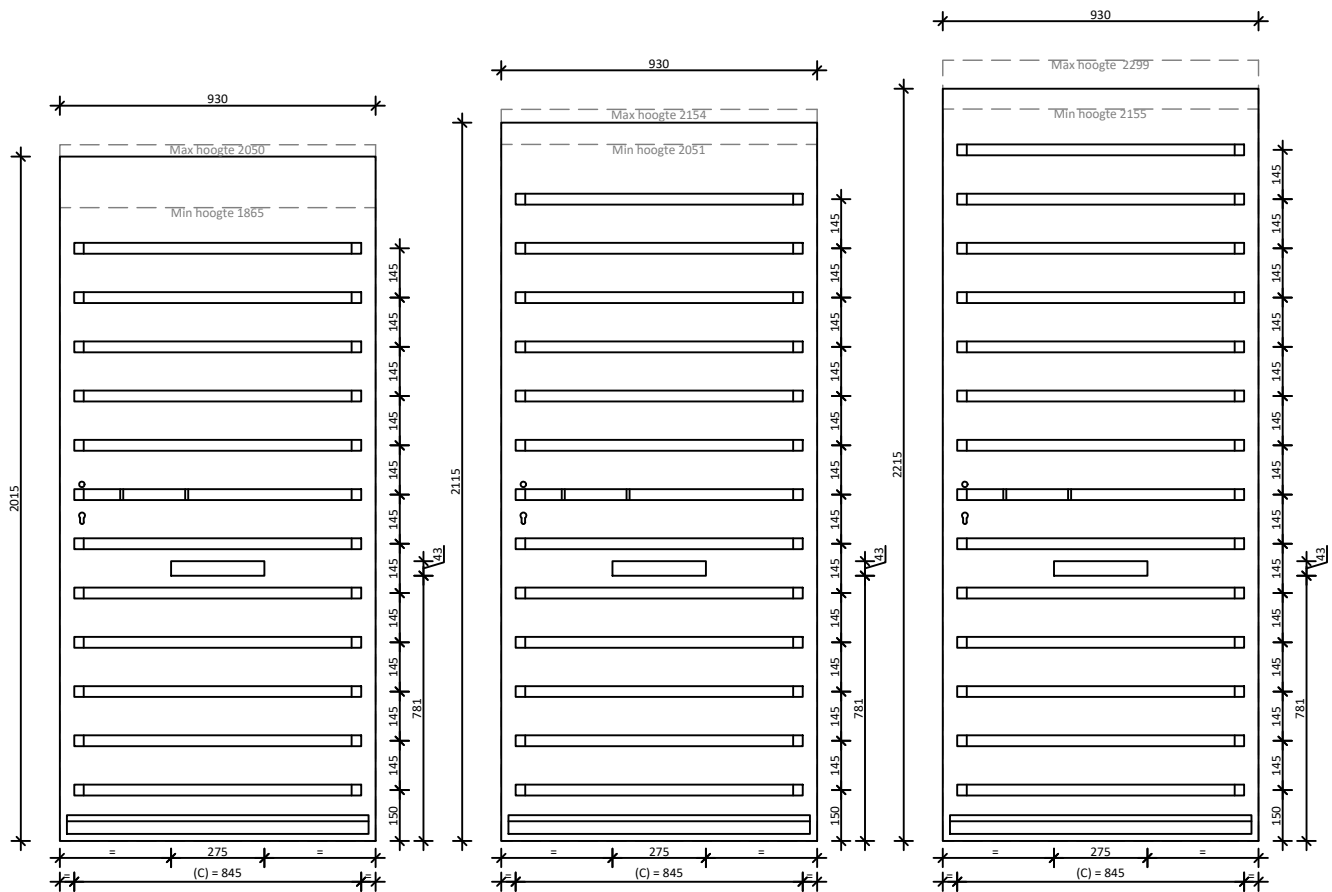

Hoogte staffel		
Deur hoogte min.	max.	aantal latten
1865	2050	12
2051	2154	13
2155	2299	14
2300	2444	15
2445	2600	16

Breedte staffel 50mm		
Deur breedte min.	max.	(C) Breedte latten
		Enz.
815	864	745
865	914	795
915	964	845
965	1014	895
1015	1064	945
1065	1114	995
1115	1200	1045

DATUM: 13-02-2024	GEWIJZIGD:	CALCULATIENR:	TEKENINGNR: 20240213-945-01	MODEL: 94507	HOUSOORT:
			KLANT/PROJECT: Model 94507 Overzicht		DCM NUMMER:
			AANVRAAG:	SCHAAL:	GETEKEND: KF

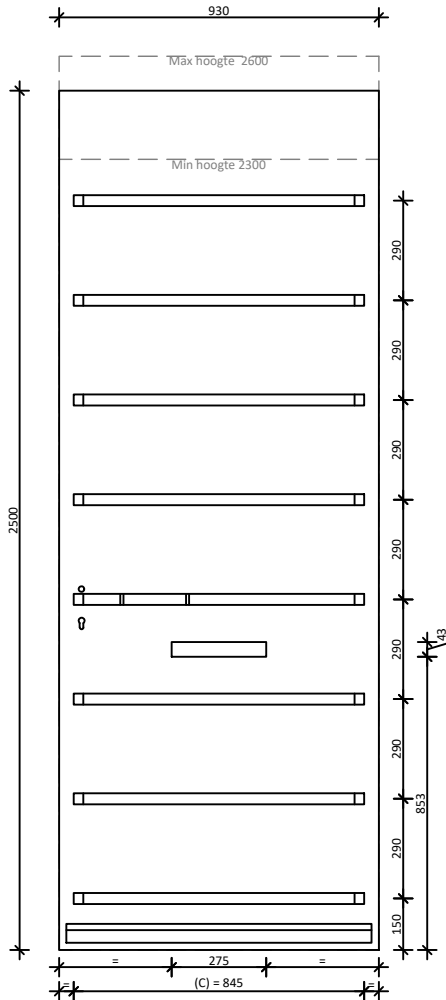
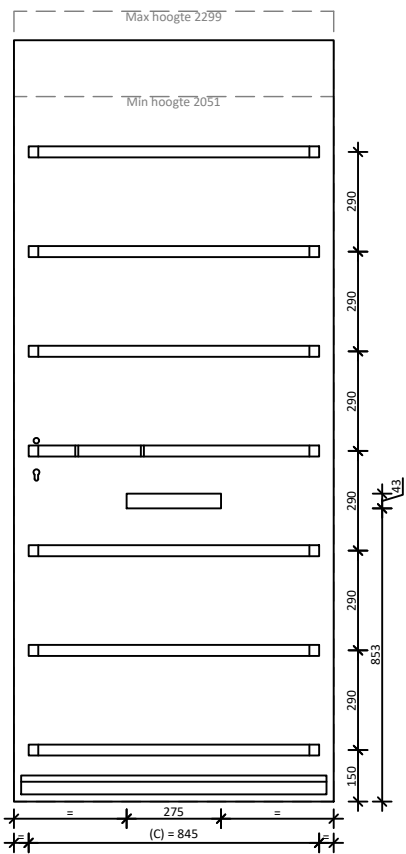
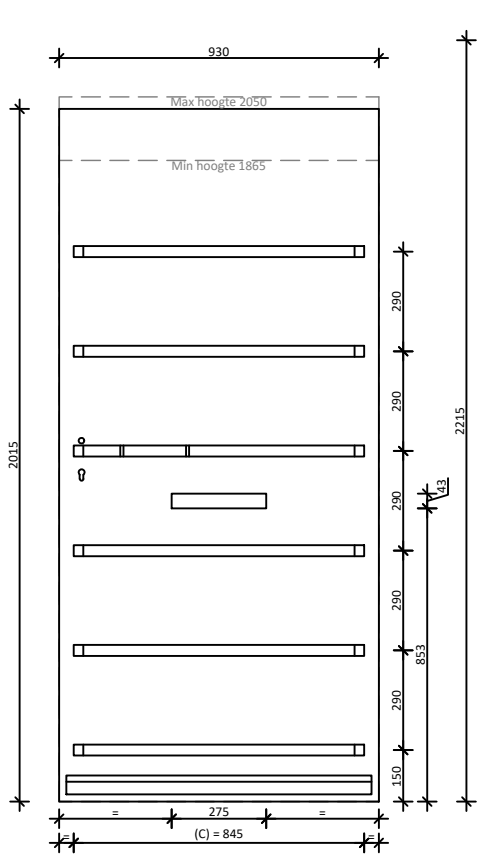

Maten tabel		
Deur hoogte min.	max.	aantal latten
1865	2050	6
2051	2299	7
2300	2600	8

Breedte staffel 50mm		
Deur breedte min.	max.	(C) Breedte latten
		Enz.
815	864	745
865	914	795
915	964	845
965	1014	895
1015	1064	945
1065	1114	995
1115	1200	1045

DATUM: 13-02-2024	GEWIJZIGD:	CALCULATIENR:	TEKENINGNR: 20240213-945-01	MODEL: 94508	HOUTSOORT:
			KLANT/PROJECT: Model 94508 Overzicht		DCM NUMMER:
			AANVRAAG:	SCHAAL:	GETEKEND: KF

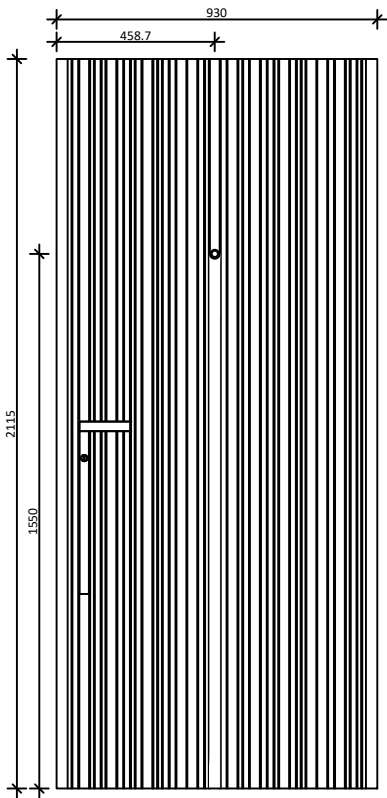

Laag model
1900 - 2200

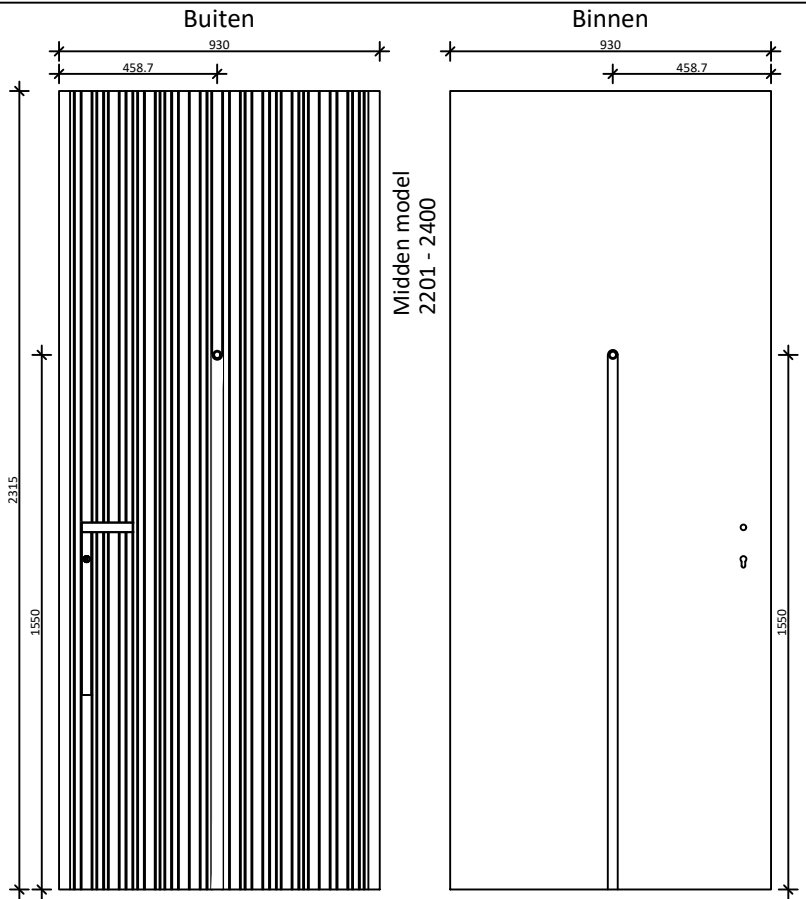

Midden model
2201 - 2400

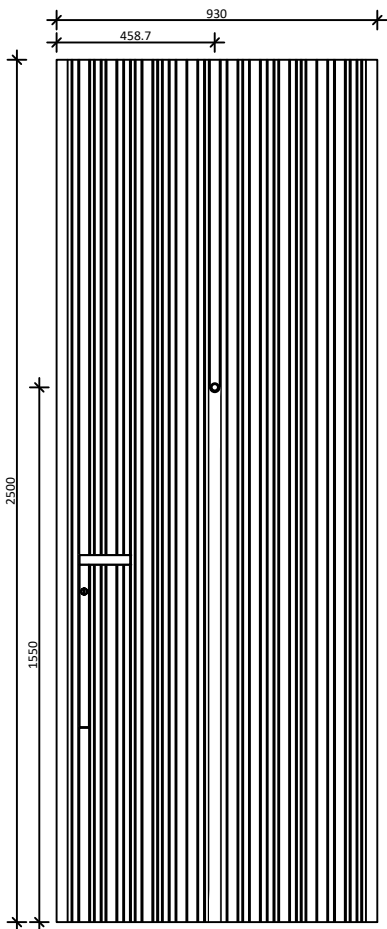

Hoog model
2401 - 2600

DATUM:
16-02-2024

GEWIJZIGD:

CALCULATIENR:

TEKENINGNR:
20240216-942-01

MODEL:
94201

HOUTSOORT:

KEGRO | DEUREN

KLANT/PROJECT:
Model 94201 Overzicht

DCM NUMMER:

AANVRAAG:

SCHAAL:

GETEKEND:
KF

LEVERWEEK:

1.2a P.144

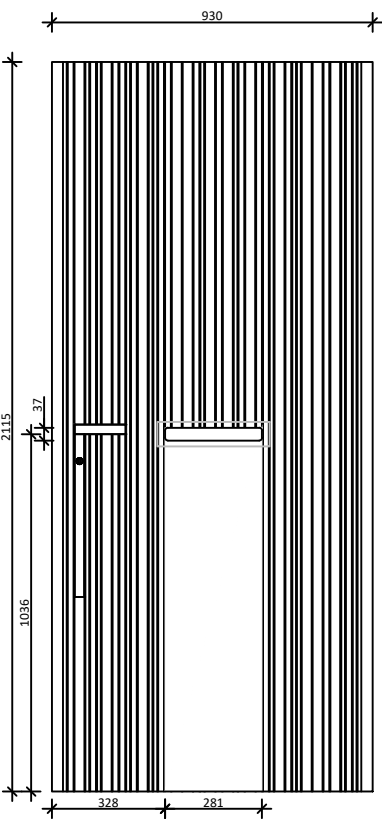

Laag model
1900 - 2200

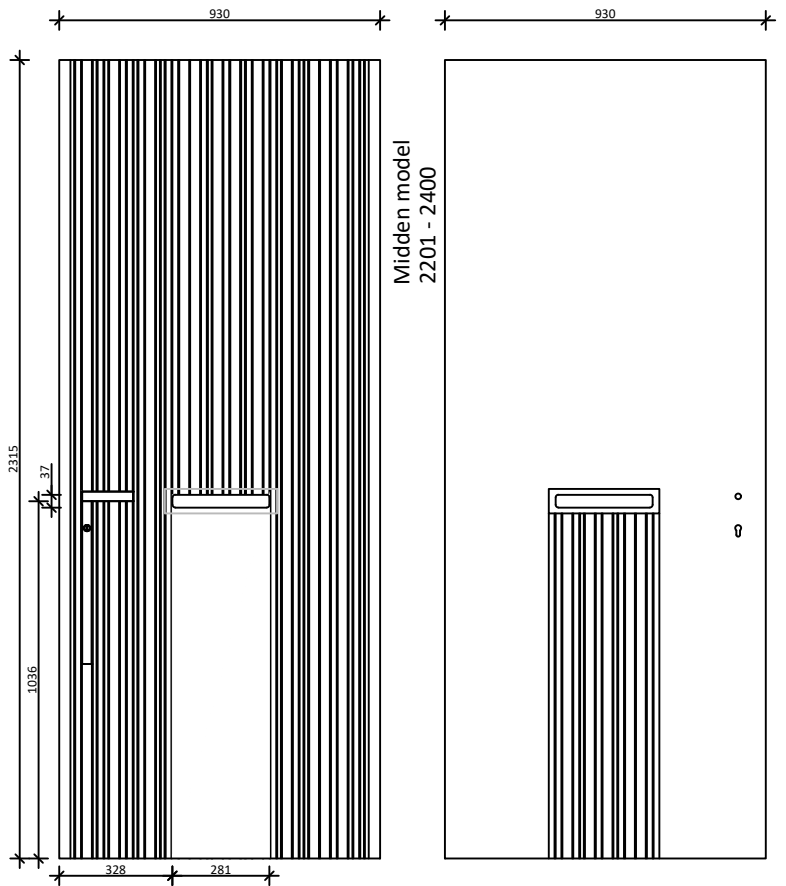

Midden model
2201 - 2400

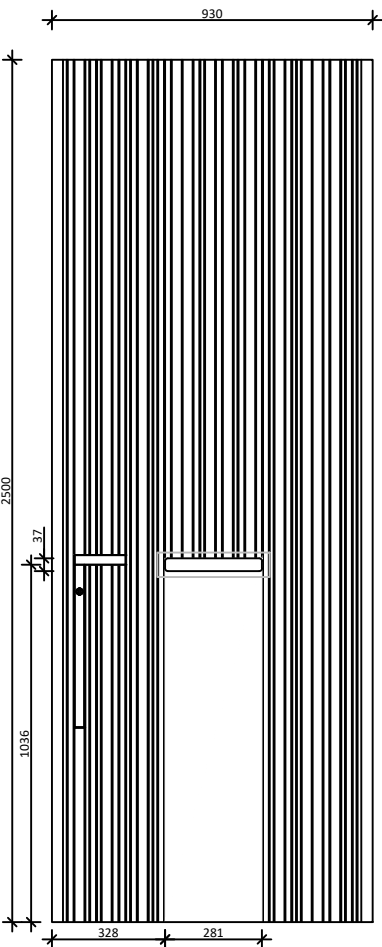

Hoog model
2401 - 2600

DATUM:
16-02-2024

GEWIJZIGD:

CALCULATIENR:

TEKENINGNR:
20240216-942-01

MODEL:
94202

HOUTSOORT:

KEGRO | DEUREN

KLANT/PROJECT:
Model 94202 Overzicht

DCM NUMMER:

AANVRAAG:

SCHAAL:

GETEKEND:
KF

LEVERWEEK:

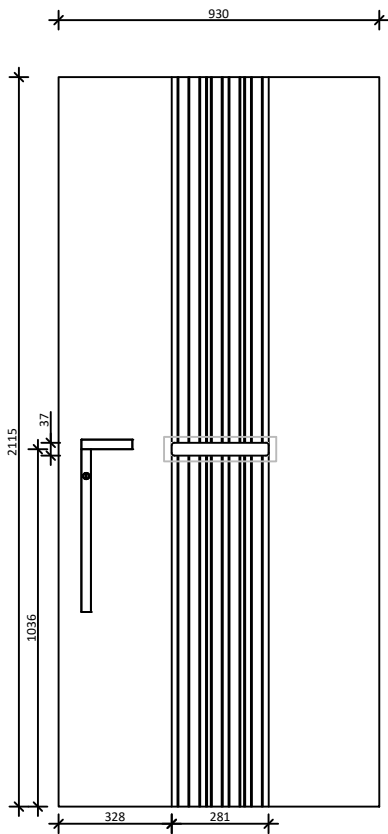

Laag model
1900 - 2200

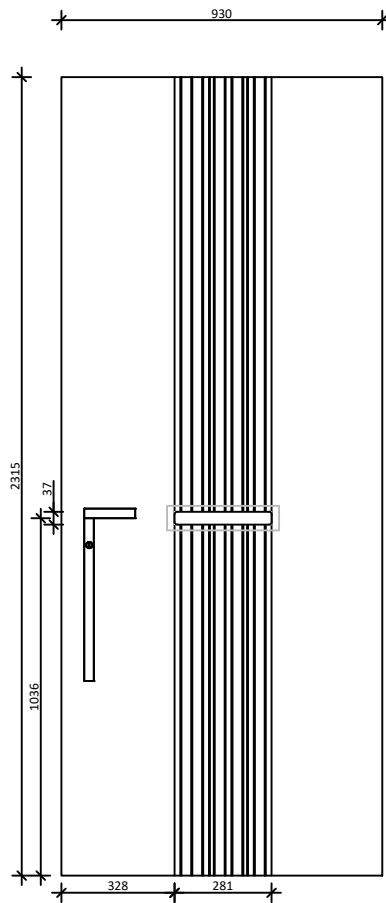

Midden model
2201 - 2400

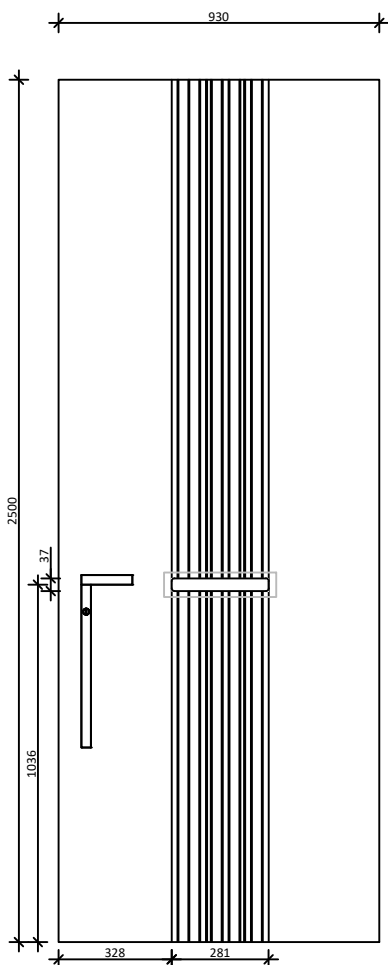

Hoog model
2401 - 2600

DATUM:
16-02-2024

GEWIJZIGD:

CALCULATIENR:

TEKENINGNR:
20240216-942-01

MODEL:
94203

HOUTSOORT:

KEGRO | DEUREN

KLANT/PROJECT:
Model 94203 Overzicht

DCM NUMMER:

AANVRAAG:

SCHAAL:

GETEKEND:
KF

LEVERWEEK:

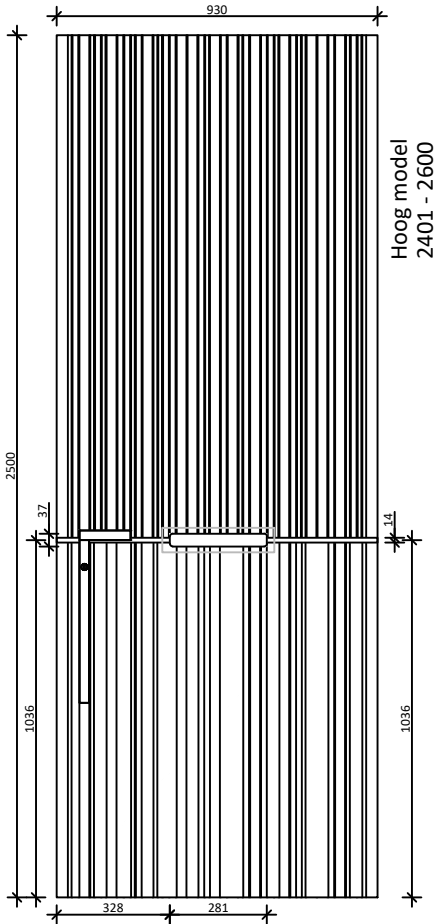
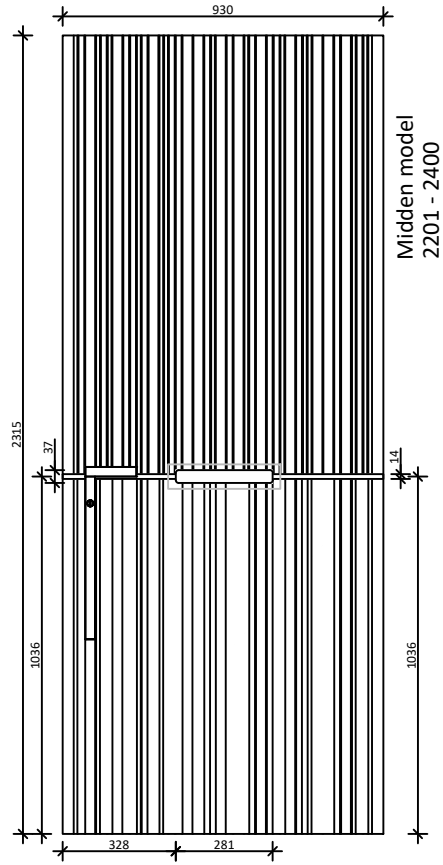
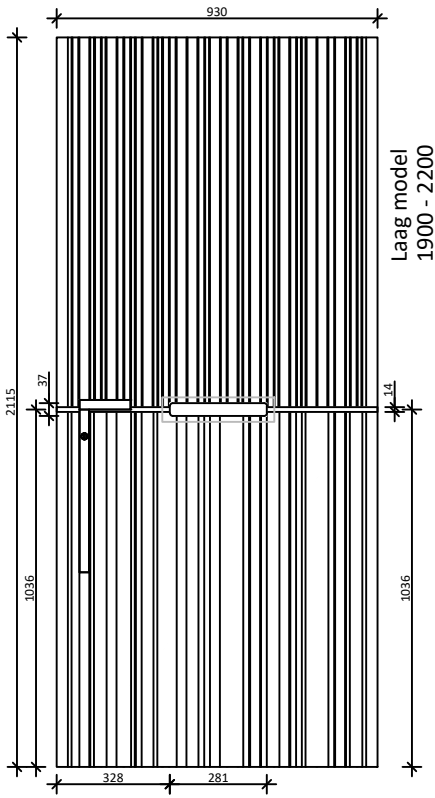

DATUM: 16-02-2024	GEWIJZIGD:	CALCULATIENR:	TEKENINGNR: 20240216-942-01	MODEL: 94204	HOUTSOORT:
			KLANT/PROJECT: Model 94204 Overzicht		DCM NUMMER:
			AANVRAAG:	SCHAAL:	GETEKEND: KF
					1.2a P.147

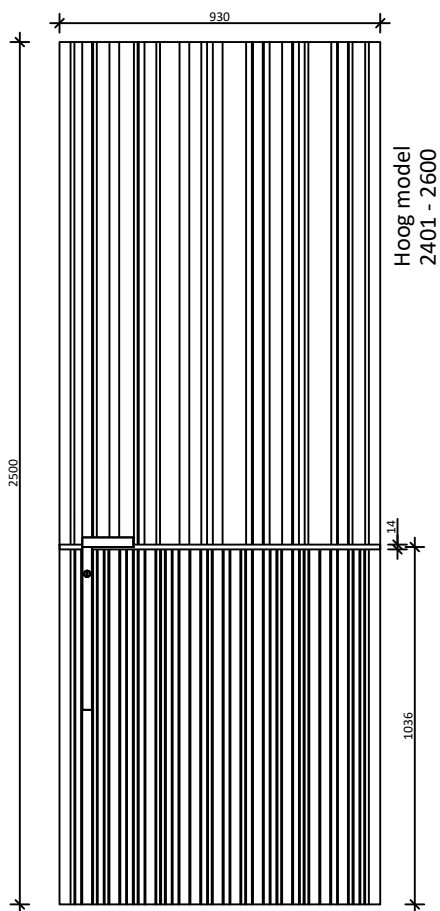
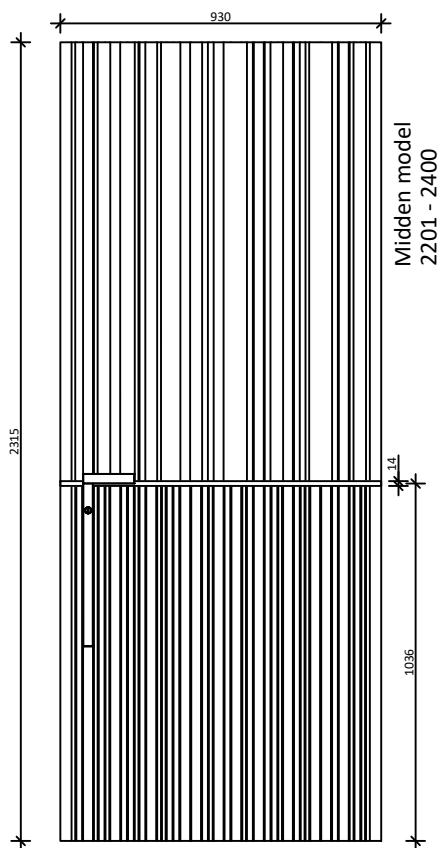
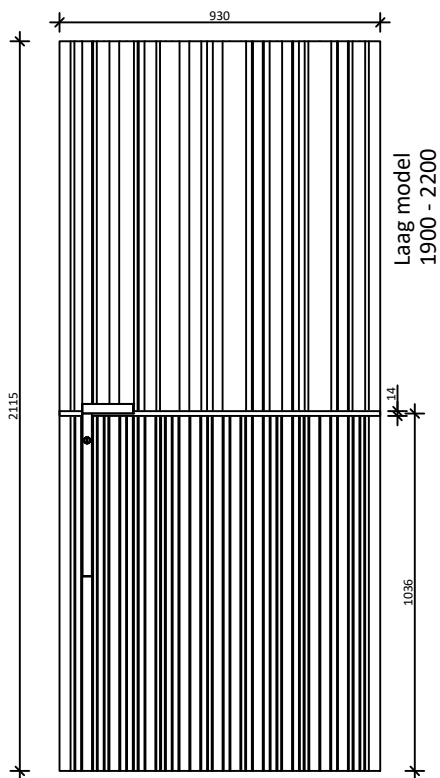

DATUM:
16-02-2024

GEWIJZIGD:

CALCULATIENR:

TEKENINGNR:
20240216-942-01

MODEL:
94205

HOUTSOORT:

KEGRO | **DEUREN**

KLANT/PROJECT:
Model 94205 Overzicht

DCM NUMMER:

AANVRAAG:

SCHAAL:

GETEKEND:
KF

LEVERWEEK:

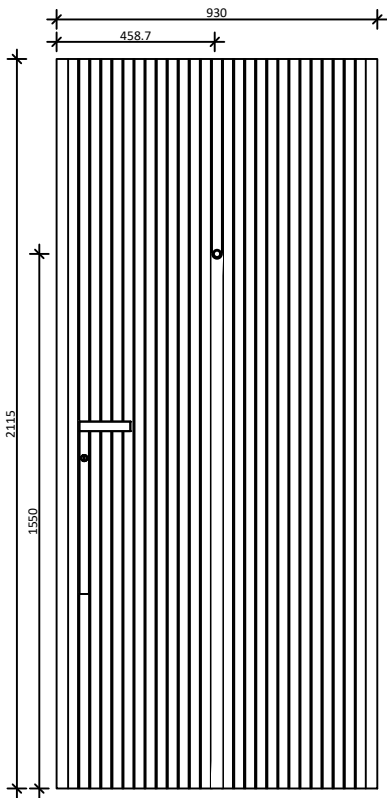

Laag model
1900 - 2200

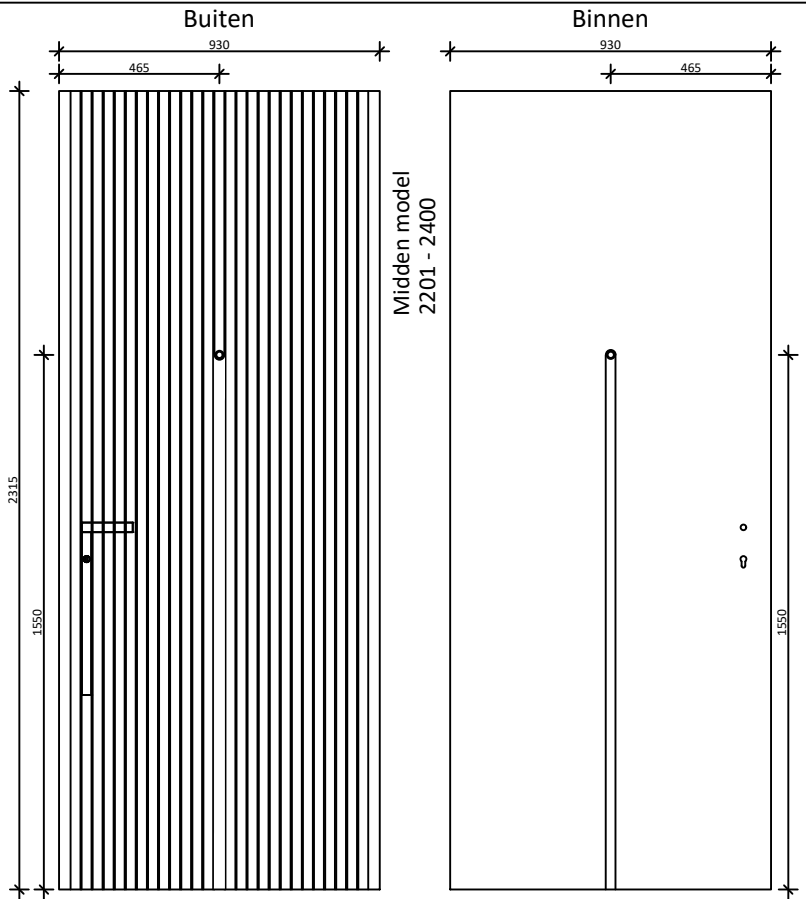

Midden model
2201 - 2400

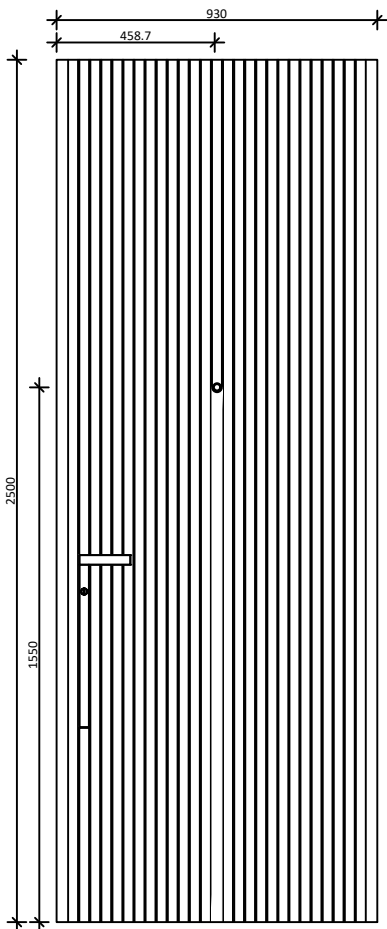

Hoog model
2401 - 2600

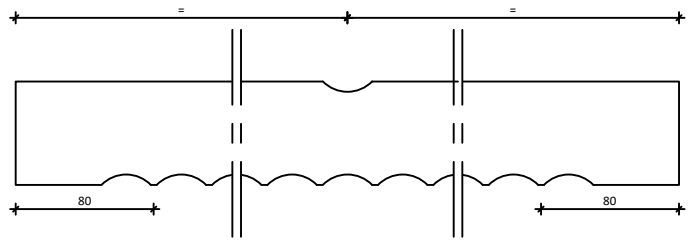

DATUM:
16-02-2024

GEWIJZIGD:

CALCULATIENR:

TEKENINGNR:
20240216-943-01

MODEL:
94301

HOUTSOORT:

KEGRO | DEUREN

KLANT/PROJECT:
Model 94301 Overzicht

DCM NUMMER:

AANVRAAG:

SCHAAL:

GETEKEND:
KF

LEVERWEEK:

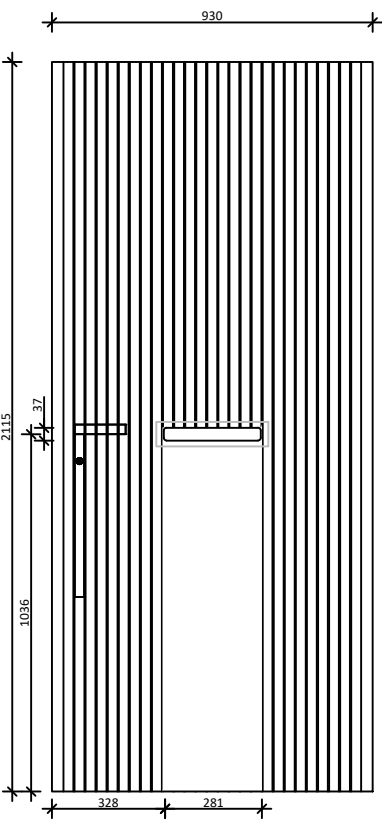

Laag model
1900 - 2200

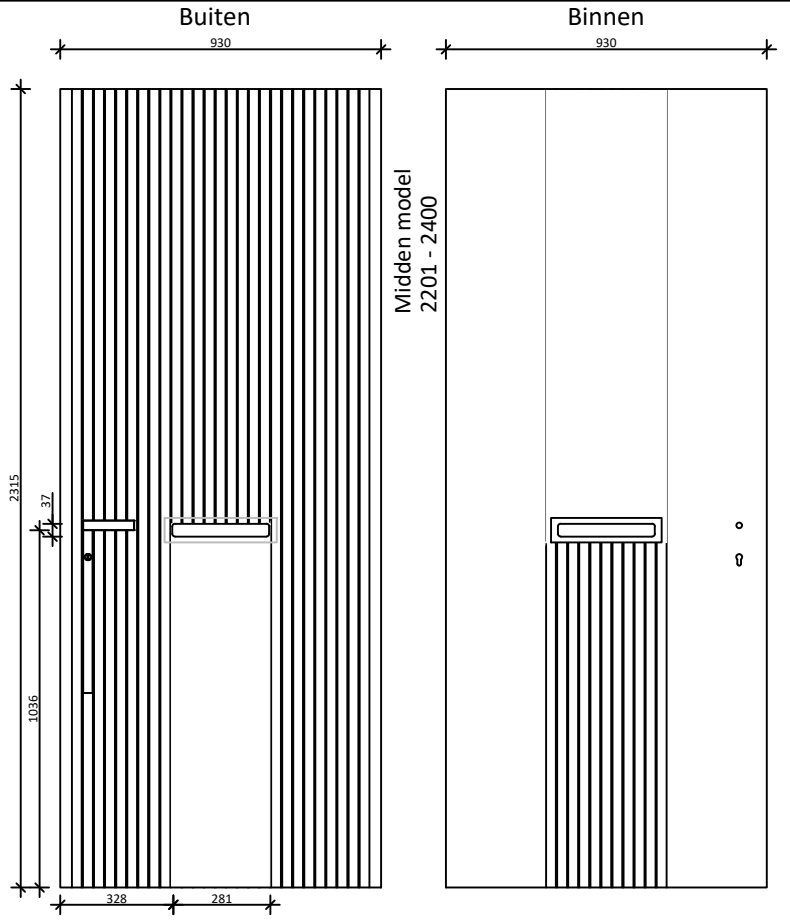

Midden model
2201 - 2400

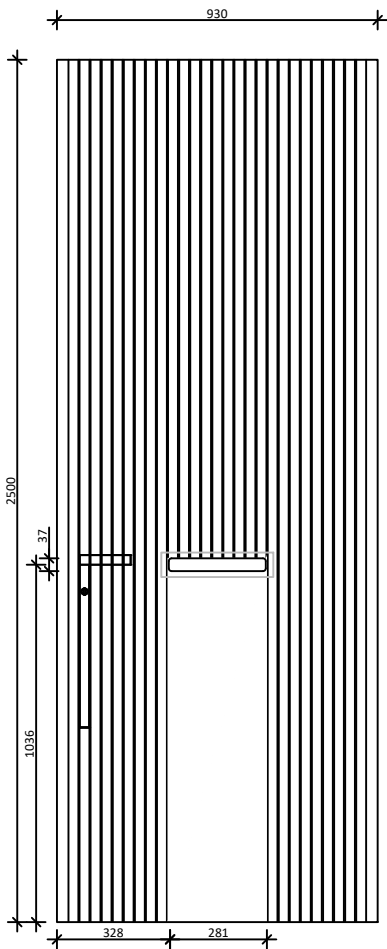

Hoog model
2401 - 2600

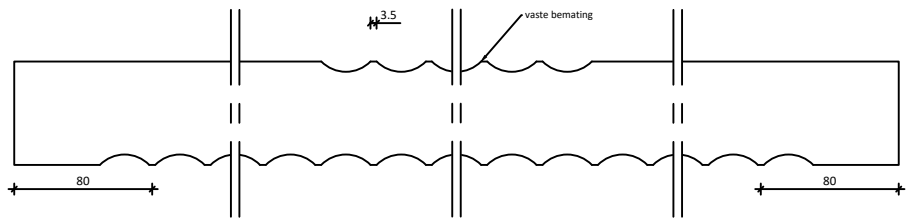

DATUM:
16-02-2024

GEWIJZIGD:

CALCULATIENR:

TEKENINGNR:
20240216-943-01

MODEL:
94302

HOUTSOORT:

KEGRO | DEUREN

KLANT/PROJECT:
Model 94302 Overzicht

DCM NUMMER:

AANVRAAG:

SCHAAL:

GETEKEND:
KF

LEVERWEEK:

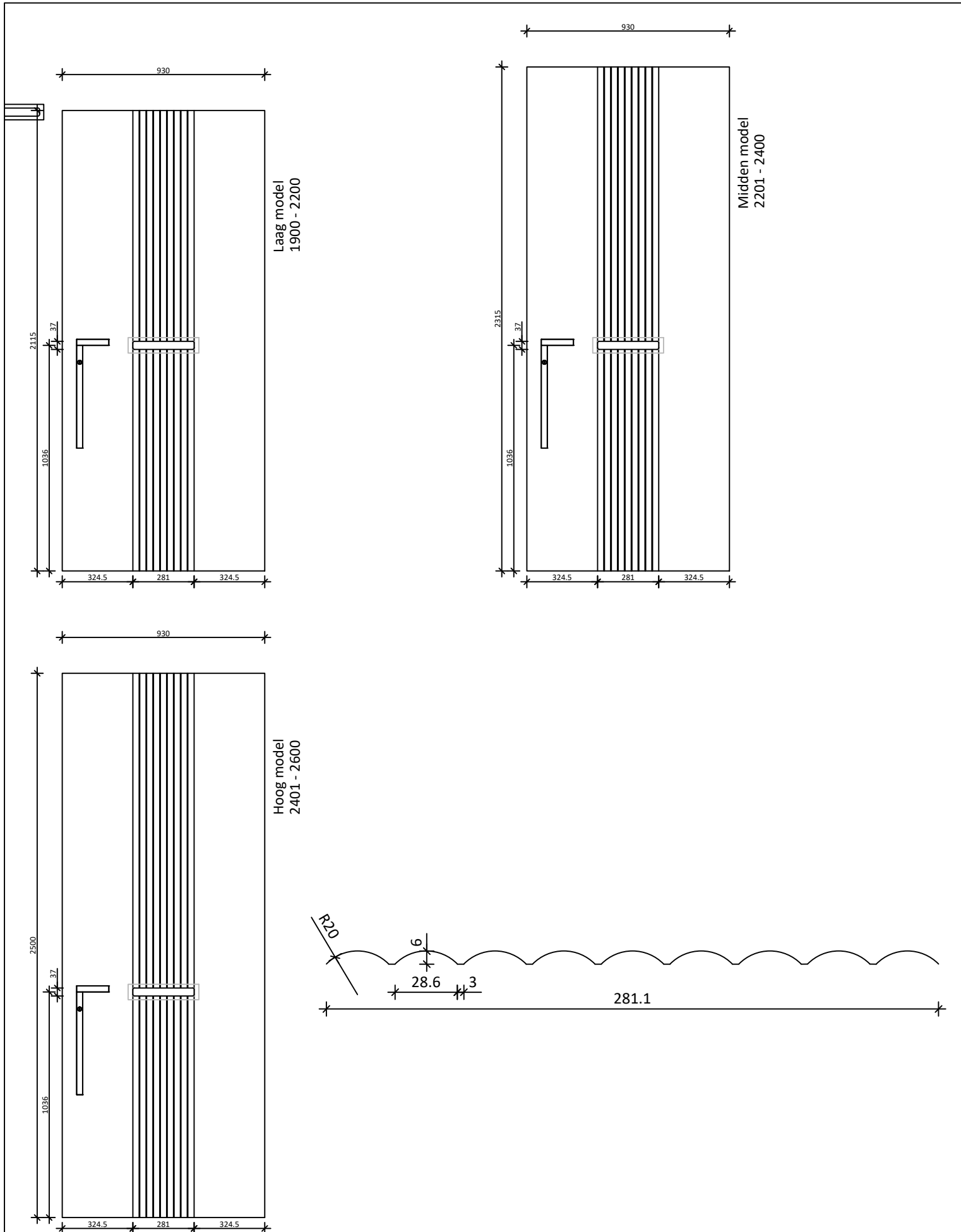

DATUM: 16-02-2024	GEWIJZIGD:	CALCULATIENR:	TEKENINGNR: 20240216-943-01	MODEL: 94303	HOUTSOORT:
			KLANT/PROJECT: Model 94303 Overzicht		DCM NUMMER:
			AANVRAAG:	SCHAAL:	GETEKEND: KF
					1.2a P.151

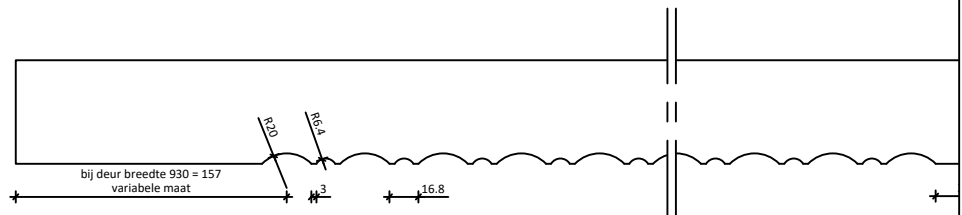
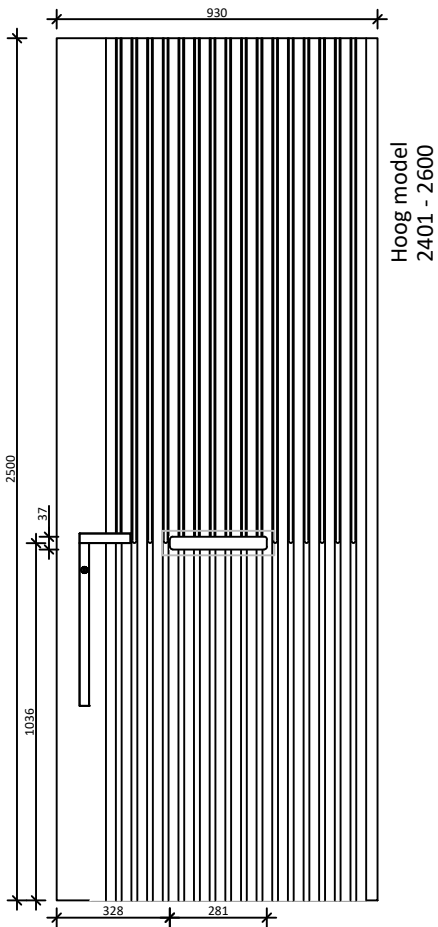
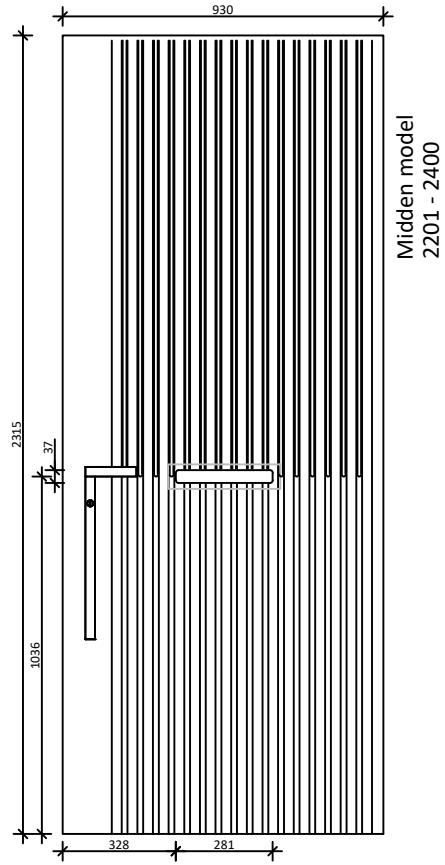
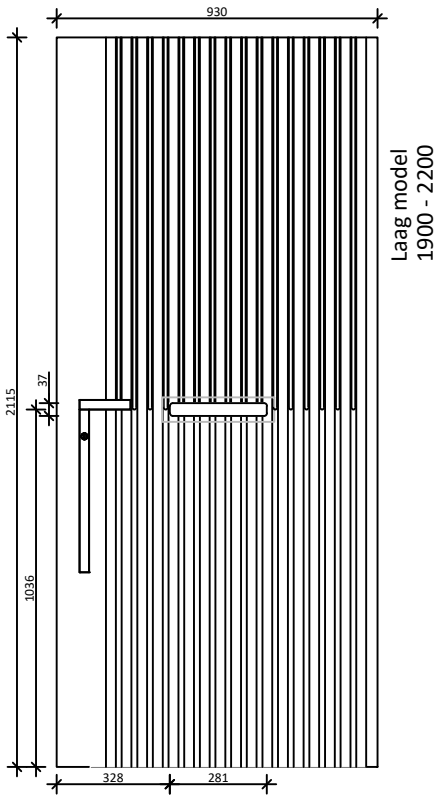

DATUM:
16-02-2024

GEWIJZIGD:

CALCULATIENR:

TEKENINGNR:
20240216-943-01

MODEL:
94304

HOUTSOORT:

KEGRO | DEUREN

KLANT/PROJECT:
Model 94304 Overzicht

DCM NUMMER:

AANVRAAG:

SCHAAL:

GETEKEND:
KF

LEVERWEEK:

1.2a P.152

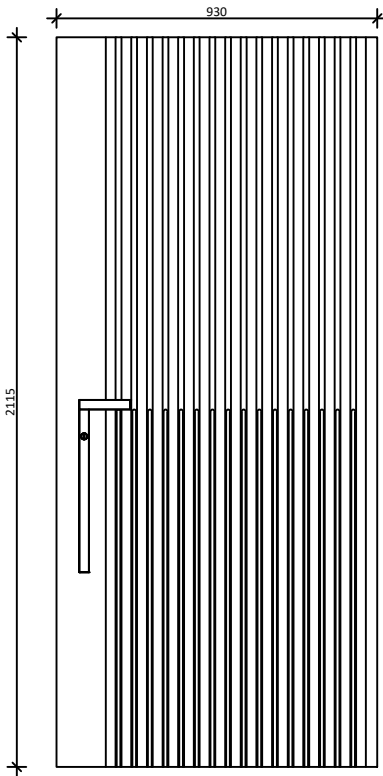

Laag model
1900 - 2200

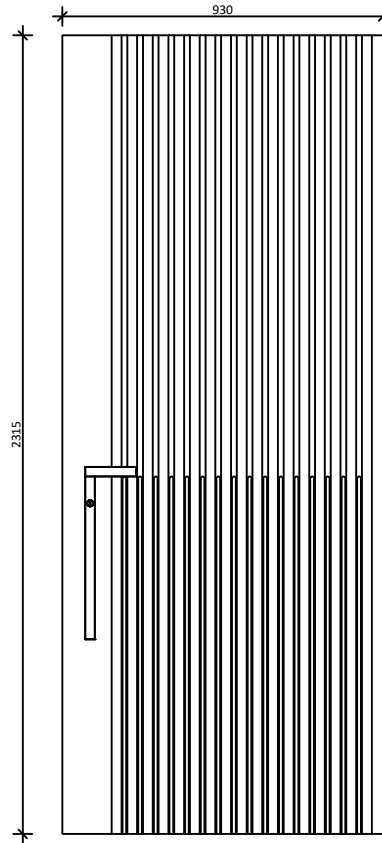

Midden model
2201 - 2400

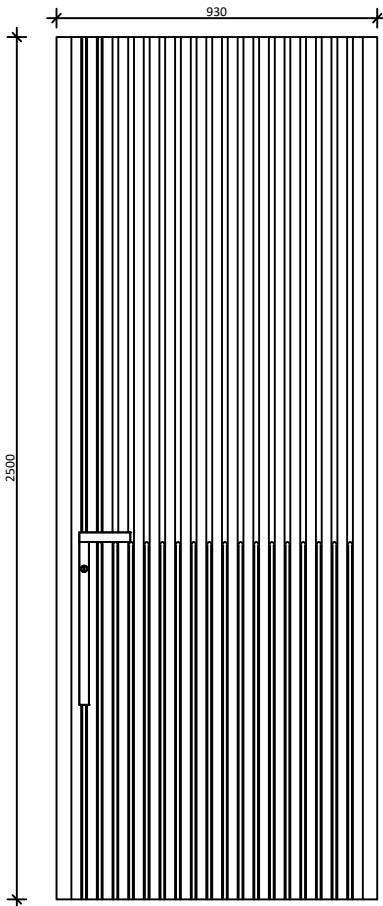

Hoog model
2401 - 2600

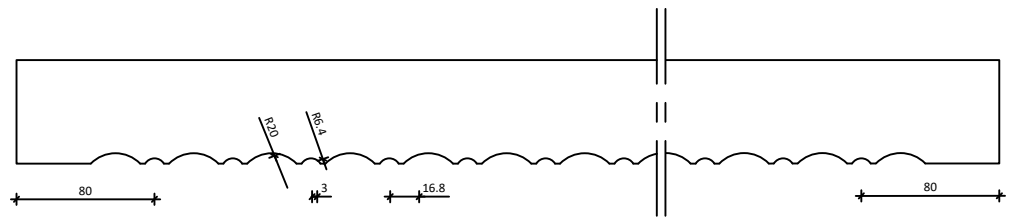

DATUM:
16-02-2024

GEWIJZIGD:

CALCULATIENR:

TEKENINGNR:
20240216-943-01

MODEL:
94305

HOUTSOORT:

KEGRO | **DEUREN**

KLANT/PROJECT:
Model 94305 Overzicht

DCM NUMMER:

AANVRAAG:

SCHAAL:

GETEKEND:
KF

LEVERWEEK:

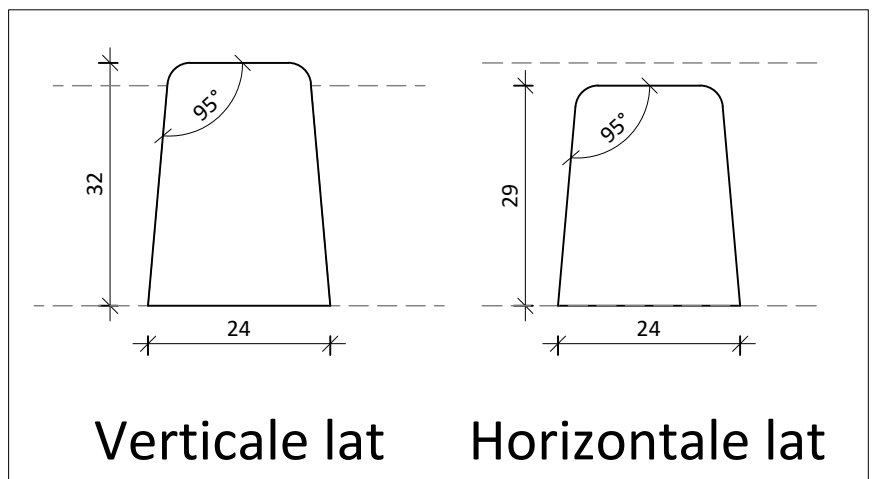
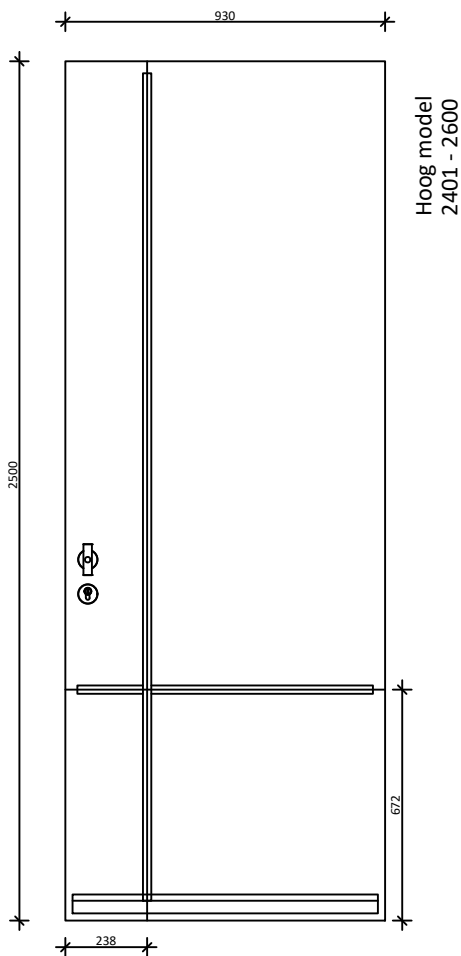
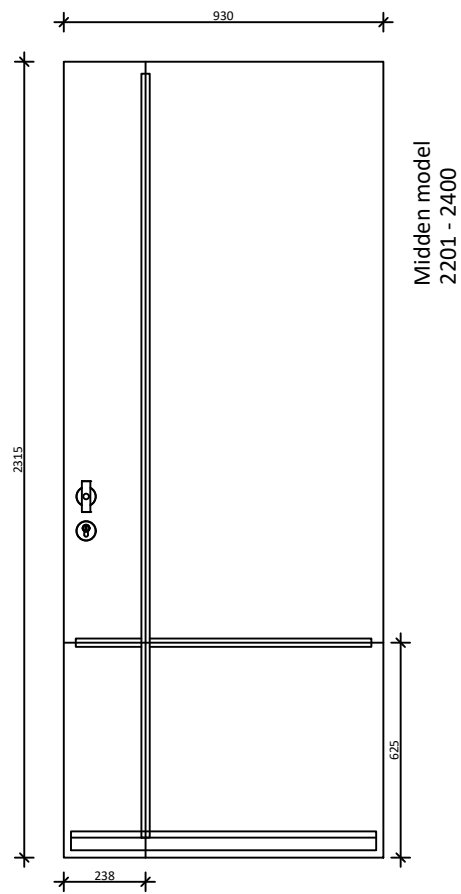
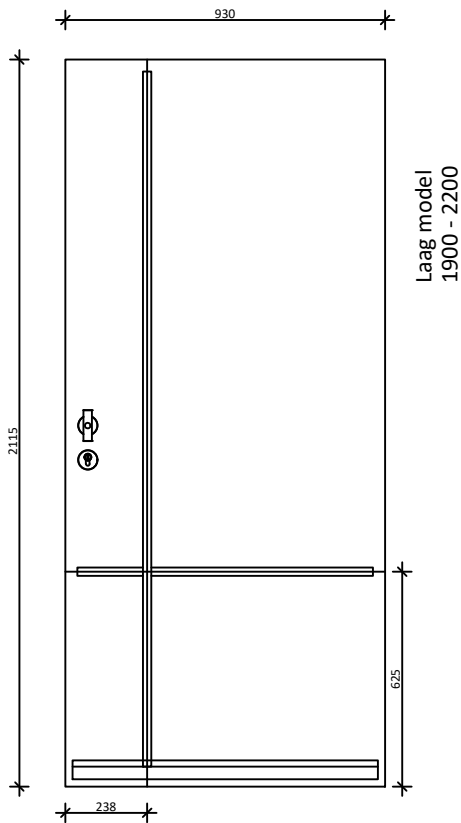

DATUM: 20-02-2024	GEWIJZIGD:	CALCULATIENR:	TEKENINGNR: 20240220-948-01	MODEL: 94801	HOUTSOORT:
			KLANT/PROJECT: Model 94801 Overzicht		DCM NUMMER:
			AANVRAAG:	SCHAAL:	GETEKEND: KF

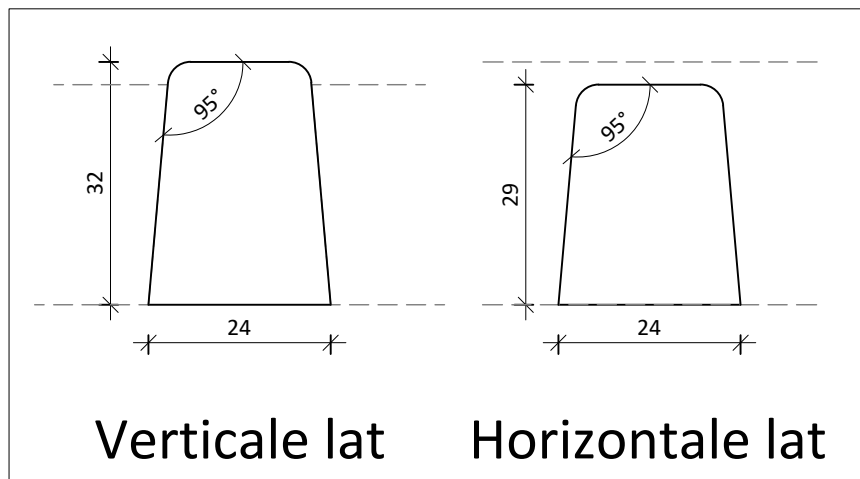
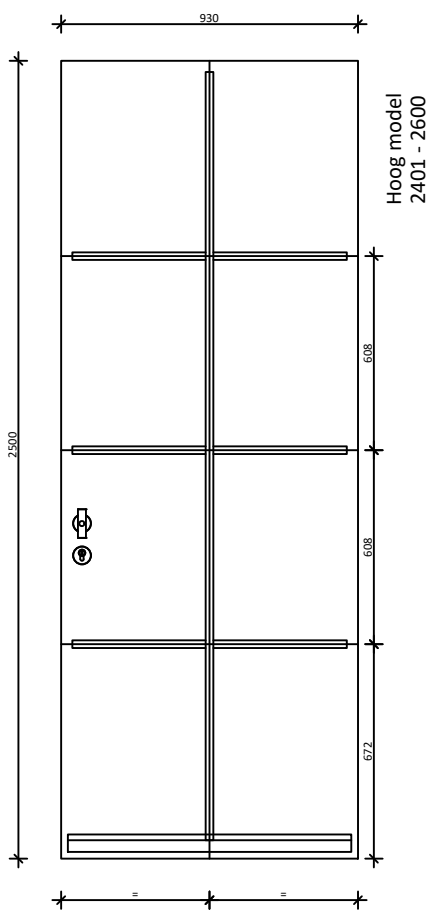
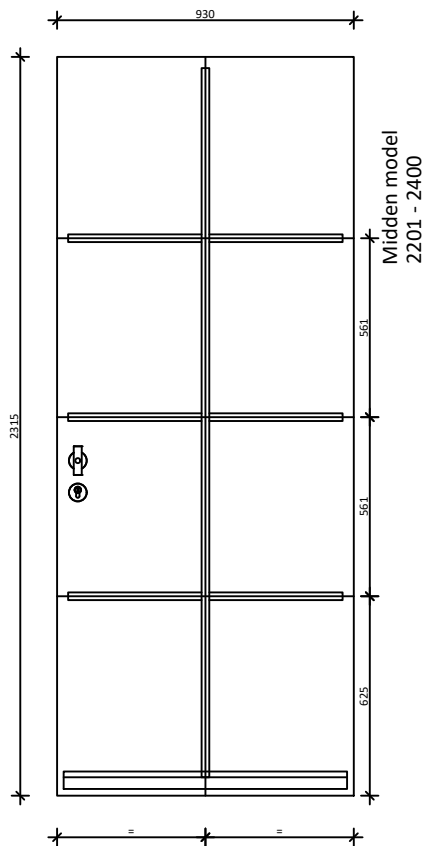
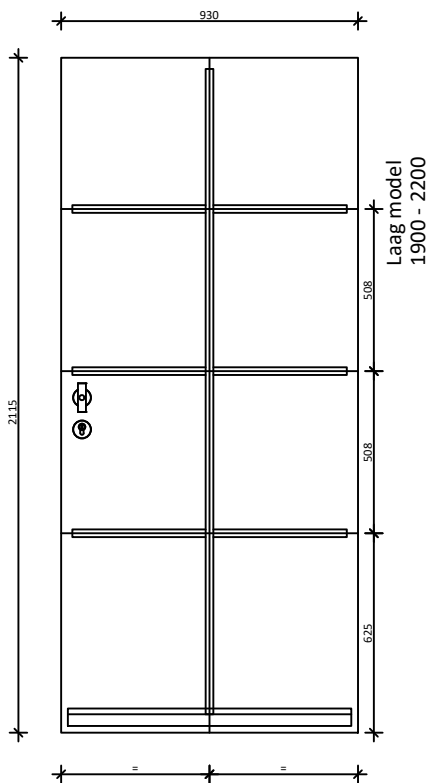

DATUM:
20-02-2024

GEWIJZIGD:

CALCULATIENR:

TEKENINGNR:
20240220-948-01

MODEL:
94802

HOUTSOORT:

KEGRO | DEUREN

KLANT/PROJECT:
Model 94802 Overzicht

DCM NUMMER:

AANVRAAG:

SCHAAL:

GETEKEND:
KF

LEVERWEEK:

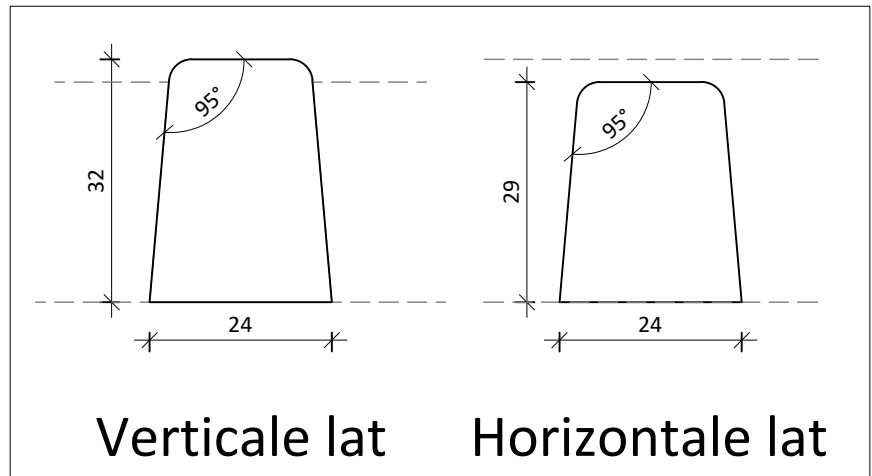
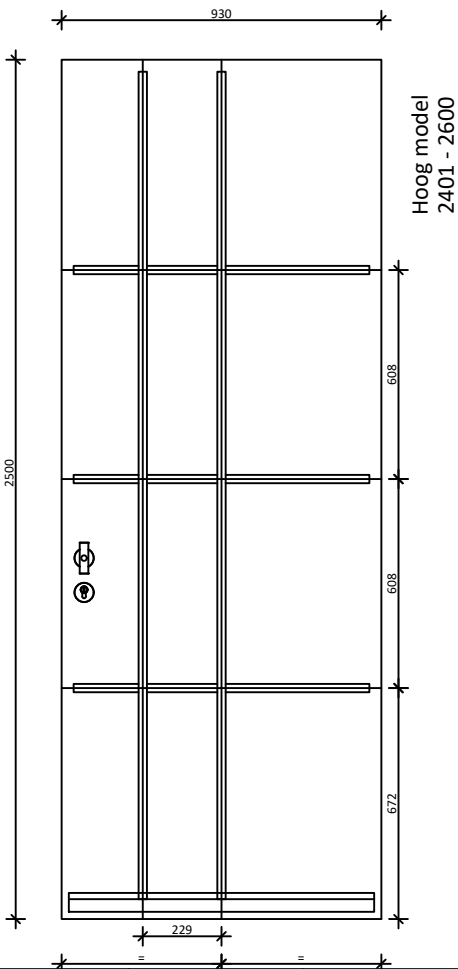
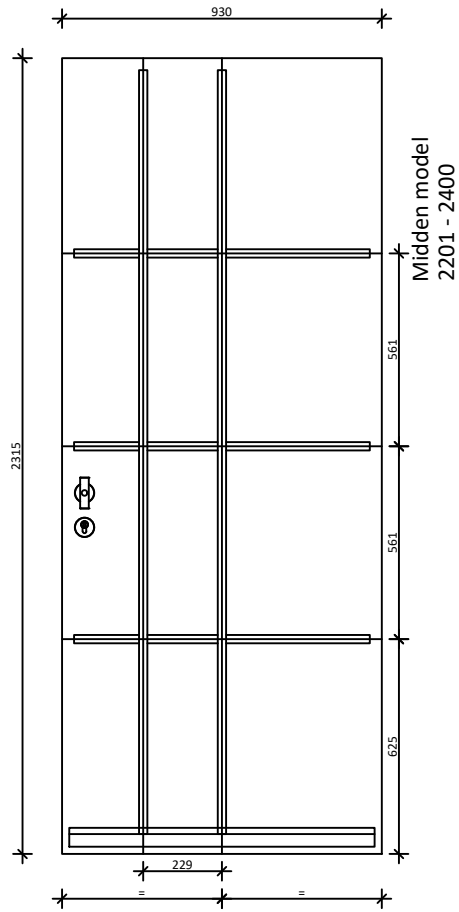
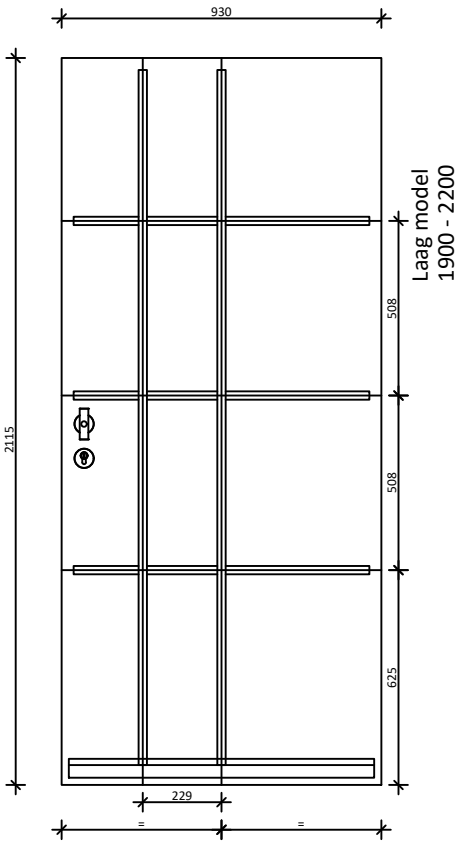

DATUM: 20-02-2024	GEWIJZIGD:	CALCULATIENR:	TEKENINGNR: 20240220-948-01	MODEL: 94803	HOUTSOORT:
			KLANT/PROJECT: Model 94803 Overzicht		DCM NUMMER:
			AANVRAAG:	SCHAAL:	GETEKEND: KF

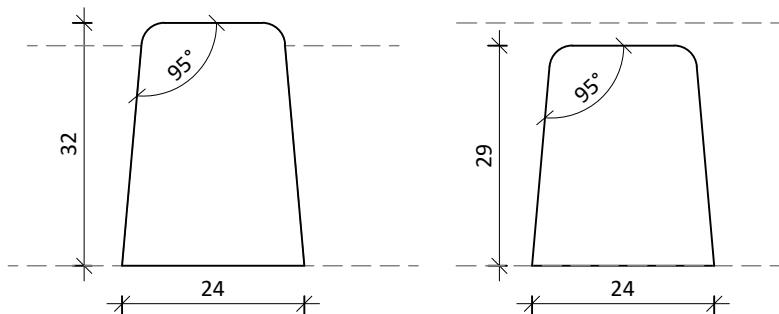
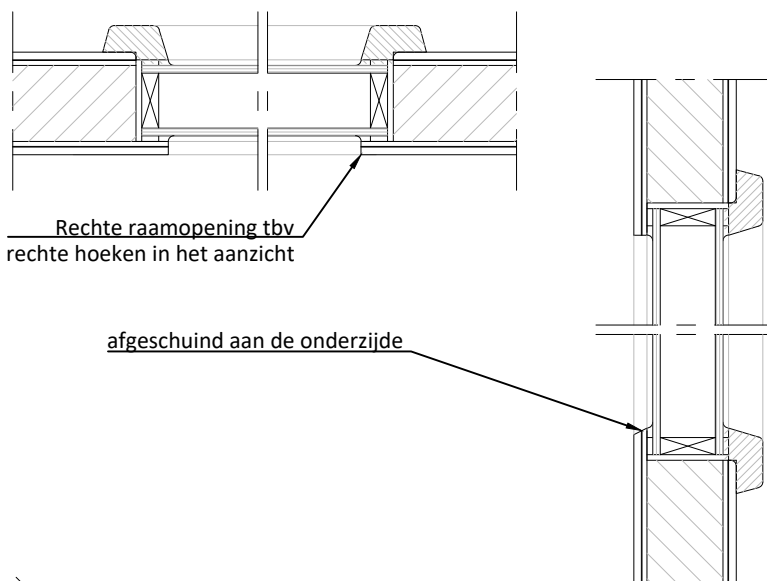
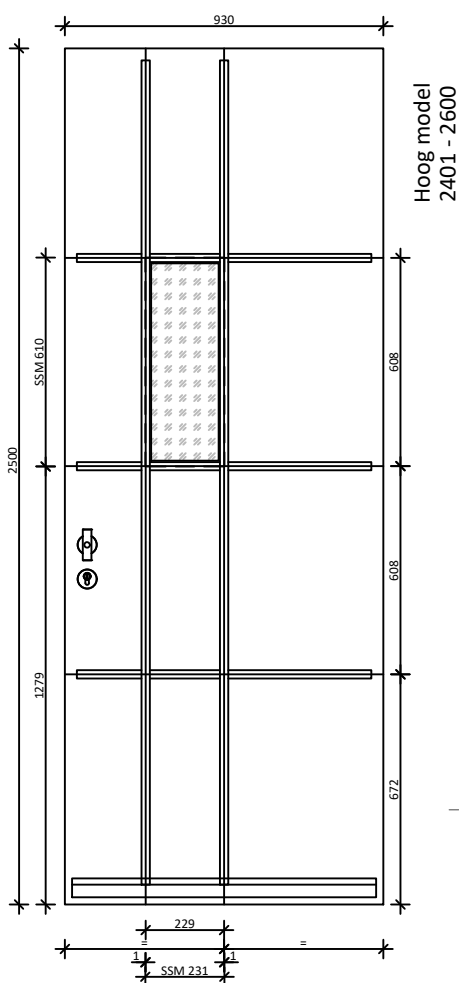
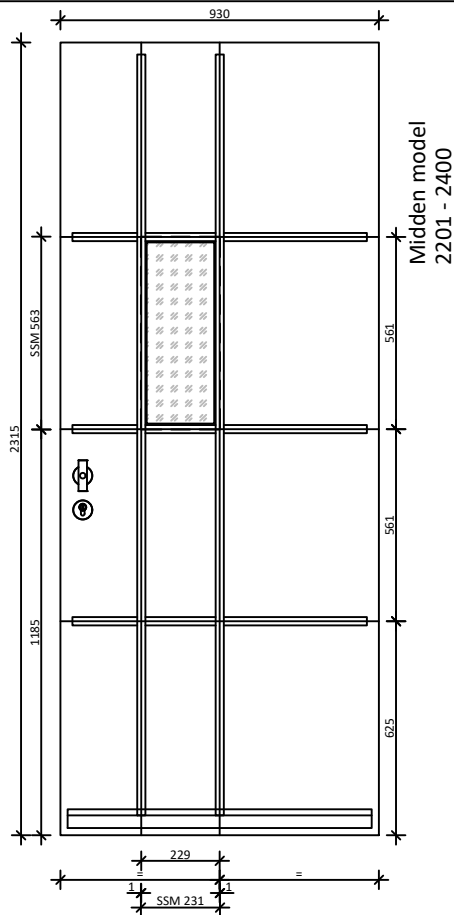
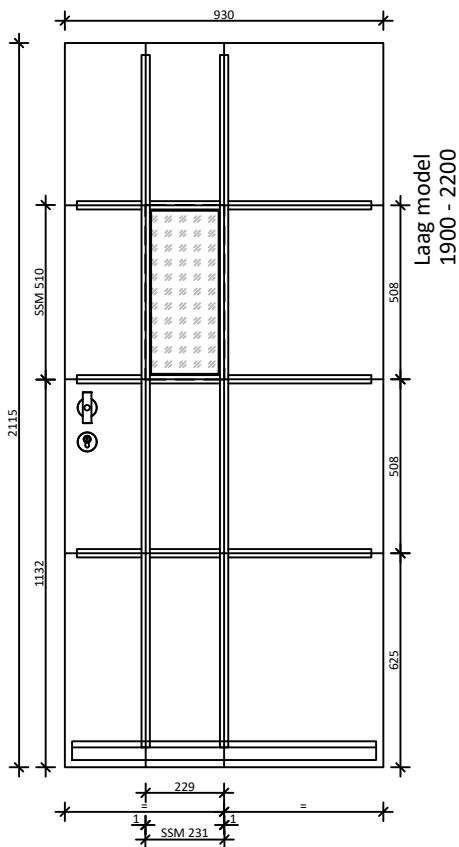

Verticale lat

Horizontale lat

DATUM:
20-02-2024

GEWIJZIGD:

CALCULATIENR:

TEKENINGNR:
20240220-948-01

MODEL:
94804

HOUSOORT:

KEGRO | DEUREN

KLANT/PROJECT:
Model 94804 Overzicht

DCM NUMMER:

AANVRAAG:

SCHAAL:

GETEKEND:
KF

LEVERWEEK:

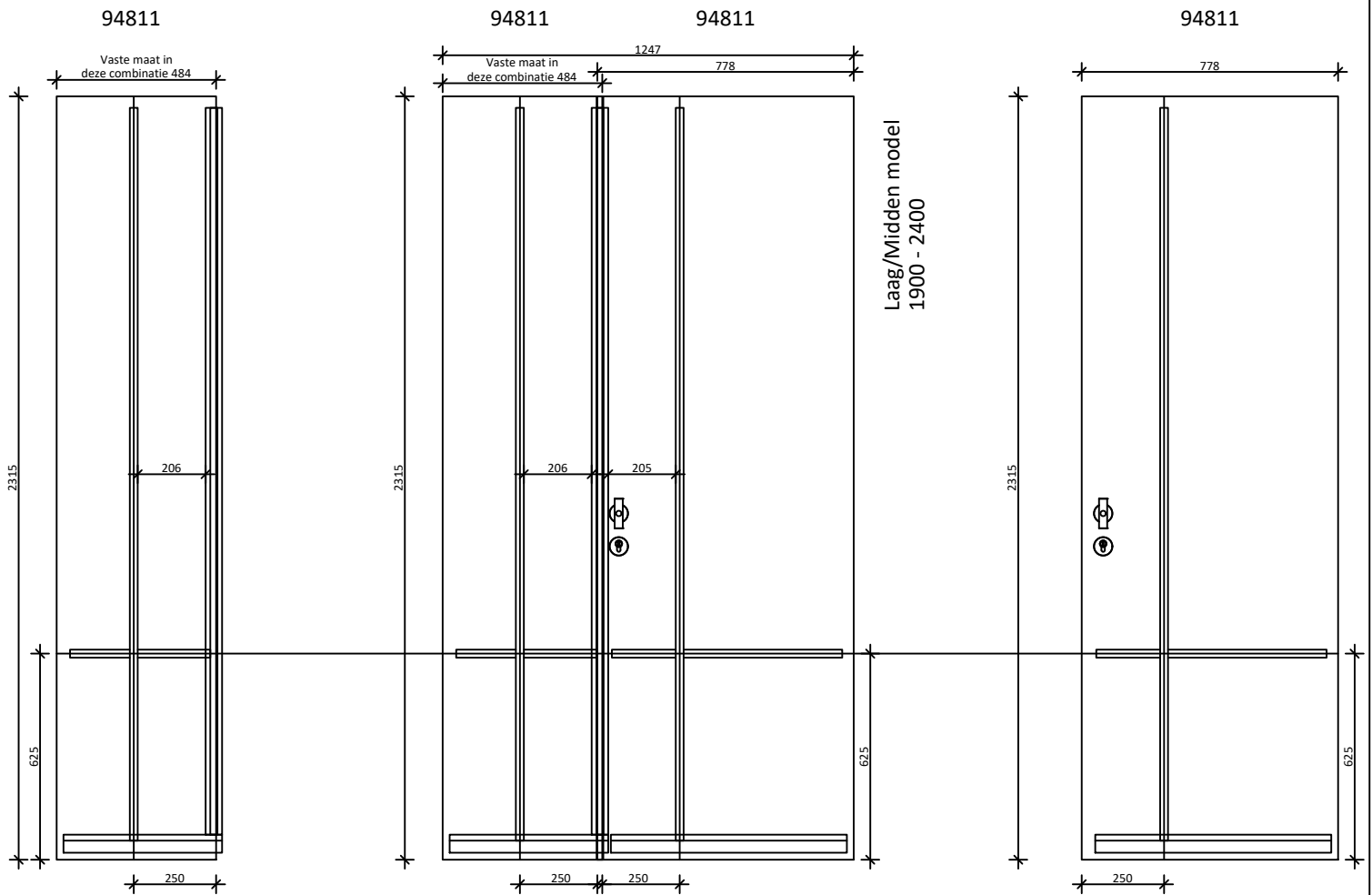

Deze modeltekening is een samenstelling van 2 deuren die samen een modelnummer hebben gekregen omdat het deurstel als een geheel is ontworpen. De beide deur zijn uitgesplitst in eigen tekeningen. zie de modelnummers boven de deur.

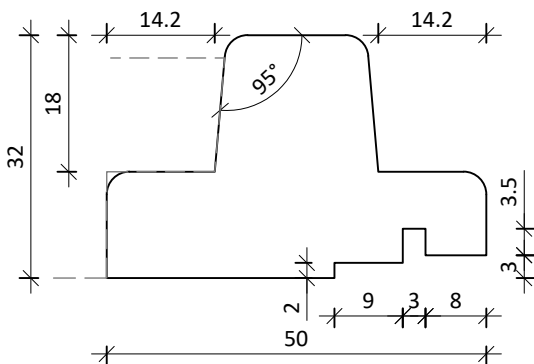

Deklat dubbele deur

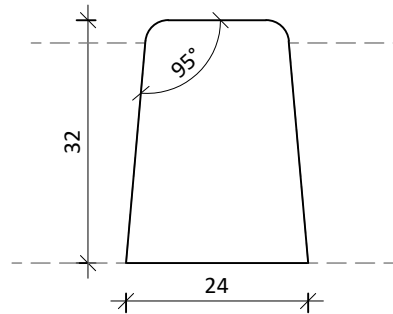

Verticale lat

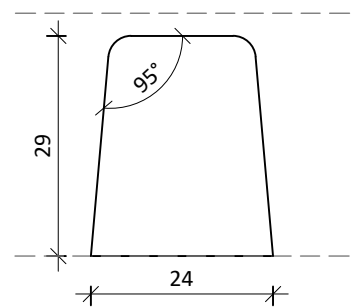

Horizontale lat

DATUM:
20-02-2024

GEWIJZIGD:

CALCULATIENR:

TEKENINGNR:
20240220-948-01

MODEL:
94805

HOUTSOORT:

KEGRO | DEUREN

KLANT/PROJECT:
Model 94805 Overzicht

DCM NUMMER:

AANVRAAG:

SCHAAL:

GETEKEND:
KF

LEVERWEEK:

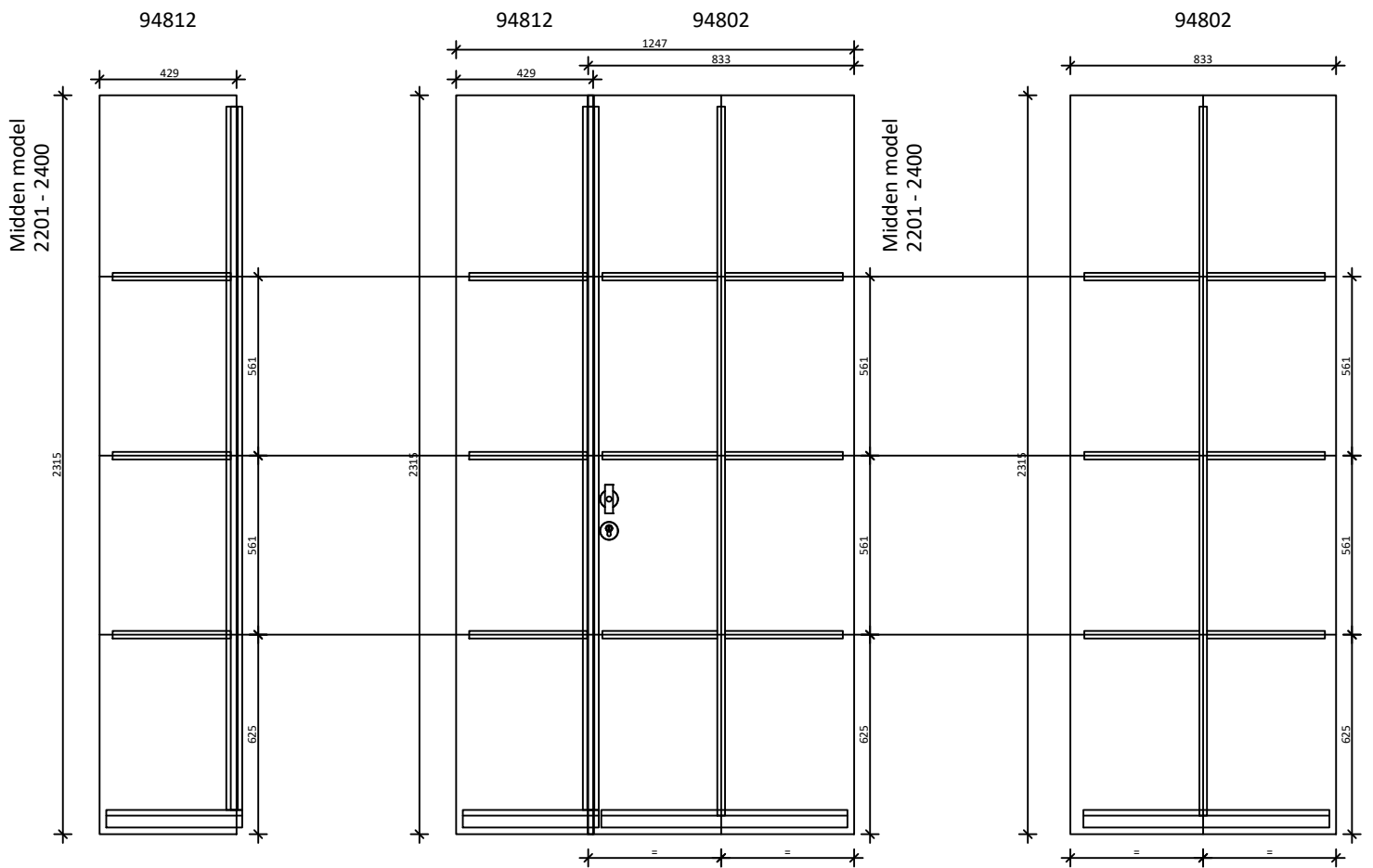

Deze modeltekening is een samenstelling van 2 deuren die samen een modelnummer hebben gekregen omdat het deurstel als een geheel is ontworpen. De beide deur zijn uitgesplitst in eigen tekeningen. zie de modelnummers boven de deur.

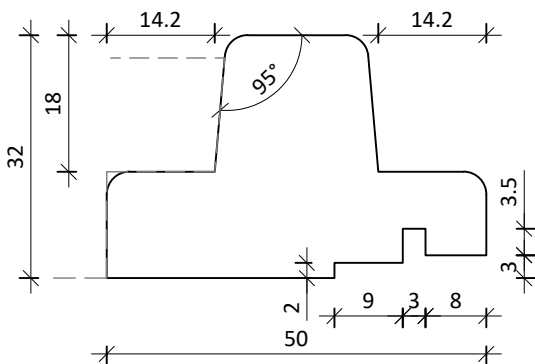

Deklat dubbele deur

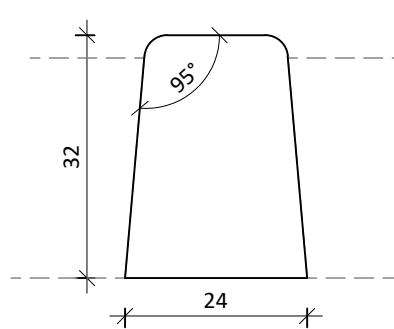

Verticale lat

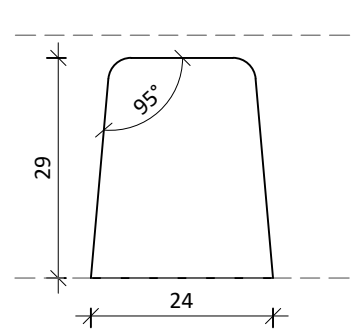

Horizontale lat

DATUM: 20-02-2024	GEWIJZIGD:	CALCULATIENR:	TEKENINGNR: 20240220-948-01	MODEL: 94806	HOUTSOORT:
			KLANT/PROJECT: Model 94806 Overzicht		DCM NUMMER:
			AANVRAAG:	SCHAAL:	GETEKEND: KF

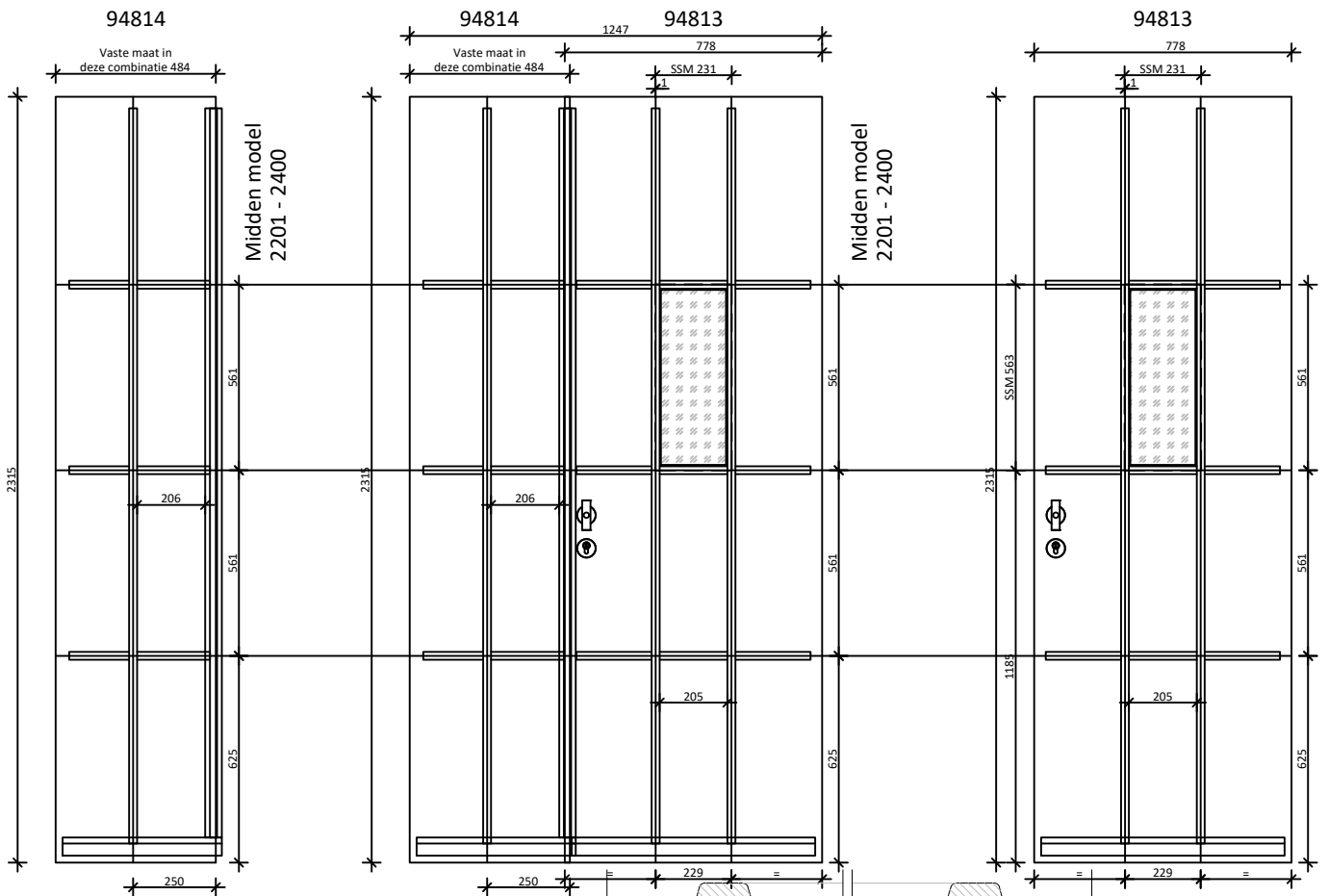

Rechte raamopening tbv
rechte hoeken in het aanzicht

afgeschuind aan de onderzijde

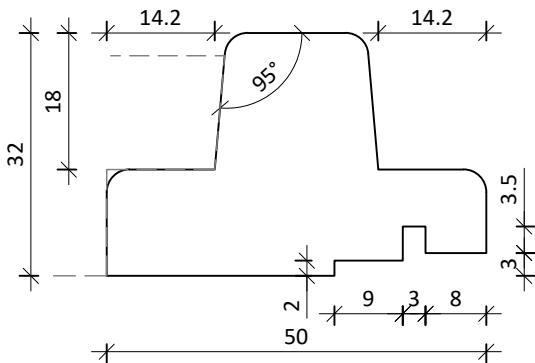

Deklat dubbele deur

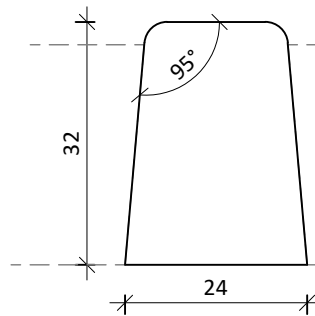

Verticale lat

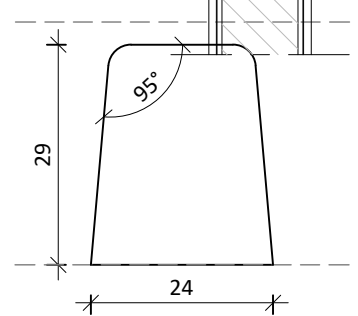

Horizontale lat

DATUM:
20-02-2024

GEWIJZIGD:

CALCULATIENR:

TEKENINGNR:
20240220-948-01

MODEL:
94807

HOUSOORT:

KEGRO | DEUREN

KLANT/PROJECT:
Model 94807 Overzicht

DCM NUMMER:

AANVRAAG:

SCHAAL:

GETEKEND:
KF

LEVERWEEK:

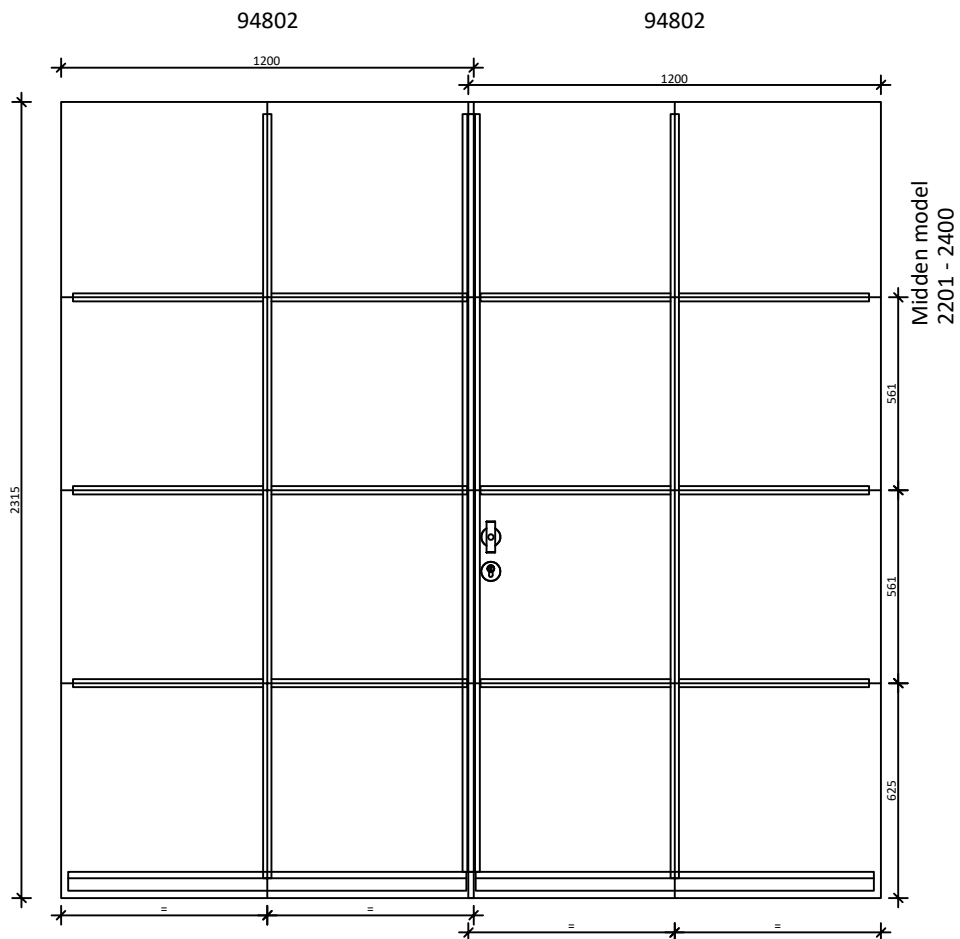

Deze modeltekening is een samenstelling van 2 deuren die samen een modelnummer hebben gekregen omdat het deurstel als een geheel is ontworpen. De beide deur zijn uitgesplitst in eigen tekeningen. zie de modelnummers boven de deur.

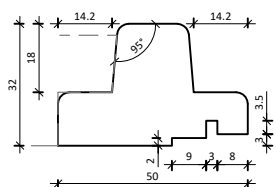

Deklat dubbele deur

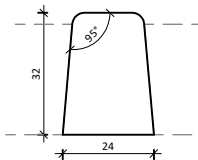

Verticale lat

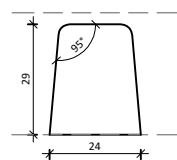

Horizontale lat

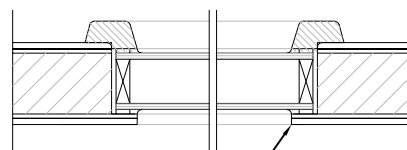

Rechte raamopening tbv
rechte hoeken in het aanzicht

afgeschuind aan de onderzijde

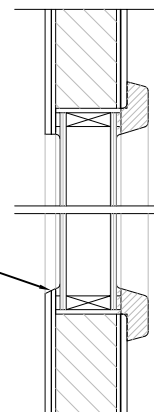

DATUM:
20-02-2024

GEWIJZIGD:

CALCULATIENR:

TEKENINGNR:
20240220-948-01

MODEL:
94809

HOUTSOORT:

KEGRO | DEUREN

KLANT/PROJECT:
Model 94809 Overzicht

DCM NUMMER:

AANVRAAG:

SCHAAL:

GETEKEND:
KF

LEVERWEEK:

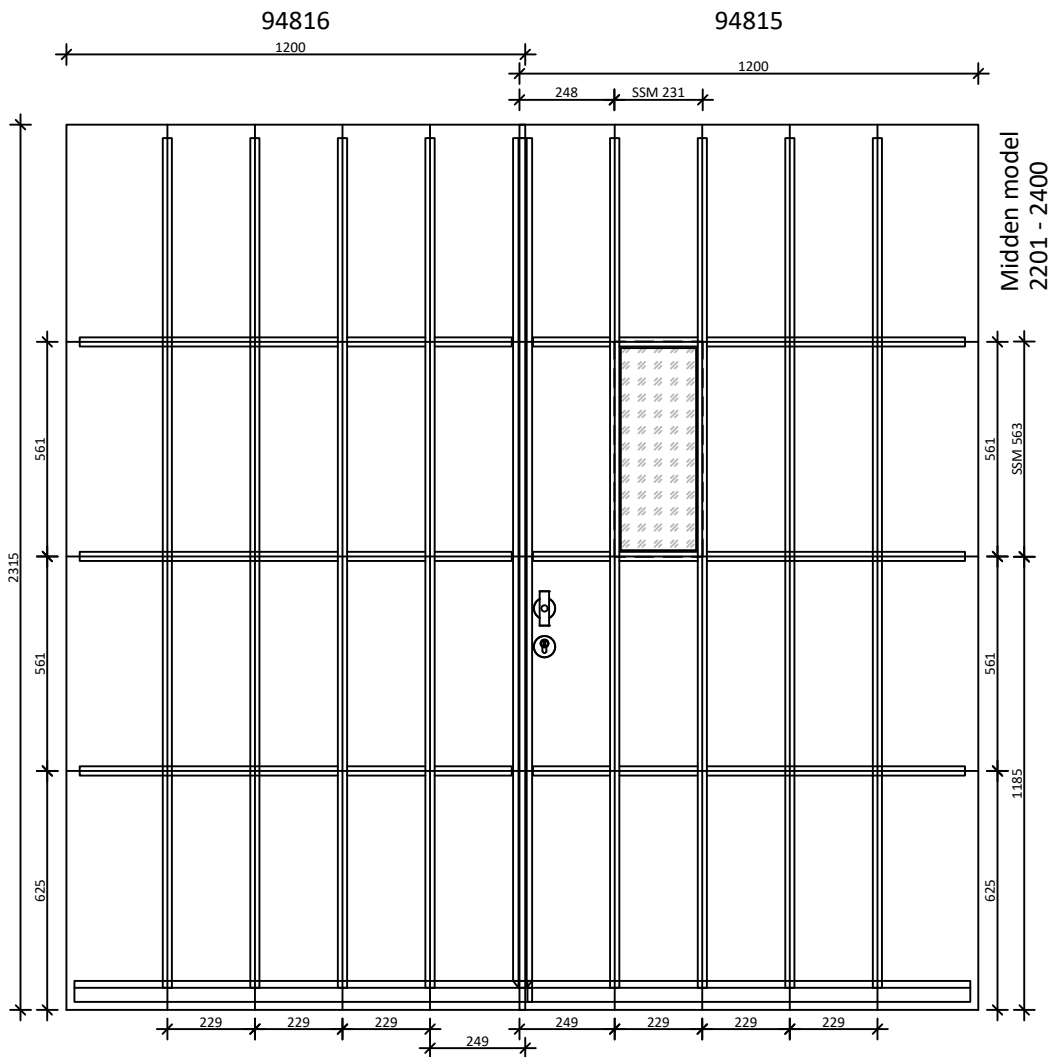

Deze modeltekening is een samenstelling van 2 deuren die samen een modelnummer hebben gekregen omdat het deurstel als een geheel is ontworpen. De beide deur zijn uitgesplitst in eigen tekeningen. zie de modelnummers boven de deur.

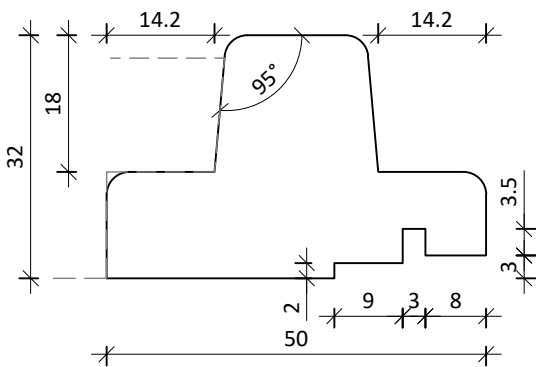

Deklat dubbele deur

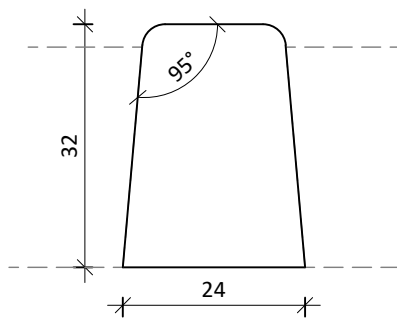

Verticale lat

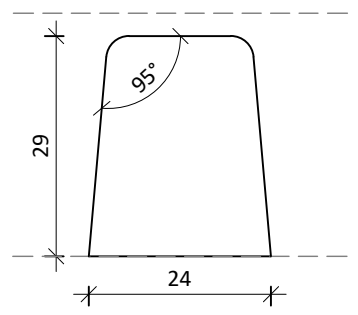

Horizontale lat

DATUM: 20-02-2024	GEWIJZIGD:	CALCULATIENR:	TEKENINGNR: 20240220-948-01	MODEL: 94810	HOUSOORT:
			KLANT/PROJECT: Model 94810 Overzicht		DCM NUMMER:
			AANVRAAG:	SCHAAL:	GETEKEND: KF

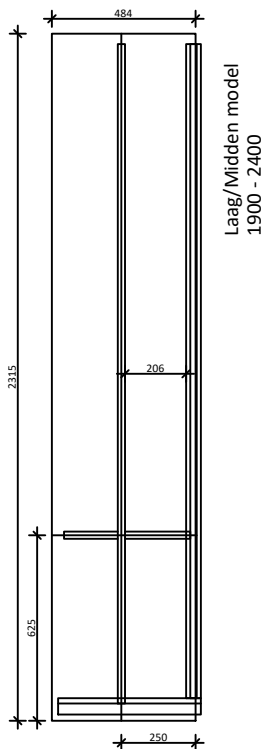

Laag/Midden model
1900 - 2400

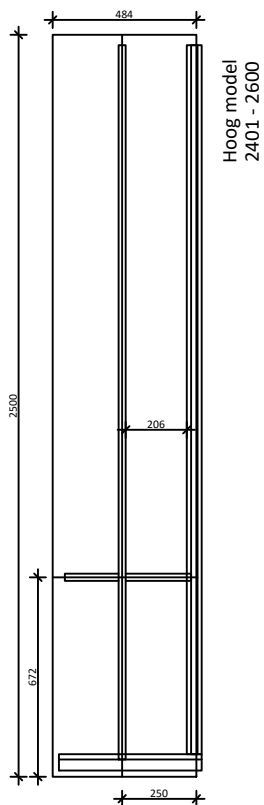

Hoog model
2401 - 2600

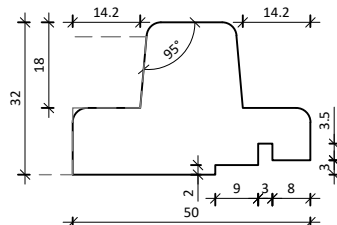

Deklat dubbele deur

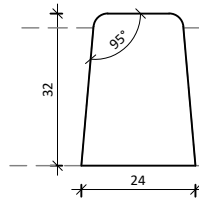

Verticale lat

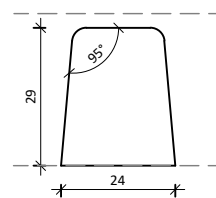

Horizontale lat

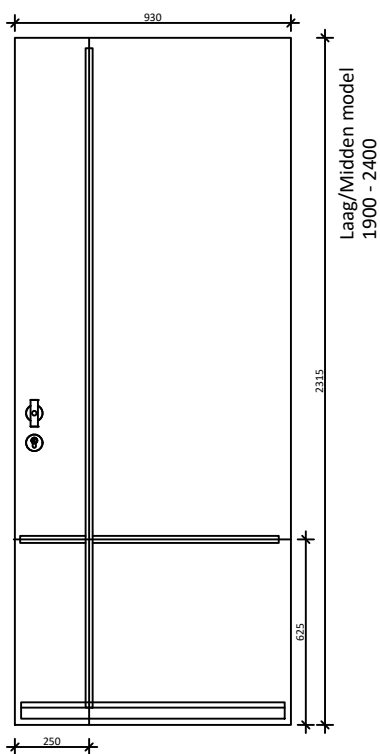

Laag/Midden model
1900 - 2400

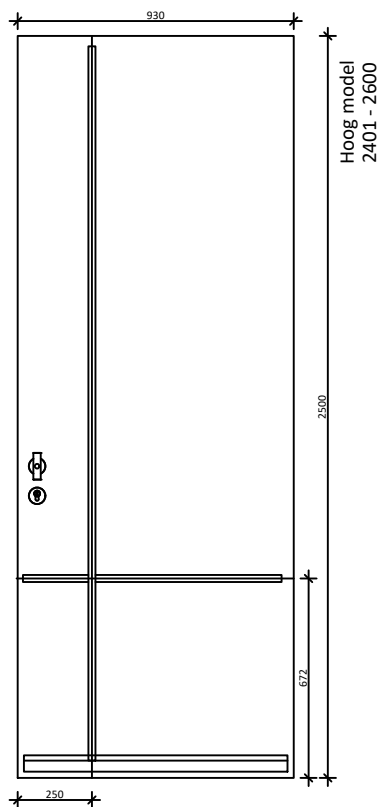

Hoog model
2401 - 2600

Deze deur is onderdeel van een vast deurstel en wordt altijd in die combinatie toegepast. Zie onder van welk deurstel deze deur onderdeel is.

DATUM:
20-02-2024

GEWIJZIGD:

CALCULATIENR:

TEKENINGNR:
20240220-948-01

MODEL:
94811

HOUSOORT:

KEGRO | DEUREN

KLANT/PROJECT:
Model 94811 Overzicht / onderdeel van 94805

DCM NUMMER:

AANVRAAG:

SCHAAL:

GETEKEND:
KF

LEVERWEEK:

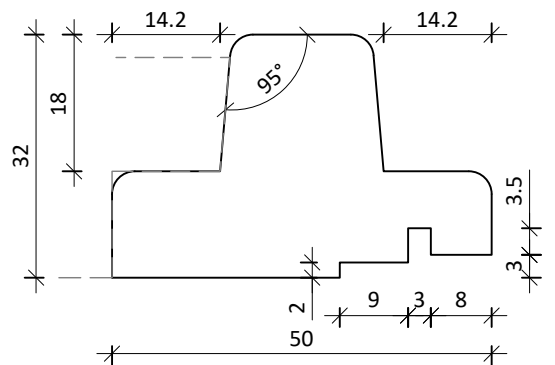
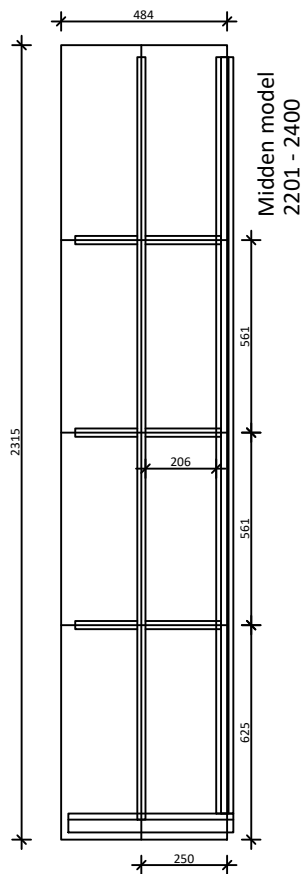
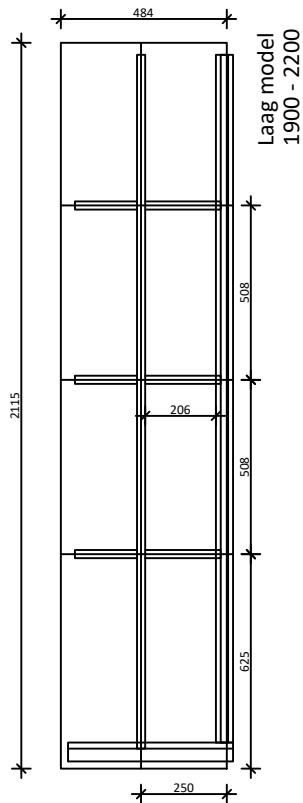

Deklat dubbele deur

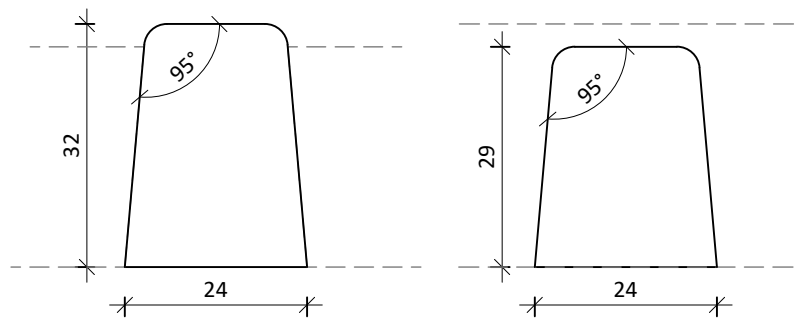
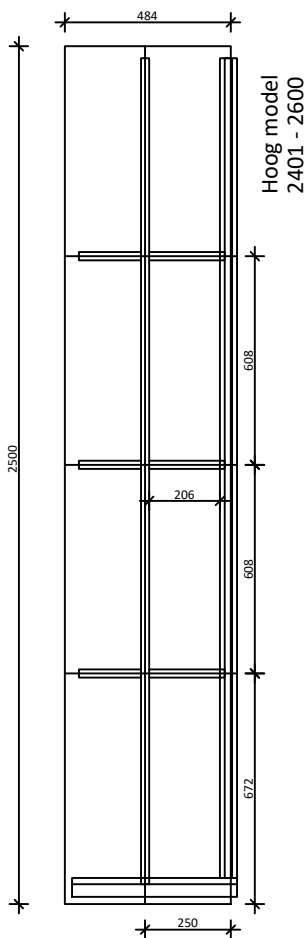

Verticale lat

Horizontale lat

Deze deur is onderdeel van een vast deurstel en wordt altijd in die combinatie toegepast. Zie onder van welk deurstel deze deur onderdeel is.

DATUM:
20-02-2024

GEWIJZIGD:

CALCULATIENR:

TEKENINGNR:
20240220-948-01

MODEL:
94812

HOUTSOORT:

KEGRO | DEUREN

KLANT/PROJECT:
Model 94812 Overzicht / onderdeel van 94806

DCM NUMMER:

AANVRAAG:

SCHAAL:

GETEKEND:
KF

LEVERWEEK:

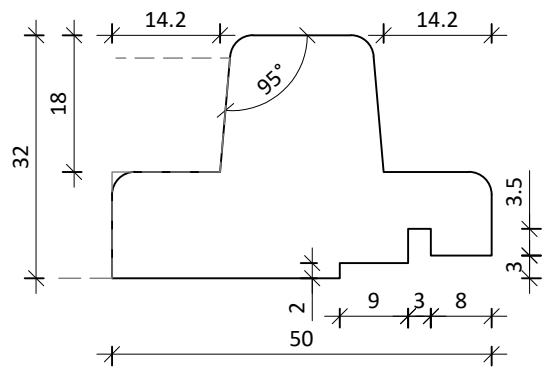
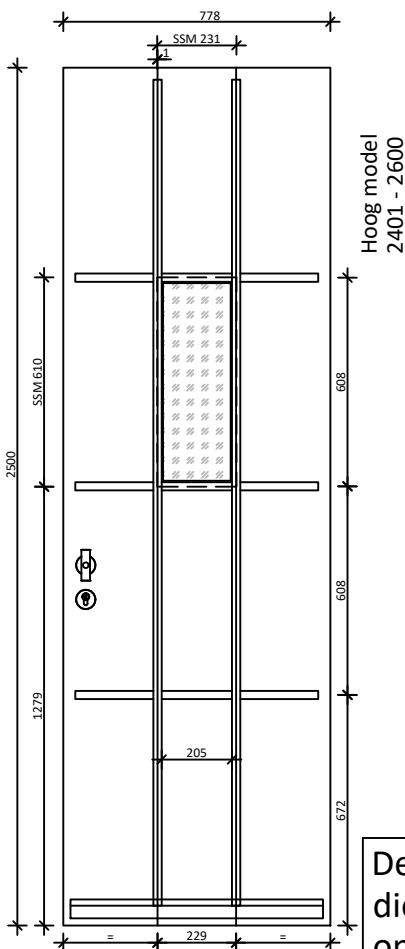
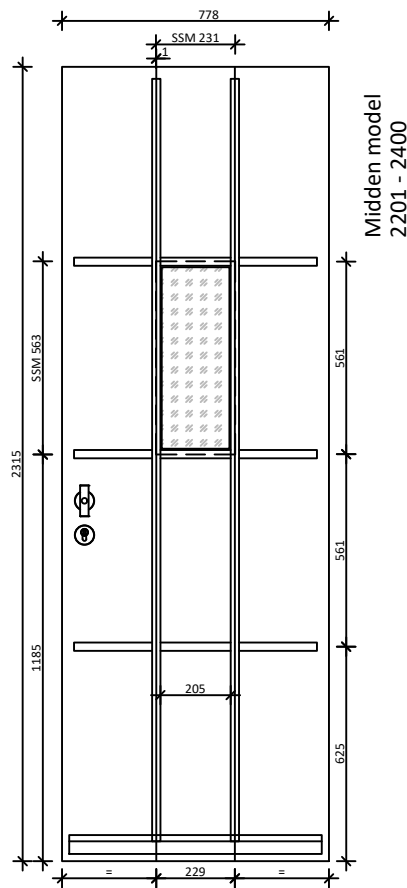
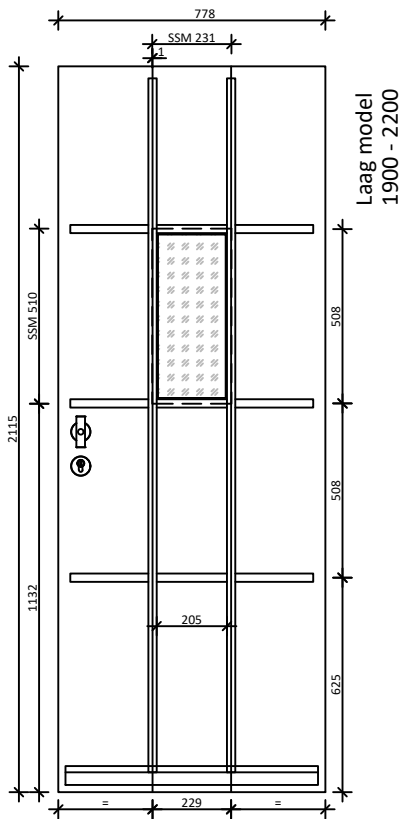

Deklat dubbele deur

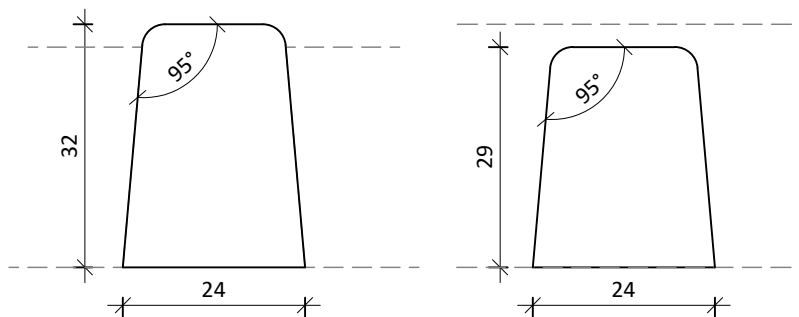

Verticale lat

Horizontale lat

Deze deur is onderdeel van een vast deurstel en wordt altijd in die combinatie toegepast. Zie onder van welk deurstel deze deur onderdeel is.

DATUM:
20-02-2024

GEWIJZIGD:

CALCULATIENR:

TEKENINGNR:
20240220-948-01

MODEL:
94813

HOUSOORT:

KEGRO | DEUREN

KLANT/PROJECT:
Model 94813 Overzicht / onderdeel van 94807

DCM NUMMER:

AANVRAAG:

SCHAAL:

GETEKEND:
KF

LEVERWEEK:

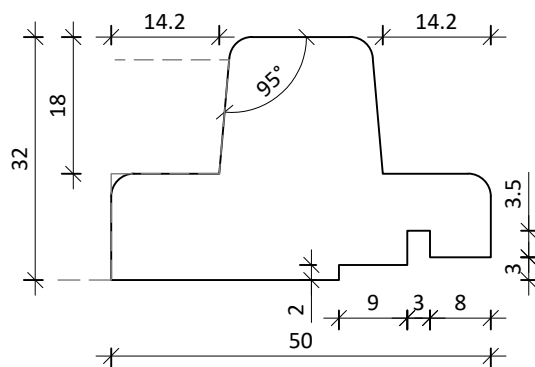
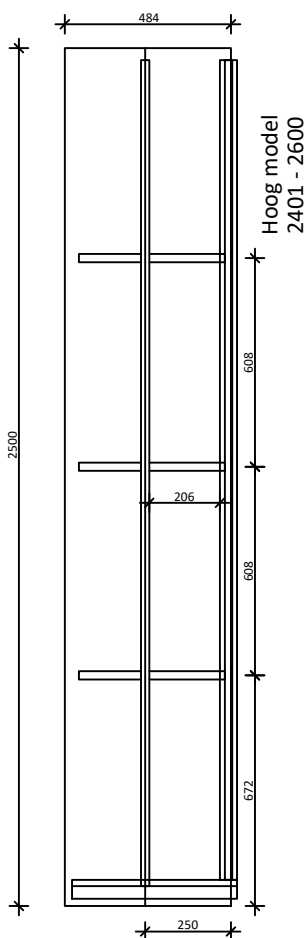
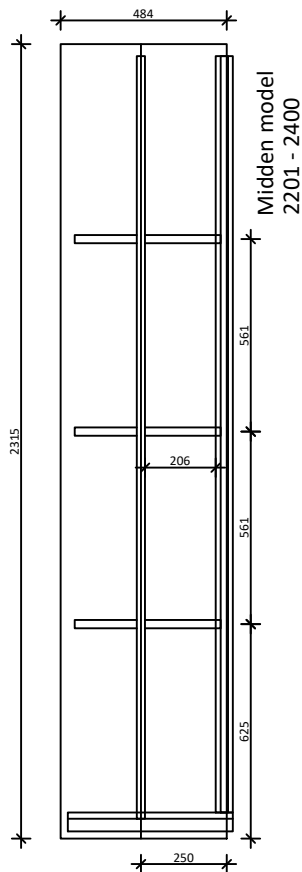
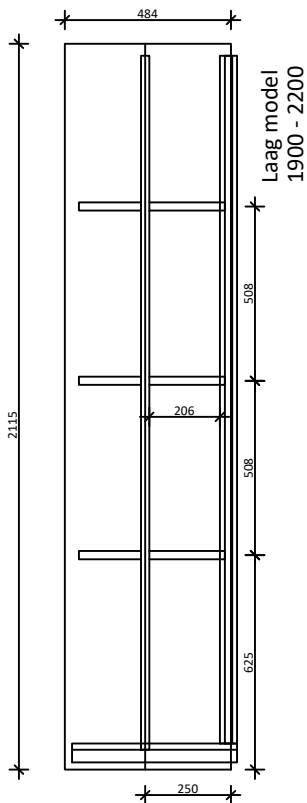

Deklat dubbele deur

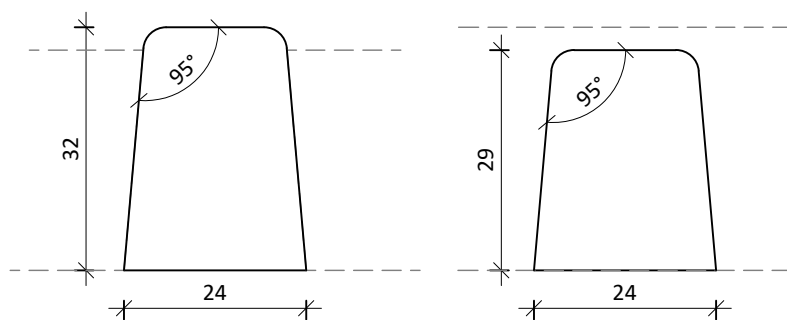

Verticale lat Horizontale lat

Deze deur is onderdeel van een vast deurstel en wordt altijd in die combinatie toegepast. Zie onder van welk deurstel deze deur onderdeel is.

DATUM:
20-02-2024

GEWIJZIGD:

CALCULATIENR:

TEKENINGNR:
20240220-948-01

MODEL:
94814

HOUSOORT:

KEGRO | DEUREN

KLANT/PROJECT:
Model 94814 Overzicht / onderdeel van 94807

DCM NUMMER:

AANVRAAG:

SCHAAL:

GETEKEND:
KF

LEVERWEEK:

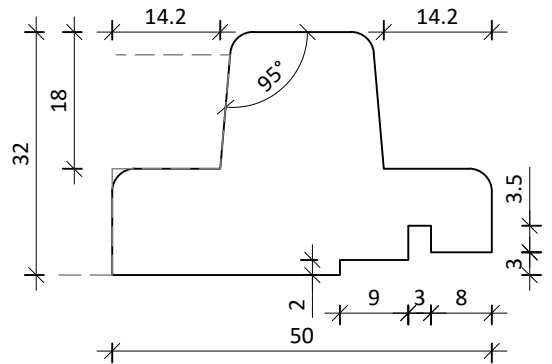
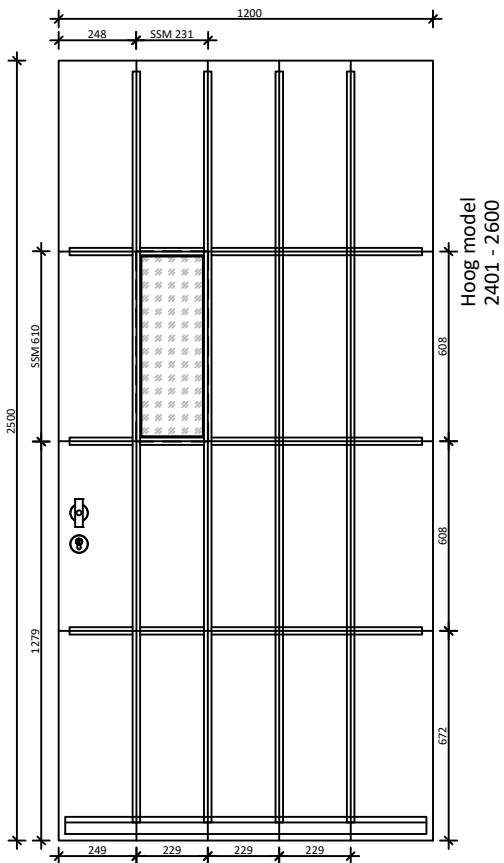
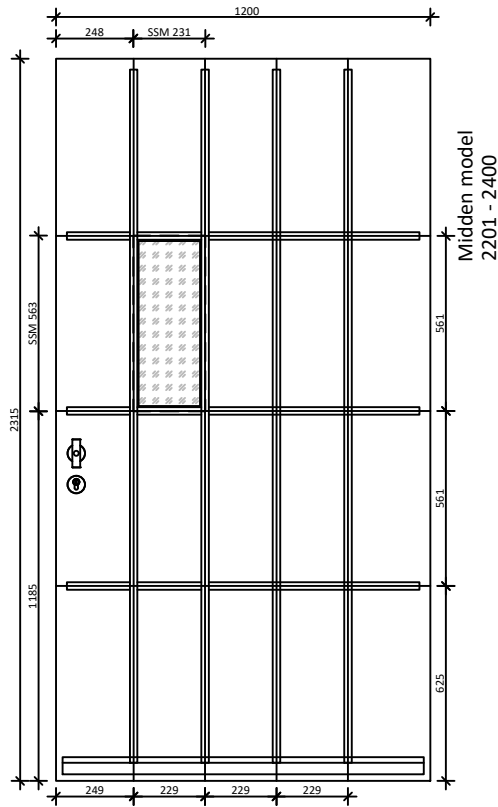
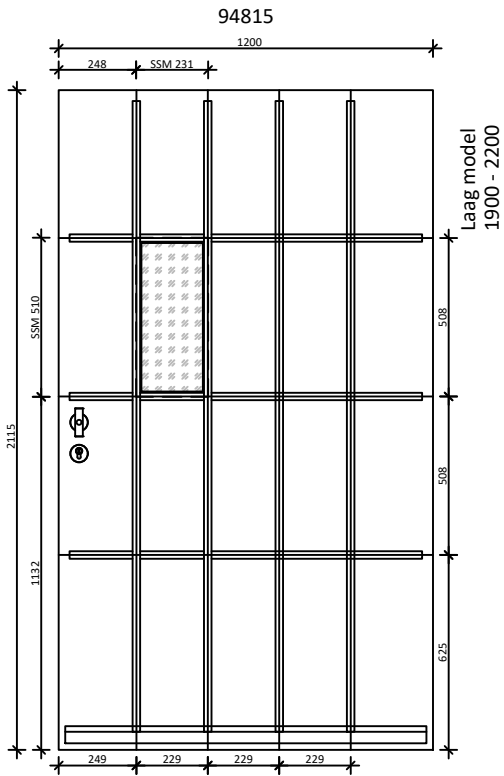

Deklat dubbele deur

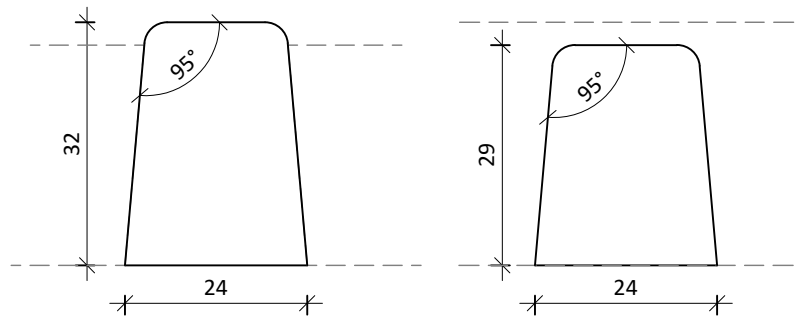

Verticale lat

Horizontale lat

Deze deur is onderdeel van een vast deurstel en wordt altijd in die combinatie toegepast. Zie onder van welk deurstel deze deur onderdeel is.

DATUM:
20-02-2024

GEWIJZIGD:

CALCULATIENR:

TEKENINGNR:
20240220-948-01

MODEL:
94815

HOUSOORT:

KEGRO | DEUREN

KLANT/PROJECT:
Model 94815 Overzicht / onderdeel van 94810

DCM NUMMER:

AANVRAAG:

SCHAAL:

GETEKEND:
KF

LEVERWEEK:

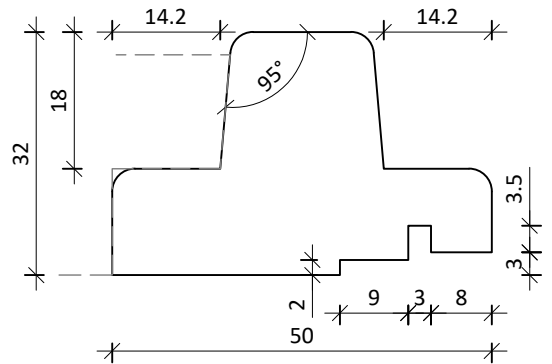
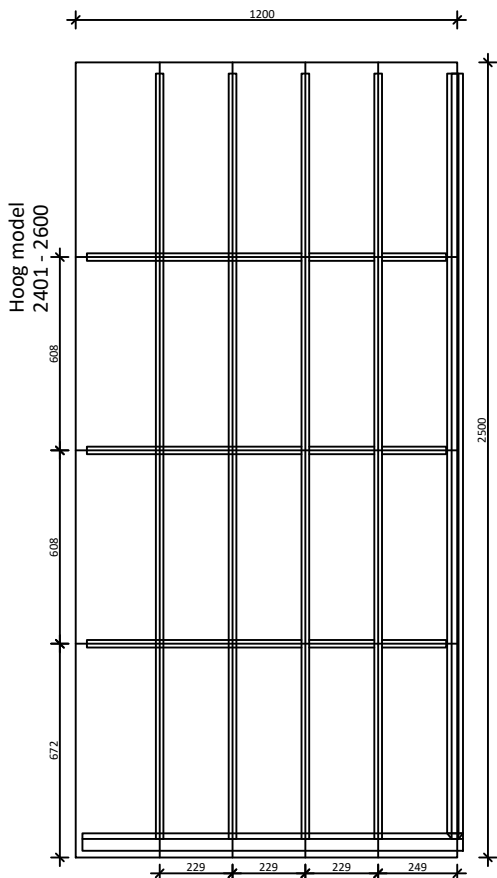
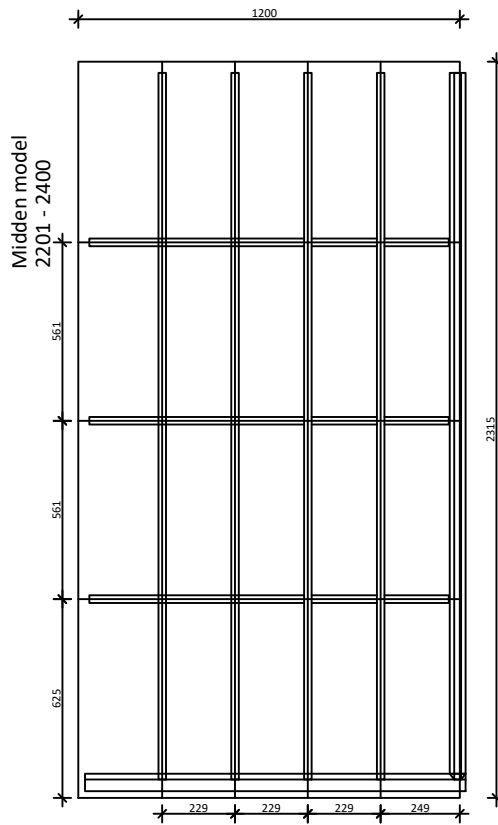
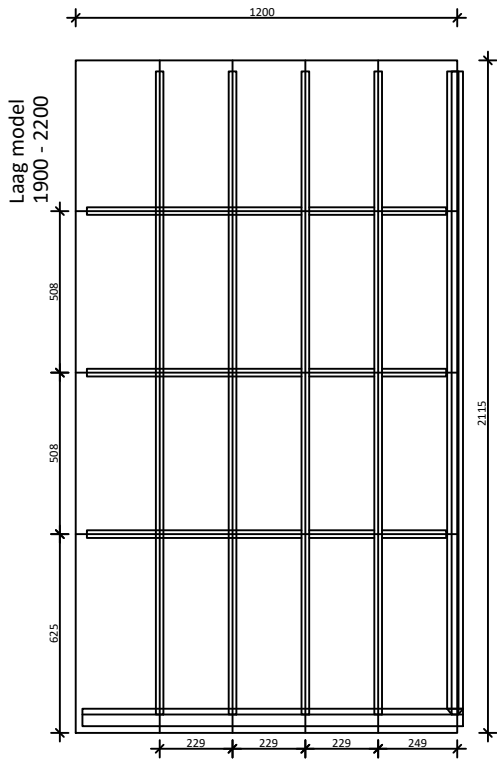

Deklat dubbele deur

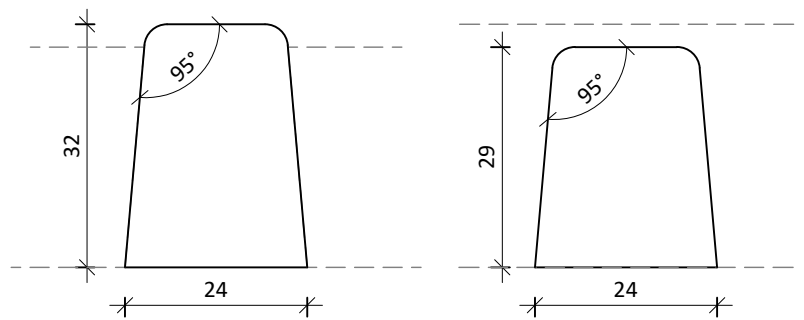

Verticale lat

Horizontale lat

Deze deur is onderdeel van een vast deurstel en wordt altijd in die combinatie toegepast. Zie onder van welk deurstel deze deur onderdeel is.

DATUM:
20-02-2024

GEWIJZIGD:

CALCULATIENR:

TEKENINGNR:
20240220-948-01

MODEL:
94816

HOUSOORT:

KEGRO | DEUREN

KLANT/PROJECT:
Model 94816 Overzicht / onderdeel van 94810

DCM NUMMER:

AANVRAAG:

SCHAAL:

GETEKEND:
KF

LEVERWEEK:

Wij bieden toegang

BEZOEKADRES
Industrieweg 25
6562 AP Groesbeek
+31 (0)24 399 95 55
info@kegro.nl
www.kegro.nl

SOCIAL MEDIA
 KegroDeuren
 @kegrodeuren
 kegro-Deuren

KEGRO | DEUREN